



European  
Commission

JRC SCIENCE AND POLICY REPORTS

# Eurocodes: Background & Applications Structural Fire Design

*Worked examples*

Authors:

O.Vassart, B.Zhao, L.G.Cajot, F.Robert, U.Meyer,  
A.Frangi

Editors:

M.Poljanšek, B.Nikolova, L.Sousa, S.Dimova, A.Pinto

2014

Report EUR 26698 EN

Joint  
Research  
Centre

European Commission  
Joint Research Centre  
Institute for the Protection and Security of the Citizen

Contact information

Address: Joint Research Centre, Via Enrico Fermi 2749, 21027 Ispra (VA), Italy, TP 480  
E-mail: [eurocodes@jrc.ec.europa.eu](mailto:eurocodes@jrc.ec.europa.eu)  
Tel.: +39 0332 78 9989

<https://ec.europa.eu/jrc>

Legal Notice

This publication is a Science and Policy Report by the Joint Research Centre, the European Commission's in-house science service. It aims to provide evidence-based scientific support to the European policy-making process. The scientific output expressed does not imply a policy position of the European Commission. Neither the European Commission nor any person acting on behalf of the Commission is responsible for the use which might be made of this publication.

All images © European Union 2014

JRC90239

EUR 26698 EN

ISBN 978-92-79-38671-8

ISSN 1831-9424

doi:10.2788/85432

Luxembourg: Publications Office of the European Union, 2014

© European Union, 2014

Reproduction is authorised provided the source is acknowledged.

Abstract

This document is a report with worked examples presenting the fire resistance assessment of structures according to the Eurocodes. The authors were involved in the preparation and/or assessment of the Eurocodes structural fire design parts. Each chapter of the report focuses on a specific structural material (i.e. steel, concrete, masonry, etc.) and addresses the principles and design methods followed by worked example(s). The provided information illustrates the basic design methods through examples of application. It will allow any designer to get a good understanding about the fundamentals of the fire parts of the Eurocodes and to carry out fire resistance assessments of various structures.

The materials were prepared and presented at the workshop "Eurocodes: Structural Fire Design" held on 27-28 November 2012 in Brussels, Belgium. The workshop was organized by JRC with the support of DG ENTR and CEN, and in collaboration with CEN/TC250 Horizontal Group - Fire.

The document is part of the Report Series 'Support to the implementation, harmonization and further development of the Eurocodes' prepared by JRC in collaboration with DG ENTR and CEN/TC250 "Structural Eurocodes".

## CONTENTS

<b>List of authors and editors .....</b>	<b>xi</b>
<b>Foreword.....</b>	<b>xiii</b>
<b>CHAPTER 1 .....</b>	<b>1</b>
<b>EN 1991-1-2. BASIC DESIGN METHODS AND WORKED EXAMPLES</b>	
<b>1.1 Introduction .....</b>	<b>3</b>
<b>1.2 Methodology.....</b>	<b>5</b>
1.2.1 Introduction.....	5
1.2.2 Objectives.....	5
1.2.3 Fire development calculation method .....	6
1.2.4 Structural fire behaviour.....	7
1.2.5 Required data.....	7
<b>1.3 Characteristics of the fire compartment.....</b>	<b>7</b>
1.3.1 Introduction.....	7
1.3.2 Boundary elements of the compartment.....	8
1.3.3 Wall: thermal characteristics .....	8
1.3.4 Opening characteristics .....	10
1.3.5 Mechanical ventilation .....	10
<b>1.4 Characteristics of the fire.....</b>	<b>10</b>
1.4.1 Fire load.....	11
1.4.1.1 Deterministic approach .....	11
1.4.1.2 Statistical approach .....	13
1.4.2 Type of fire.....	13
1.4.3 Design fire.....	14
1.4.3.1 Fuel control and ventilation control fires.....	14
1.4.3.2 Design RHR.....	15
1.4.3.3 Experimental data .....	16
<b>1.5 Probabilistic aspect.....</b>	<b>17</b>
1.5.1 Introduction.....	17
1.5.2 Statistics .....	18

1.5.3	Probabilities.....	18
1.5.3.1	Event tree analysis .....	18
1.5.3.2	Fire occurrence and fire growth.....	19
1.5.4	Procedure.....	20
1.5.4.1	Determination of the design values of actions and resistances - Safety factor $\gamma$ in the Eurocodes - Principle for normal conditions of use.....	20
1.5.4.2	Target value .....	23
1.5.4.3	Fire design and conditional probability .....	23
1.5.4.4	Design fire load and $\delta$ factor.....	24
<b>1.6</b>	<b>Fire development calculations .....</b>	<b>26</b>
1.6.1	Introduction .....	26
1.6.2	Localised fire.....	26
1.6.2.1	Two-zone models.....	26
1.6.2.2	The Heskestad method.....	28
1.6.2.3	Hasemi's method .....	28
1.6.2.4	Combination of two-zone model and localised fire model .....	30
1.6.3	Fully engulfed fire.....	31
1.6.3.1	Parametric fires .....	32
1.6.3.2	Zone models.....	35
1.6.3.3	One-zone model.....	36
1.6.4	Combination of one-zone and two-zone models. Choice of the model.....	38
<b>1.7</b>	<b>Mechanical actions according to Eurocodes .....</b>	<b>40</b>
<b>1.8</b>	<b>Conclusion .....</b>	<b>41</b>
<b>1.9</b>	<b>Worked example.....</b>	<b>41</b>
1.9.1	Fire developing in a compartment.....	41
1.9.2	Localised Fire.....	54
1.9.3	Rate of Heat Release .....	56
1.9.4	Calculation of the steel temperatures .....	56
<b>CHAPTER 2</b>	<b>.....</b>	<b>61</b>
	<b>FIRE RESISTANCE ASSESSMENT OF STEEL STRUCTURES ACCORDING TO PART 1-2 OF EUROCODE 3 (EN 1993-1-2)</b>	
<b>2.1</b>	<b>Introduction .....</b>	<b>63</b>

<b>2.2</b>	<b>Fire resistance criteria according to the European standards.....</b>	<b>63</b>
<b>2.3</b>	<b>Scope of the fire part of Eurocode 3.....</b>	<b>64</b>
<b>2.4</b>	<b>Necessary basic knowledge to apply Eurocode 3 for fire resistance assessment of steel structures.....</b>	<b>65</b>
2.4.1	Design approaches and design tools of the fire part of Eurocode 3 .....	65
2.4.2	Material properties of steel at elevated temperatures .....	69
2.4.3	Partial factors for fire resistance assessment of steel structures.....	72
<b>2.5</b>	<b>Design procedure with critical temperature method.....</b>	<b>72</b>
2.5.1	Determination of critical temperatures.....	73
2.5.1.1	Step 1: Determination of applied design load to a steel member in the fire situation $E_{fi,d,t}$ .....	73
2.5.1.2	Step 2: Classification of the steel member under the fire situation.....	76
2.5.1.3	Step 3: Calculation of design load-bearing capacity of the steel member at instant 0 of fire $R_{fi,d,0}$ .....	77
2.5.1.4	Step 4: Determination of degree of utilization of the steel member $\mu_0$ .....	77
2.5.1.5	Step 5: Calculation of critical temperature of the steel member $\theta_{cr}$ .....	78
2.5.2	Temperature evaluation of unprotected steel members.....	85
2.5.2.1	Step 6: Calculation of the section factor of unprotected steel members and correction factor for shadow effect .....	85
2.5.2.2	Step 7: Calculation of the heating of unprotected steel members.....	86
2.5.3	Temperature evaluation of insulated steel members .....	88
2.5.3.1	Step 6a: Calculation of section factor of fire protected steel members.....	88
2.5.3.2	Step 7a: Calculation of the heating of fire protected steel members.....	89
2.5.4	Fire resistance verification of steel members .....	90
<b>2.6</b>	<b>Basic principles of simple calculation methods.....</b>	<b>91</b>
2.6.1	Simple calculation methods of steel members without instability .....	91
2.6.2	Simple calculation methods of steel members with instability .....	92
2.6.3	Design recommendations for steel joints .....	93
2.6.4	Design of external steel structures.....	94
<b>2.7</b>	<b>Advanced calculation models.....</b>	<b>95</b>
2.7.1	Application principles of advanced calculation models.....	95
2.7.2	General application rules of fire design by global structural analysis.....	95
2.7.3	Application requirement of advanced calculation model in global structural analysis of steel structures .....	96

2.7.3.1	Strain composition of material model in advanced numerical modelling.....	96
2.7.3.2	Kinematical material model for taking into account of temperature evolution .....	97
2.7.3.3	Principle of step by step iterative solution procedure in advanced numerical calculation.....	98
2.7.4	Application examples of advanced calculation modelling of steel structures.....	98
<b>2.8</b>	<b>Worked examples .....</b>	<b>100</b>
2.8.1	Description of the steel building.....	100
2.8.1.1	Steel structure's arrangement.....	100
2.8.1.2	Loading conditions.....	101
2.8.1.3	Material properties.....	102
2.8.2	General.....	102
2.8.3	Example 1: Simply supported secondary beam under the end support of the continuous slab .....	103
2.8.3.1	Step 1: Design loads in the fire situation .....	103
2.8.3.2	Step 2: Classification of the steel beam .....	105
2.8.3.3	Step 3: Determination of the design resistance of the steel beam at room temperature .....	106
2.8.3.4	Step 4a: Degree of utilisation of the unprotected steel beam.....	106
2.8.3.5	Step 5a: Calculation of the critical temperature of the unprotected beam .....	107
2.8.3.6	Step 6a: Calculation of the section factor of the unprotected steel beam .....	107
2.8.3.7	Step 7a: Calculation of the heating of the unprotected steel beam .....	107
2.8.3.8	Step 4b: Degree of utilisation of the fire protected steel beam .....	108
2.8.3.9	Step 5b: Calculation of the critical temperature of the fire protected beam .....	109
2.8.3.10	Step 6b: Calculation of the section factor of the fire protected steel beam.....	109
2.8.3.11	Step 7b: Calculation of the heating of the steel beam protected with spray material .....	109
2.8.4	Example 2: A Secondary beam under the central support of the continuous slab .....	110
2.8.4.1	Step 1: Design loads in the fire situation .....	111
2.8.4.2	Step 2: Classification of the steel beam .....	111
2.8.4.3	Step 3: Determination of the design resistance of the steel beam at room temperature .....	112
2.8.4.4	Step 4a: Degree of utilisation of the unprotected steel beam.....	114
2.8.4.5	Step 5a: Calculation of the critical temperature of the unprotected beam .....	114
2.8.4.6	Step 6a: Calculation of the section factor of the unprotected steel beam .....	114
2.8.4.7	Step 7a: Calculation of the heating of the unprotected steel beam .....	115
2.8.4.8	Step 4b: Degree of utilisation of the fire protected steel beam .....	116

2.8.4.9	Step 5b: Calculation of the critical temperature of the fire protected beam .....	116
2.8.4.10	Step 6b: Calculation of the section factor of the fire protected steel beam.....	116
2.8.4.11	Step 7b: Calculation of the heating of the steel beam protected with spray material .....	116
2.8.5	Example 3: Simply supported central main beam.....	117
2.8.5.1	Step 1: Design loads in the fire situation .....	117
2.8.5.2	Step 2: Classification of the steel beam .....	119
2.8.5.3	Step 3: Determination of the design resistance of the steel beam at room temperature .....	120
2.8.5.4	Step 4a: Degree of utilisation of the unprotected steel beam.....	120
2.8.5.5	Step 5a: Calculation of the critical temperature of the unprotected beam .....	121
2.8.5.6	Step 6a: Calculation of the section factor of the unprotected steel beam .....	121
2.8.5.7	Step 7a: Calculation of the heating of the unprotected steel beam .....	121
2.8.5.8	Step 4b: Degree of utilisation of the fire protected steel beam .....	122
2.8.5.9	Step 5b: Calculation of the critical temperature of the fire protected beam .....	123
2.8.5.10	Step 6b: Calculation of the section factor of the fire protected steel beam.....	123
2.8.5.11	Step 7b: Calculation of the heating of the steel beam protected with spray material .....	123
2.8.6	Example 4: Central column at the ground floor .....	124
2.8.6.1	Step 1: Design load in the fire situation.....	124
2.8.6.2	Step 2: Classification of the steel column.....	126
2.8.6.3	Step 3: Determination of the design resistance of the steel column at room temperature .....	127
2.8.6.4	Step 4: Degree of utilisation of the column .....	127
2.8.6.5	Step 5: Calculation of the critical temperature of the column.....	127
2.8.6.6	Step 6a: Calculation of the section factor of the unprotected steel column .....	128
2.8.6.7	Step 7a: Calculation of the heating of the unprotected steel column .....	128
2.8.6.8	Step 6b: Calculation of the section factor of the fire protected steel column .....	129
2.8.6.9	Step 7b: Calculation of the heating of the steel column protected with spray material .....	129
<b>2.9</b>	<b>Conclusions.....</b>	<b>130</b>
<b>CHAPTER 3</b>	<b>.....</b>	<b>133</b>
<b>EUROCODE 4: DESIGN OF COMPOSITE STEEL AND CONCRETE STRUCTURES.</b>		
<b>PART 1-2: GENERAL RULES – STRUCTURAL FIRE DESIGN</b>		
<b>3.1</b>	<b>Verification of the composite slab .....</b>	<b>135</b>

3.1.1	Objective .....	135
3.1.2	Fire resistance of the composite slab.....	136
3.1.2.1	Geometric parameters and field of application (§4.3.2 - Figure 4.1, EN 1994-1-2) .....	136
3.1.2.2	Fire resistance according to thermal insulation (Annex D - §D.1) .....	137
3.1.2.3	Verification of the bearing capacity .....	139
<b>3.2</b>	<b>Verification of the statically determined composite beam .....</b>	<b>146</b>
3.2.1	Objective .....	146
3.2.2	Fire resistance of the composite beam.....	148
3.2.2.1	Mechanical actions in fire situation (EN 1990, §6.4.3.3) .....	148
3.2.2.2	Classification of the section in fire situation (EN 1993-1-2 , §4.2.2) .....	148
3.2.2.3	Temperature calculation in the cross section (EN 1994-1-2).....	148
3.2.2.4	Verification of the resistance by the moment resistance method (EN 1994-1-2, Annex E) .....	151
3.2.2.5	Critical temperature method (EN 1994-1-2).....	154
3.2.2.6	Verification of the vertical shear resistance (E.4, EN 1994-1-2).....	155
<b>3.3</b>	<b>Verification of the column.....</b>	<b>156</b>
3.3.1	Objective .....	156
3.3.2	Mechanical actions in the fire situation (EN 1991-1-2) .....	157
3.3.3	Use of the tabulated data (EN 1994-1-2, §4.2.3.3, Table 4.6).....	158
3.3.4	Field of application of the simplified method (EN 1994-1-2, annex G) .....	158
3.3.5	Calculation of the resistance to axial compression according to the weak axis .....	159
3.3.6	Calculation of the resistance to axial compression according to the strong axis.....	165
<b>3.4</b>	<b>Annex 1 .....</b>	<b>167</b>
<b>3.5</b>	<b>Annex 2.....</b>	<b>168</b>
<b>CHAPTER 4.....</b>		<b>169</b>
<b>FIRE RESISTANCE ASSESSMENT OF CONCRETE STRUCTURES ACCORDING TO EN 1992-1-2</b>		
<b>4.1</b>	<b>Motivation .....</b>	<b>171</b>
<b>4.2</b>	<b>Data concerning the studied building .....</b>	<b>172</b>
4.2.1	Description of the building.....	172
4.2.2	Mechanical material properties .....	174



4.2.2.1	General.....	174
4.2.2.2	Concrete.....	175
4.2.2.3	Reinforcing bars.....	176
4.2.3	Physical and thermal material properties .....	178
4.2.3.1	Thermal elongation of concrete and steel .....	178
4.2.3.2	Specific heat of concrete .....	179
4.2.3.3	Thermal conductivity of concrete .....	179
4.2.3.4	Concrete density.....	180
4.2.4	Description of reinforcing bars in members (column, beam and slab).....	180
4.2.4.1	Column B2.....	180
4.2.4.2	Beam in axis 2.....	181
4.2.4.3	Slab on beams .....	182
4.2.5	Actions .....	183
<b>4.3</b>	<b>Tabulated data .....</b>	<b>185</b>
4.3.1	Scope .....	185
4.3.2	Column 500/52.....	185
4.3.3	Beam 250/44.....	187
4.3.4	Slab 180/36/49.....	188
4.3.5	Conclusion.....	189
<b>4.4</b>	<b>Simplified calculation methods.....</b>	<b>190</b>
4.4.1	Methodology .....	190
4.4.2	Column .....	191
4.4.3	Beam.....	193
4.4.3.1	Calculation steps for bending resistance verification.....	193
4.4.3.2	Calculation steps for shear resistance verification .....	195
4.4.4	Two-way slab .....	197
<b>4.5</b>	<b>Advanced calculation methods .....</b>	<b>199</b>
4.5.1	Modelling description.....	199
4.5.2	Results .....	200
4.5.2.1	Column.....	200
4.5.2.2	Beam .....	200
4.5.2.3	Slab .....	201
4.5.2.4	Beam-slab-column assembly .....	202

<b>CHAPTER 5</b> .....	<b>205</b>
------------------------	------------

**FIRE RESISTANCE ASSESSMENT OF MASONRY STRUCTURES. OVERVIEW AND WORKED EXAMPLE**

<b>5.1 Introduction</b> .....	<b>206</b>
<b>5.2 Assessment methods in EN 1996-1-2</b> .....	<b>206</b>
5.2.1 Assessment by tests .....	206
5.2.2 Assessment by tabulated data.....	206
5.2.3 Assessment with calculation methods .....	207
<b>5.3 Worked example</b> .....	<b>208</b>
5.3.1 Design of the external wall.....	209
5.3.2 Design of the external column.....	210
5.3.3 Design of the internal non-separating wall.....	211
5.3.4 Design of the internal separating wall .....	212
<b>5.4 Conclusions</b> .....	<b>213</b>

<b>CHAPTER 6</b> .....	<b>215</b>
------------------------	------------

**FIRE RESISTANCE ASSESSMENT OF TIMBER STRUCTURES**

<b>6.1 Fire design of timber members</b> .....	<b>217</b>
6.1.1 Basis of design.....	217
6.1.2 Charring of timber .....	217
6.1.3 Simplified design method.....	219
6.1.4 Worked examples .....	220
6.1.4.1 Introduction.....	220
6.1.4.2 Fire design of the secondary unprotected timber beam for 30 minutes fire resistance.....	221
6.1.4.3 Fire design of the main unprotected timber beam for 30 minutes fire resistance .	222
6.1.4.4 Fire design of the unprotected timber column for 30 minutes fire resistance .....	223
6.1.4.5 Fire design of the protected timber column for 60 minutes fire resistance.....	225
6.1.4.6 Fire design of the unprotected timber column with increased cross-section for 60 min. fire resistance .....	227
<b>6.2 Fire design of timber connections</b> .....	<b>228</b>
6.2.1 Background .....	228
6.2.2 Worked examples .....	229

6.2.2.1	Introduction.....	229
6.2.2.2	Actions .....	230
6.2.2.3	Load-carrying capacity after a given fire exposure (strength verification).....	230
6.2.2.4	Fire resistance for a given load level (time verification) .....	231
6.2.2.5	Fire resistance of protected connection.....	231
<b>6.3</b>	<b>Fire design of separating timber assemblies.....</b>	<b>232</b>
6.3.1	Basis of design.....	232
6.3.2	Simplified design method.....	233
6.3.3	Worked example.....	235



## List of authors and editors

### Authors

#### CHAPTER 1 - EN 1991-1-2. Basic design methods and worked examples

Olivier VASSART                      ArcelorMittal Research & Development, Esch/Alzette,  
Grand-Duchy of Luxembourg

#### CHAPTER 2 - Fire resistance assessment of steel structures according to Part 1-2 of Eurocode 3 (EN 1993-1-2)

Bin ZHAO                                      CTICM, France

#### CHAPTER 3 - Eurocode 4: Design of composite steel and concrete structures. Part 1-2: General rules – Structural fire design

Louis-Guy CAJOT                      ArcelorMittal Research & Development, Esch/Alzette,  
Grand-Duchy of Luxembourg

#### CHAPTER 4 - Fire resistance assessment of concrete structures according to EN 1992-1-2

Fabienne ROBERT                      CERIB, France

#### CHAPTER 5 - Fire resistance assessment of masonry structures. Overview and worked example

Udo MEYER                                      Arbeitsgemeinschaft Mauerziegel, Germany

#### CHAPTER 6 - Fire resistance assessment of timber structures

Andrea FRANGI                              ETH Zurich, Institute of Structural Engineering,  
Switzerland

## Editors

Martin POLJANŠEK	European Commission, Joint Research Centre (JRC), Institute for the Protection and Security of the Citizen (IPSC), European Laboratory for Structural Assessment (ELSA), Via Enrico Fermi 2749, 21027 Ispra VA, Italy
Borislava NIKOLOVA	European Commission, Joint Research Centre (JRC), Institute for the Protection and Security of the Citizen (IPSC), European Laboratory for Structural Assessment (ELSA), Via Enrico Fermi 2749, 21027 Ispra VA, Italy
Luisa SOUSA	European Commission, Joint Research Centre (JRC), Institute for the Protection and Security of the Citizen (IPSC), European Laboratory for Structural Assessment (ELSA), Via Enrico Fermi 2749, 21027 Ispra VA, Italy
Silvia DIMOVA	European Commission, Joint Research Centre (JRC), Institute for the Protection and Security of the Citizen (IPSC), European Laboratory for Structural Assessment (ELSA), Via Enrico Fermi 2749, 21027 Ispra VA, Italy
Artur PINTO	European Commission, Joint Research Centre (JRC), Institute for the Protection and Security of the Citizen (IPSC), European Laboratory for Structural Assessment (ELSA), Via Enrico Fermi 2749, 21027 Ispra VA, Italy

## Foreword

The construction sector is of strategic importance to the EU as it delivers the buildings and infrastructure needed by the rest of the economy and society. It represents more than 10% of EU GDP and more than 50% of fixed capital formation. It is the largest single economic activity and it is the biggest industrial employer in Europe. The sector employs directly almost 20 million people. Construction is a key element not only for the implementation of the Single Market, but also for other construction relevant EU Policies, e.g. Sustainability, Environment and Energy, since 40-45% of Europe's energy consumption stems from buildings with a further 5-10% being used in processing and transport of construction products and components.

The EN Eurocodes are a set of European standards which provide common rules for the design of construction works, to check their strength and stability against live extreme loads such as fire and earthquakes. In line with the EU's strategy for smart, sustainable and inclusive growth (EU2020), standardization plays an important part in supporting the industrial policy for the globalization era. The improvement of the competition in EU markets through the adoption of the Eurocodes is recognized in the "Strategy for the sustainable competitiveness of the construction sector and its enterprises" – COM (2012)433, and they are distinguished as a tool for accelerating the process of convergence of different national and regional regulatory approaches.

With the publication of all the 58 Eurocodes Parts in 2007, the implementation of the Eurocodes is extending to all European countries and there are firm steps toward their adoption internationally. The Commission Recommendation of 11 December 2003 stresses the importance of training in the use of the Eurocodes, especially in engineering schools and as part of continuous professional development courses for engineers and technicians, which should be promoted both at national and international level. It is recommended to undertake research to facilitate the integration into the Eurocodes of the latest developments in scientific and technological knowledge.

In light of the Recommendation, DG JRC is collaborating with DG ENTR and CEN/TC250 "Structural Eurocodes" and is publishing the Report Series 'Support to the implementation, harmonization and further development of the Eurocodes' as JRC Scientific and Policy Reports. This Report Series includes, at present, the following types of reports:

1. Policy support documents – Resulting from the work of the JRC in cooperation with partners and stakeholders on 'Support to the implementation, promotion and further development of the Eurocodes and other standards for the building sector';
2. Technical documents – Facilitating the implementation and use of the Eurocodes and containing information and practical examples (Worked Examples) on the use of the Eurocodes and covering the design of structures or its parts (e.g. the technical reports containing the practical examples presented in the workshop on the Eurocodes with worked examples organized by the JRC);
3. Pre-normative documents – Resulting from the works of the CEN/TC250 and containing background information and/or first draft of proposed normative parts. These documents can be then converted to CEN technical specifications;
4. Background documents – Providing approved background information on current Eurocode part. The publication of the document is at the request of the relevant CEN/TC250 Sub-Committee;
5. Scientific/Technical information documents – Containing additional, non-contradictory information on current Eurocode part, which may facilitate its implementation and use, or preliminary results from pre-normative work and other studies, which may be used in future revisions and further developments of the standards. The authors are various stakeholders involved in Eurocodes process and the publication of these documents is authorized by relevant CEN/TC250 Sub-Committee or Working Group.

Editorial work for this Report Series is assured by the JRC together with partners and stakeholders, when appropriate. The publication of the reports type 3, 4 and 5 is made after approval for publication from the CEN/TC250 Co-ordination Group.

The publication of these reports by the JRC serves the purpose of implementation, further harmonization and development of the Eurocodes. However, it is noted that neither the Commission nor CEN are obliged to follow or endorse any recommendation or result included in these reports in the European legislation or standardization processes.

This report is part of the so-called Technical documents (Type 2 above) and contains a comprehensive description of the practical examples presented at the workshop “Structural Fire Design” with emphasis on worked examples. The workshop was held on 27-28 November 2012 in Brussels, Belgium and was organized by the Joint Research Centre of the European Commission together with CEN/TC250 Horizontal Group - Fire, with the support of CEN and the Member States. The workshop addressed representatives of public authorities, national standardisation bodies, research institutions, academia, industry and technical associations involved in training on the Eurocodes. The main objective was to facilitate training on fire resistance assessment of structures through the transfer of knowledge and training information from the Eurocodes – Structural Fire Design Parts writers (CEN/TC250 Horizontal Group - Fire) to key trainers at national level and Eurocodes users.

The workshop was a unique occasion to compile a state-of-the-art training kit comprising the slide presentations and technical papers with the worked examples, each focused on a specific structural material (i.e. steel, concrete, masonry, etc.). The present JRC Report compiles all the technical papers and the worked example prepared by the workshop lecturers. The editors and authors have sought to present useful and consistent information in this report. However, it must be noted that the report does not present complete design example and that the reader may still identify some discrepancies between chapters. The chapters presented in the report have been prepared by different authors therefore are partly reflecting the different practices in the EU Member States. Users of information contained in this report must satisfy themselves of its suitability for the purpose for which they intend to use it.

We would like to gratefully acknowledge the workshop lecturers and the members of CEN/TC250 Horizontal Group - Fire for their contribution in the organization of the workshop and development of the training material comprising the slide presentations and technical papers with the worked example.

All the material prepared for the workshop (slides presentations and JRC Report) is available to download from the “Eurocodes: Building the future” website (<http://eurocodes.jrc.ec.europa.eu>).

**M. Poljanšek, B. Nikolova, L.Sousa, S. Dimova, A. Pinto**

European Commission, Joint Research Centre (JRC),

Institute for the Protection and Security of the Citizen (IPSC),

European Laboratory for Structural Assessment (ELSA),

Via Enrico Fermi 2749, 21027 Ispra VA, Italy



## **CHAPTER 1**

### **EN 1991-1-2. BASIC DESIGN METHODS AND WORKED EXAMPLES**

**Olivier VASSART**

ArcelorMittal Research & Development, Esch/Alzette, Grand-Duchy of Luxembourg



## 1.1 Introduction

In the sixties, a number of dramatic fires, such as the fire at the supermarket “Innovation” in Brussels which left more than 300 dead and the fire at the discotheque 'Le cinq Sept' in Saint-Laurent-du-Pont in France led to a lot of new regulations everywhere in Europe.

Current regulations deal with a number of areas, including:

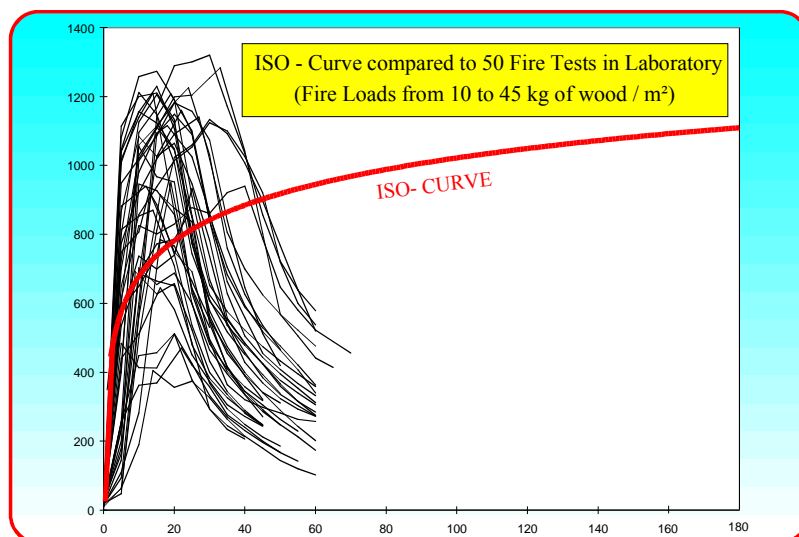
- Means of escape
- Fire spread: including, "fire resistance" and "reaction to fire"
- The fire resistance of the structure in terms of resistance periods - R30, 60, 90 or 120
- The smoke and heat exhaust ventilation system
- Active fire fighting measures such as hand extinguishers, smoke detectors, sprinklers
- Access for the Fire Brigade

Even if the general context and general notions of fire safety are the same everywhere in Europe, the requirements are non-uniform. This was analysed in the frame of the project NFSC1 [11] and has been updated thanks to data gathered during the recent ECSC project “Risk Based Fire Requirements” [18]. For example for a single storey building, the fire resistance required is up to R120 in Spain but no fire resistance is required in Switzerland [18]. For a medium rise office building a fire resistance R60 is required in the Netherlands compared to R120 in France [11]. The main parameters defining the requirements are the height of the building and the occupancy of the building related to the number of occupants and type of activities. Fire resistance requirements should be based on the parameters influencing fire growth and development. These include:

- Fire [probability of Fire occurrence, Fire spread, Fire duration, Fire load, Severity of fire...]
- Ventilation conditions
- Fire compartment (type, size, geometry)
- Type of the structural element
- Evacuation conditions
- Safety of the rescue teams
- Risk for the neighbouring buildings
- Active fire fighting measures

The current regulations do not take adequate account of the influence of sprinklers in suppressing or extinguishing the fire. The collected data in [11, 18] show that, except for very few cases, the present requirements are identical whether sprinklers are present or not. In order to consider all these physical factors in a systematic way, a more realistic and more credible approach to analyse structural safety in case of fire to include active fire fighting measures and real fire characteristics has been developed through different ECSC research projects and based on the “Natural Fire Safety Concept” [11, 12, 13, 18]. This methodology has been developed based on statistical, probabilistic and deterministic approaches and analysis. This method is applicable to all structural materials and buildings.

Figure 1.2.1 shows a comparison between the "natural" fire curves for different configurations (compartment size, fire loads, walls insulation, combustible characteristics, ...) and the standard ISO-Fire curve.



**Fig.1.2.1** Temperature-time curves from natural fire and from ISO-Fire

This shows the difficulties to understand the behaviour of elements in case of real fires using data obtained according to the single ISO-Fire curve. A real fire has characteristics that are not taken into account in the standard ISO-Fire curve. The characteristics of a real fire are shown in Figure 1.2.2 and include:

- A smouldering phase: ignition and smouldering fire at very low temperature with a duration that is often difficult to estimate. This phase is not shown in Figure 1.2.2.
- A growing phase called pre-flashover (localised fire): the duration of this phase depends mainly on the characteristics of the compartment. The fire remains localised up to a possible flashover.
- A flashover: the flashover is a generalised fire. This phase is generally very short.
- A post flashover fire: this phase corresponds to a generalised fire for which the duration depends on the fire load and the ventilation.
- A decreasing phase: the fire begins to decrease until all the combustible materials have completely burnt.

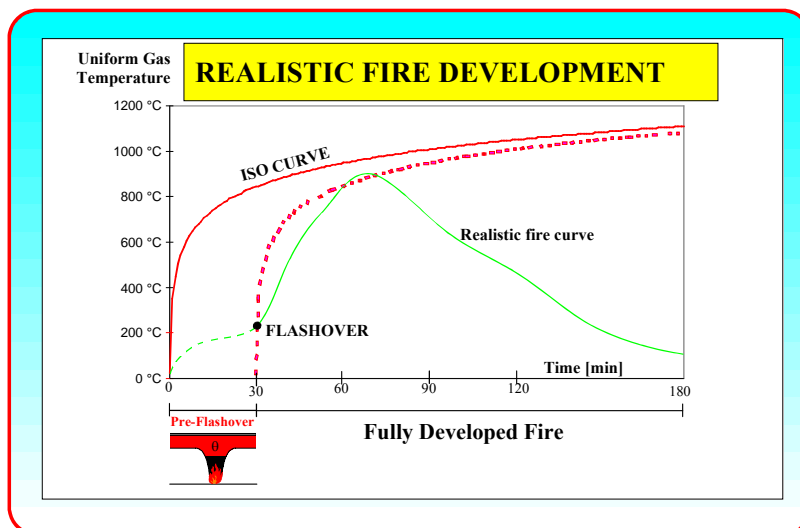


Fig.1.2.2 Natural fire phases

## 1.2 Methodology

### 1.2.1 Introduction

The determination of the fire development in a fire compartment requires knowledge of a large number of parameters. A number of these parameters are fixed by the characteristics of the building. Nevertheless, the main characteristic, the "fire load" is generally a function of the activity and may not be a constant during the life of the building. The fire load can be defined as a statistical distribution. For structural design at ambient temperature, the mechanical loads such as self-weight, imposed load and wind are also defined by a statistical distribution.

In the same way, the fire safety in a building has been determined through a probabilistic approach. In the global natural fire safety concept, the objective is defined by a target value of failure. The objective is not to change the safety level actually existing through the prescriptive codes but to quantify it through corresponding realistic failure probability or safety index. The combination of active and passive measures can be used to reach an acceptable level of safety.

The general method of safety quantification is based on the method used for structural design at ambient temperature and defines a design fire load taking into account the probability of fire occurrence and the influence of active fire fighting measures.

The design fire load is then used in the fire calculation models to assess the structural fire behaviour. Models to determine the temperature within the compartment are described here.

### 1.2.2 Objectives

The objective is to reach an acceptable safety level. This acceptable safety level can be defined by comparison to the other existing risks in life including the structural collapse of the building in normal

conditions. The target probability to have a structural collapse in normal conditions is  $7,23 \cdot 10^{-5}$  per building life [10]. The objective is:

$$P_f(\text{probability of failure}) \leq P_t (\text{target probability})$$

As it is defined in the Eurocodes, the fire is an accidental action. A large statistical study has been realised in order to determine the probability to have a fire occurrence. This ignition is a function of the activity of the building. A good correlation between statistics coming from different European countries has been found [11]. When the fire has started, a collapse can occur only if the fire reaches severe conditions. It is necessary to define the probability that the fire grows to a severe fire. In this phase, the active measures, the occupants and the firemen have an important role to play. It means that in a large number of cases, this fire will be stopped very quickly, and will never grow. According to statistics, the actions of active measures and fire brigade intervention considered in the building have been assessed to determine the probability to have a severe fire. So according to the active (sprinkler, detection, ...) and passive (compartmentation) measures used in the building, the activity in the building and the fire brigade intervention, a design fire load is calculated from the target probability. This procedure is presented and detailed in §1.5.

### 1.2.3 Fire development calculation method

Different levels of fire development calculation methods exist:

- simple models: mainly the parametric fires
- zone-models: these models take into account all the main parameters controlling the fire
- field models: too complex for use as a general design tool. However field models are the only tools valid for sophisticated geometry [19].

The assumptions of the one-zone model are related to a generalised fire with uniform temperature in the compartment while the two-zone models are related to a stratified smoke layer from a localised fire.

The main parameter of the fire development is the rate of heat release (RHR). This rate of heat release is a function of compartment size and activity and a function of time. The fire is initially a localised fire in the pre-flashover phase. The beginning of this phase is characterised by a fire growth that has been quantified according to a  $t^2$ -fire assumption. This means that the rate of heat release is defined by a parabolic equation. The buildings are classified into 4 categories according to the fire-spread velocity: low, medium, fast and ultra-fast. The rate of heat release will reach a maximum value corresponding to a steady state defined by fuel or ventilation control conditions.

One of the assessments is to know the RHR evolution and to define whether the fire will grow to a flashover or will remain a localised fire. When the conditions of flashover or generalised fire are not reached, a fire remains localised. In this condition, a two-zone model is used to estimate the general effect of the smoke layer. The local effect near the fire is also studied by empirical models developed in a previous research 'natural fire in large compartments' [8]. Hasemi [17] performed experimental investigations to determine the localised thermal actions from a fire, from which a simplified method was developed. The combination of both models allows the determination of the temperature field near and far away the fire.

#### **1.2.4 Structural fire behaviour**

According to this thermal action, thermal transfer to the structural elements has to be calculated. The models of different levels can be used. From the temperature field in the structure and from the combination of the mechanical loads in case of fire, the structural behaviour can be assessed with models also having different levels.

Simplified models using element/element calculations can be applied. Generally this model is based on the notion of critical temperature. If the heated temperature is below the critical temperature there is no failure and if the heated temperature is higher than the critical temperature there is failure. It is a 'pass or failure' criterion. The objective is then reached if the time to reach the failure is greater than the required natural fire exposure.

More sophisticated models, for example using finite element calculations, can be used. The results of the model are generally in terms of deformation during the whole fire duration. In some cases, the performance criteria (to measure at which level the objectives are fulfilled) can be given in terms of deformation.

Knowledge of the structural fire behaviour allows for an assessment against a range of performance criteria in terms of limited deformation or structural damage.

The choice of performance for design purposes will be dependent on the consequences of failure and the function of the building. For certain high-profile multi-storey buildings this may mean that no structural failure must take place during the whole duration of the fire.

#### **1.2.5 Required data**

In order to apply this methodology, the characteristics of the building have to be known. This methodology is applied compartment by compartment. The compartment has to be defined in terms not only of the geometry, but also thermal characteristics of the walls that are able to accumulate and to transfer a large part of the energy released by the fire, and the openings which allow the air exchange with the outside of the compartment. Some rules and tables are given in §1.3 in order to determine all these data.

### **1.3 Characteristics of the fire compartment**

#### **1.3.1 Introduction**

In the "Natural Fire Safety" approach, the fire safety design is based on physically determined thermal actions. In contrast with conventional design, parameters like the amount of fire load, the rate of heat release and the amount of ventilation play an important role in the natural fire design. In most buildings, the number of possible fire scenarios is infinite and need to be reduced. Only "credible worst case fire scenarios" are taken into account. If the design fire scenarios are chosen, a number of fire models are available to calculate thermal actions.

### 1.3.2 Boundary elements of the compartment

In the Natural Fire Safety Concept, the fire development is described in the fire compartment. The assumption is that the fire will not spread to other compartments. Whether this is true, depends on the fire behaviour of the boundary constructions (floors, wall [including doors], etc.).

It is necessary to understand this behaviour in order to assess their capability to function as fire barriers. The following options are available:

- Ad-hoc tests: the element can be exposed to a temperature-time curve in a furnace as calculated with fire models based on the worst-case fire scenarios.
- Expert judgement: this approach makes use of the available test-data of ISO-resistance tests on separating elements
- Direct use of ISO-requirements: national rules define fire compartments with ISO-fire resistance for walls, ceilings, doors and floors, depending on the use and the geometry of the building.

The first two options can be used for a limited number of separating elements, and will lead to high costs. In practice, often the 3<sup>rd</sup> option has to be used.

### 1.3.3 Wall: thermal characteristics

The heat loss from the compartment is an important factor for the temperature determination. Heat losses to the compartment boundaries occur by convection and radiation. Thermal properties of the walls have to be known.

The three main parameters characterising thermal properties of a material are:

- heat capacity  $c_p$
- density  $\rho$
- conductivity  $\lambda$

The conductivity and the heat capacity depend on temperature.

In simplified models, only thermal inertia, called b-factor, is used. The b-factor is determined from the thermal properties by the following equation:

$$b = \sqrt{\lambda \rho c_p}$$

For the calculation of the b factor, the density  $\rho$ , the specific heat capacity  $c_p$  and thermal conductivity  $\lambda$  of the boundary may be taken at ambient temperature [1].

In case of multi-material walls, it is suggested to deduce the b-factor from the following method:

- When a material (2) is insulated by a heavy material (1), so  $b_1 < b_2$ , the b-factor is the b-factor from the material 1:  $b = b_1$ .
- in the opposite, if  $b_1 > b_2$ , a limit thickness for the material 1 can be defined equal to:



$$s_{1,\text{lim}} = \sqrt{\frac{t_d \lambda_1}{c_1 \rho_1}}$$

where  $t_d$  is the time of the fire up to the decrease phase. Then the b-factor is determined by:

- if  $s_1 > s_{1,\text{lim}}$  then  $b = b_1$
- if  $s_1 < s_{1,\text{lim}}$  then  $b = \frac{s_1}{s_{1,\text{lim}}} b_1 + \left(1 - \frac{s_1}{s_{1,\text{lim}}}\right) b_2$

Table 1.3.1 gives the thermal characteristics of the most commonly used materials for different temperatures.

**Table 1.3.1** Thermal material characteristics

Material	Temperature [°C]	$\lambda$ [W/m/K]	$\rho$ [kg/m <sup>3</sup> ]	$c_p$ [J/kg°K]
Normal weight concrete	20	2	2300	900
	200	1,63	2300	1022
	500	1,21	2300	1164
	1000	0,83	2300	1289
Light weight concrete	20	1	1500	840
	200	0,875	1500	840
	500	0,6875	1500	840
	1000	0,5	1500	840
Steel	20	54	7850	425
	200	47	7850	530
	500	37	7850	667
	1000	27	7850	650
Gypsum insulating material	20	0,035	128	800
	200	0,06	128	900
	500	0,12	128	1050
	1000	0,27	128	1100
Sealing cement	20	0,0483	200	751
	250	0,0681	200	954
	500	0,1128	200	1052
	800	0,2016	200	1059
CaSi board	20	0,0685	450	748
	250	0,0786	450	956
	450	0,0951	450	1060
	1050	0,157	450	1440
Wood	20	0,1	450	1113
	250	0,1	450	1125
	450	0,1	450	1135

Material	Temperature [°C]	$\lambda$ [W/m/K]	$\rho$ [kg/m <sup>3</sup> ]	$c_p$ [J/kg°K]
Brick	1050	0,1	450	1164
	20	1,04	2000	1113
	200	1,04	2000	1125
	500	1,18	2000	1135
	1000	1,41	2000	1164
Glass	20	0,78	2700	840

### 1.3.4 Opening characteristics

Openings in an enclosure can consist of windows, doors and roof vents. The severity of the fire in an enclosure depends on the amount of openings in the enclosure.

Concerning the opening factor  $O$  used in simplified models, it is defined according the Eqn.(1.1) for a single vertical opening:

$$O = A_w \sqrt{H} \quad (1.1)$$

When several vertical openings have to be considered, the global area and an equivalent height have to be used. They are determined by Eqn.(1.2) and Eqn(1.3):

$$A_w = \sum A_{wi} \quad (1.2)$$

$$H = \left[ \frac{\sum A_{wi} \sqrt{H_i}}{\sum A_{wi}} \right]^2 \quad (1.3)$$

where  $A_w$  is the opening area,  $H$  the opening height and  $i$  is relative to the opening  $n^{\circ}i$ .

### 1.3.5 Mechanical ventilation

The use of pressurisation is an interesting way of protection for staircases.

The mechanical ventilation is also often used for Smoke and Heat Exhaust Ventilation System (SHEVS).

## 1.4 Characteristics of the fire

It is the aim of this section to provide all the information needed by a designer when he faces the fire design. The first data necessary to design a building against fire is to define the energy that is going to affect the structure. A way of knowing it would be to perform a real fire test in the building. This is uneconomic and besides would only provide information for one of the multiple fires that could happen in the building. Information from fire tests, existing models and fire dynamics have been combined so that a characterisation of the fire for different cases can be obtained.

## 1.4.1 Fire load

The first problem is to know which fire load to be considered in design. It is very rare that the fire load is known in a deterministic way. Generally it must be defined in a statistical way.

### 1.4.1.1 Deterministic approach

The fire load  $Q$  in a fire compartment is defined as the total energy able to be released in case of fire. Part of the total energy will be used to heat the compartment (walls and internal gas), the rest of the energy will be released through openings. Building components such as wall and ceiling linings, and building contents, such as furniture, constitute the fire load. Divided by the floor area, the fire load  $Q$  gives the fire load density  $q_f$ .

In EC 1, the characteristic fire load density is defined by the equation:

$$q_f = \frac{1}{A_f} \sum_i (\psi_i m_i H_{ui} M_i)$$

where:

- $M_i$  = the mass of the material  $i$  [kg]
- $H_{ui}$  = the net calorific value of the material  $i$  [MJ/kg] (see Table 1.4.1)
- $m_i$  = the factor describing the combustion behaviour of the material  $i$
- $\Psi_i$  = the factor of assessing protected fire load of the material  $i$
- $A_f$  = the floor area of the fire compartment [m<sup>2</sup>].

$H_{ui}M_i$  represents the total amount of energy contained in material  $i$  and released assuming a complete combustion. The 'm' factor is a non-dimensional factor between 0 and 1, representing the combustion efficiency:  $m = 1$  corresponds to complete combustion and  $m = 0$  to the case of materials that do not contribute to the fire at all.

A value of  $m = 0,8$  is suggested for standard materials. For wood, a value of 17,5 MJ/kg is suggested for  $H_u$  leading to 14 MJ/kg for ( $mH_u$ ).

**Table 1.4.1** Recommended net calorific value of combustible materials  $H_u$  [MJ/kg] for fire load calculation

<b>Solids</b>	
<b>Wood</b>	17,5
Other cellulosic materials	20
Clothes	
Cork	
Cotton	
Paper, cardboard	
Silk	
Straw	
Wool	

<b>Solids</b>	
Carbon	30
Anthracite	
Charcoal	
Coal	
<b>Chemicals</b>	
Paraffin series	50
Methane	
Ethane	
Propane	
Butane	
Olefin series	45
Ethylene	
Propylene	
Butene	
Aromatic series	40
Benzene	
Toluene	
Alcohols	30
Methanol	
Ethanol	
Ethyl alcohol	
Fuels	45
Gasoline, petroleum	
Diesel	
Pure hydrocarbons plastics	40
Polyethylene	
Polystyrene	
Polypropylene	
<b>Other products</b>	
ABS (plastic)	35
Polyester (plastic)	30
Polyisocyanerat and polyurethane (plastics)	25
Polyvinylchloride, PVC (plastic)	20
Bitumen, asphalt	40
Leather	20
Linoleum	20
Rubber tyre	30
<b>NOTE:</b> The values given in this table are not applicable for calculating energy content of fuels.	

### 1.4.1.2 Statistical approach

The fire load density can be estimated by summing all the fire loads present in a building: it is a deterministic approach. Some information is available on the fire load density for specific building types such as offices and schools. This statistical approach is only valid for building types where similar amounts of fire load can be expected. In those cases the fire load density can be given as a statistical distribution with a mean value and a standard deviation.

In the next table for a number of building types these values are given. The values are based on the Gumbel type I distribution. The values (for 80, 90 and 95% fractiles) are calculated using this distribution, assuming a variation coefficient of 0,3. These values of Table 1.4.2 are derived from a compendium of commonly accepted values extracted from international documents [2, 21, 22].

**Table 1.4.2** Data on fire load density for different buildings [MJ/m<sup>2</sup>] (Fitting with a Gumbel type I distribution)

	<b>Standard Deviation</b>	<b>Mean</b>	<b>80 % fractile</b>	<b>90 % fractile</b>	<b>95 % fractile</b>
Dwelling	234	780	948	1085	1217
Hospital	69	230	280	320	359
Hotel (room)	93	310	377	431	484
Library	450	1500	1824	2087	2340
Office (standard)	126	420	511	584	655
School	85,5	285	347	397	445
Shopping centre	180	600	730	835	936
Theatre (cinema)	90	300	365	417	468
Transport (public space)	30	100	122	139	156

### 1.4.2 Type of fire

Another question to be answered is what amount of the total fire load is going to burn in case of fire and how will this affect the temperature-time curve occurring in the scenario.

Fires never (except for arson or explosion, which are not in the scope of the research) start at the same time in a whole fire compartment. They always start as a localised fire that, depending on a series of conditions, will develop to a major fire.

Main differences between a localised and a fully developed fire are listed in Table 1.4.3.

**Table 1.4.3** Differences between localised and fully engulfed fires

<b>Fire load</b>		<b>Gas temperature</b>
Localised fire	Only a part of the compartment is in fire	Two zones (two temperature-time curves)
Fully developed fire	The fire load uniformly distributed in the whole compartment is in fire	One zone (one temperature-time curve)

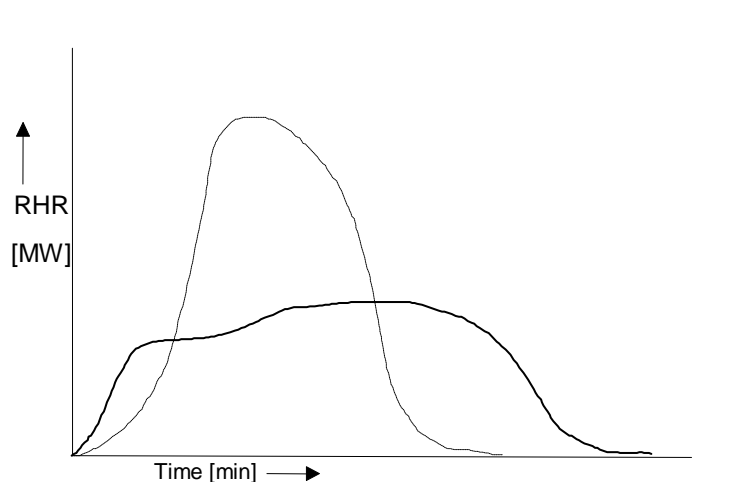
In situations in which the whole compartment is involved in the fire, a uniform gas temperature is assumed. In a fully developed fire all fire load is burning so that the whole compartment is filled with smoke, combustion products and air that mix so well that the gas in the whole compartment can be considered homogeneous and represented by a single temperature. A method that allows for determining the temperature-time curve(s) (T-t) to be used for the structural behaviour in case the fire is localised or fully developed is described in details in §1.6.

### 1.4.3 Design fire

Once the fire load has been characterised it must be known at which rate the fire load will burn. For this purpose the RHR shall be determined.

#### 1.4.3.1 Fuel control and ventilation control fires

The fire load defines the available energy but the gas temperature in a fire depends on the Rate of Heat Release. The same fire load burning very quickly or smouldering can lead to completely different gas temperature curves.



**Fig. 1.4.1** Two RHR curves corresponding to the same amount of fire load, as the surface beneath both curves is the same

The RHR is the source of the gas temperature rise, and the driving force behind the spreading of gas and smoke. A typical fire starts small and goes through a growth phase. Two things can then happen depending whether during the growth process there is always enough oxygen to sustain combustion.

Either, when the fire size reaches the maximum value without limitation of oxygen, the RHR is limited by the available fire load (fuel controlled fire).

Or if the size of openings in the compartment enclosure is too small to allow enough air to enter the compartment, the available oxygen limits the RHR and the fire is said to be ventilation controlled. Both ventilation and fuel-controlled fires can go through flashover.

This important phenomenon, flashover, marks the transition from a localized fire to a fire involving all the exposed combustible surfaces in the compartment. The two regimes are illustrated in Figure 1.4.2, which presents graphs of the rate of burning vs. the ventilation parameter  $A\sqrt{h}$ , with  $A$  being the

opening area and  $h$  being the opening height. Graphs are shown for different fire load densities. Starting on the left side of the figure in the ventilation controlled regime, with increasing ventilation parameter the rate of burning grows up to the limiting value determined by the fire load density and then remains approximately constant (fuel controlled region).

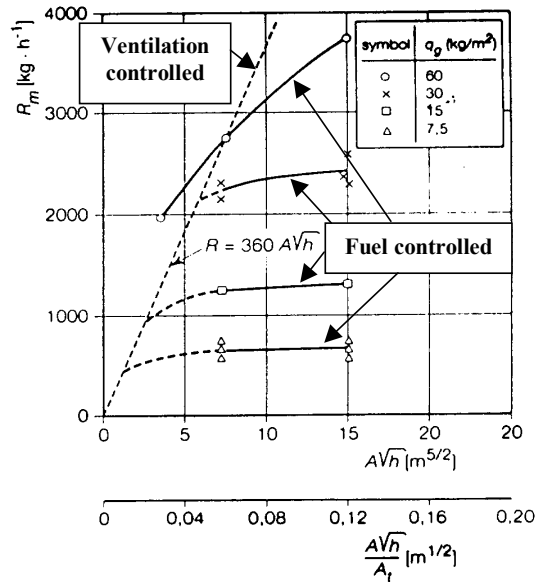


Fig.1.4.2 Mass rate for different fire load densities

### 1.4.3.2 Design RHR

The rise of the rate of heat release to the maximum value (see Figure 1.4.3) is given by the following equation:

$$RHR = (t / t_\alpha)^2$$

where:

- RHR = Rate of heat release of the fire during growth phase [MW]
- $t$  = time [s]
- $t_\alpha$  = time constant given in Figure 1.4.4 [s]

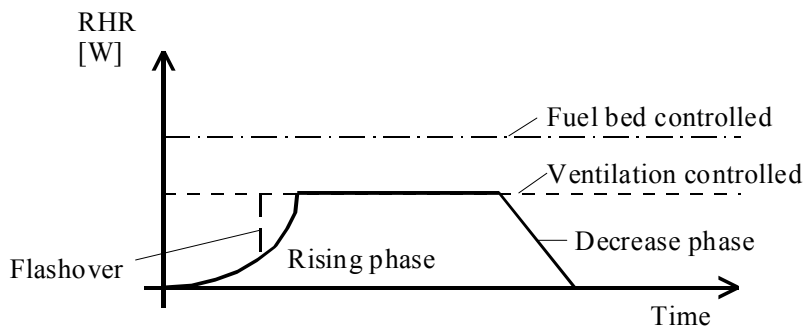


Fig.1.4.3 Rate of Heat Release in function of Time

Three phases are recognised, rise, stationary (post flashover) and decrease.

The fire growth parameter given in the code [1, 2] varies according to building types and some guidance towards the classification and determination of this parameter is shown in Figure 1.4.4.

After the growing phase, the RHR curve follows a horizontal plateau with a maximum value of RHR corresponding to fuel bed (see Figure 1.4.4) or ventilation controlled conditions.

In [1, 2] and [7] this decay phase is assumed to show a linear decrease of the RHR. Formulae are given to calculate the time of commencement of the decay period and the duration of the decay period. Based on test results, the decay phase can be estimated to start when approximately 70% of the total fire load has been consumed.

In the following Figure 1.4.4 the proposal for the RHR curve for the NFSC project is given. The curve includes the growing phase, steady state and the decay phase.

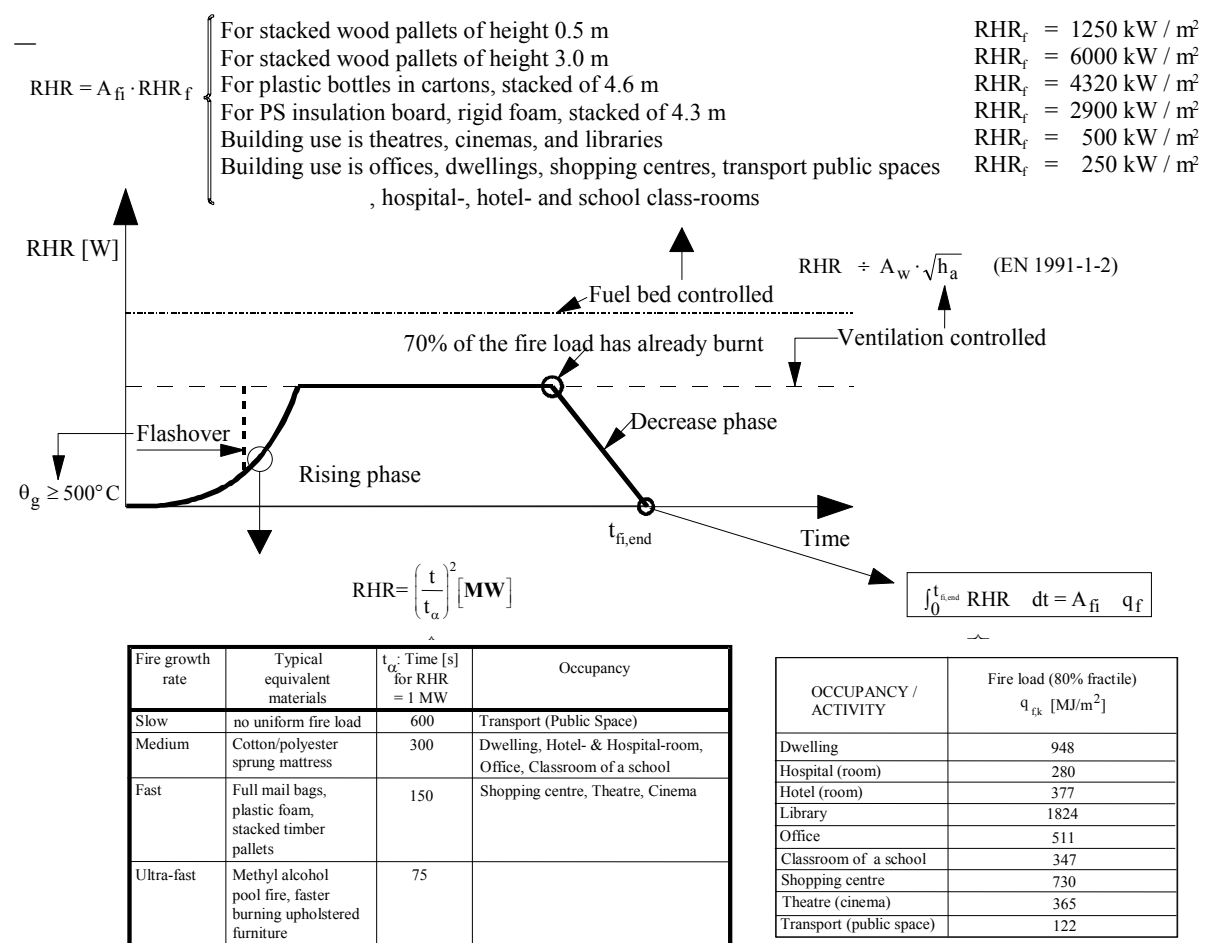


Fig.1.4.4 Design RHR curve [1]

### 1.4.3.3 Experimental data

Another way to obtain the RHR curve is to make a test. Techniques for measuring heat release rates (except in a calorific bomb) were not available until a few years ago, when the principle of oxygen depletion calorimetry was developed. Earlier attempts required the direct measurement of sensible enthalpy, which is very difficult to do correctly. The oxygen depletion technique, however, has



enabled these measurements to be made easily and with good accuracy. The oxygen consumption principle states that, within a small uncertainty band, the heat released from the combustion of any common combustible is uniquely related to the mass of oxygen removed from the combustion flow stream [6]. This technique has been used and database of test results established. Different sources are available in the literature to extract data for the value of RHR [3,4,5,6].

The Hazard [5] two-zone simulation model within its framework contains a database where various items are laid out and information on their RHR among other things is given. These items tend to be only items found in the home, such as chairs, TV's and Christmas trees. This obviously leads to a limitation in the field of use. Although in its particular region of use, it appears to be a very good source of information, since it includes every phase during a RHR curve. Argos [4] is another database found within the framework of a fire simulation programme. In Argos, different equations are given for solid material fires, melting material fires, liquid fire and smouldering fires. These equations define the RHR as a function of the fire spread velocity in the horizontal and vertical directions. The numerical values valid for different materials and objects are given in the Argos database.

Another source of test result information is the "Initial Fires" document compiled by the University of Lund [3]. This has the same format as the Hazard database but contains more results. In this document one can find information not only on household objects but also objects such as various vehicle types. CTICM in France has performed fire tests on new cars (fabricated in 1996) [9], on hotel rooms and on real furniture and measured the RHR. These experimental data are very interesting, because the majority of fire tests reported in the literature have been performed with wood cribs as fuel.

## **1.5 Probabilistic aspect**

### **1.5.1 Introduction**

The probability that a fire breaks out in a swimming pool is obviously much lower than in a painting workshop. The probability that this fire spreads and leads to a fully engulfed compartment depends on the compartment area and on the active fire fighting measures such as sprinklers, automatic fire detection by smoke or heat, automatic alarm transmission to fire brigade and fire brigade intervention.

Different ECSC research projects [11, 18] have enabled to gather statistics and to deduce the probability that:

- a fire starts
- the occupants fail to extinguish the fire
- the automatic active measures (sprinklers...) fail to extinguish the fire
- the fire brigade fail to extinguish the fire

The probability of successful intervention by the fire brigade depends mainly on the time to detect the fire (automatic fire detection by smoke or heat) and the time to reach the building (automatic transmission of the alarm and distance from fire brigade to building).

From those probabilities it is possible to deduce  $\gamma_{q,f}$  factor on the fire load by a procedure based on the Annex C of EN 1990 [10] and reliability calculations. This procedure is summarised in §1.5.4.

This factor  $\gamma_{qf}$  has been divided into sub-coefficients  $\delta_{q1}$ ,  $\delta_{q2}$ ,  $\delta_{ni}$  to take into account the compartment size, the building type and the different active fire fighting measures. The characteristic fire load  $q_{f,k}$  has to be multiplied by  $\gamma_{qf} = \delta_{q1}\delta_{q2}\delta_{ni}$  to obtain the design fire load  $q_{f,d}$ .

The design fire load,  $q_{f,d}$  is then used by the “Natural Fire Models” tools (see following §1.6) to calculate the design natural fire heating.

## 1.5.2 Statistics

This statistical study has been based on data [11] from

- Switzerland: detailed information and analysis of all fires ( $\pm 40\,000$  fires) causing damage larger than 1.000.000 CHF in Bern from 1986 to 1995.
- France: fires in industrial buildings occurring between January 1983 to February 1984, all fire brigade intervention in 1995 (3 253 855 interventions of which 312 910 were for fires).
- The Netherlands: fires in industrial buildings occurring between January 1983 and January 1985.
- Finland: all the building fires in 95 (2 109 fires for a total number of buildings of 1 150 494).

In the scope of [18] additional results for Finland, based on combining the information in the national fire statistics database “PRONTO” of the Ministry of Interior and other relevant national statistical database, have been added for the year 1996-1999.

The Luxembourg fire brigade reports for 1995 and 1997 and international data from different sources on various aspects of fire safety namely sprinkler performance. Database on the effects of sprinklers were summarised or collected from USA, Finland, Germany, France, Australia and UK [13].

The following statistics concern mainly dwellings, offices and industrial buildings and have been adopted for developing the procedure. This procedure has been extended to other activities by the coefficient  $\delta_{q1}$  given in Table 1.5.6.

## 1.5.3 Probabilities

### 1.5.3.1 Event tree analysis

An event tree (see Figure 1.5.1) may be established from fire start to describe fire growth, using recommended default values from Table 1.5.1.

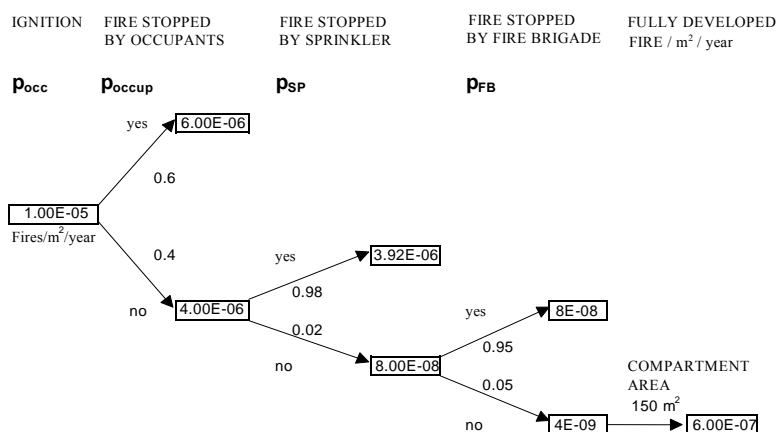


Fig.1.5.1 Example for an event tree for fire growth in an office with a compartment area of 150 m<sup>2</sup>

Table 1.5.1 Event tree factors

		Dwelling	Office	Industrial
Fire occurrence [1/(m <sup>2</sup> .year)]	p <sub>occ</sub>	30 · 10 <sup>-6</sup>	10 · 10 <sup>-6</sup>	10 · 10 <sup>-6</sup>
Fire stopped by occupant	p <sub>occup</sub>	0,75	0,60	0,45
Fire stopped by sprinkler system	p <sub>SP</sub>	see Table 1.5.5		
Fire stopped by standard fire brigade	p <sub>FB</sub>	0,90 - 0,95	0,90 - 0,95	0,80 - 0,90

### 1.5.3.2 Fire occurrence and fire growth

The probability of a severe fire per year able to endanger the structural stability may be expressed as:

$$P_{fi} = p_1 p_2 p_3 p_4 A_{fi}$$

with

- p<sub>1</sub> probability of severe fire including the effect of occupants and standard public fire brigade (per m<sup>2</sup> of floor and per year)
- p<sub>2</sub> additional reduction factor depending on the fire brigade types and on the time between alarm and firemen intervention
- p<sub>3</sub> reduction factor if automatic fire detection (by smoke or heat) and / or automatic transmission of the alarm are present
- p<sub>4</sub> reduction factor if sprinkler system is present (p<sub>4</sub> is also the probability of failure of sprinkler in stopping the fire)
- A<sub>fi</sub> surface area of the fire compartment

Note: The factor p<sub>1</sub> includes the actions of the occupants and the public fire brigade in preventing a fire to grow into a severe fire and is not to be mistaken as the frequency of fire occurrence.

The influence of fire brigade types, time between alarm and firemen intervention, automatic detection and automatic alarm transmission ( $p_2$ ,  $p_3$ ) has not been considered in the Table 1.5.1,  $p_1$  of Table 1.5.2 is in fact  $p_{occ}(1-p_{occup})(1-p_{FB})$ .

According [11, 18], the following values are recommended for  $p_1$ ,  $p_2$ ,  $p_3$  and  $p_4$ .

**Table 1.5.2** Frequency of fire start and growth to severe fire including standard public fire brigade

Occupancy/Activity	$p_1$ [ $10^{-7}/(m^2 \text{ year})$ ]
Office	2 – 4
Dwelling	4 – 9
Industrial	5 – 10

**Table 1.5.3** Additional reduction factor depending on the fire brigade type and on the time between alarm and firemen intervention

$p_2$	Time between Alarm and Action of the FIREMEN		
	$\leq 10'$	$10' < t \leq 20'$	$20' < t \leq 30'$
Type of FIREMEN			
Professional	0,05	0,1	0,2
Not-Professional	0,1	0,2	1

**Table 1.5.4** Reduction factor for automatic fire detection (by smoke or heat) and automatic transmission of the alarm

Active Measures	$p_3$
Detection by smoke	0,0625
Detection by Heat	0,25
Automatic Alarm transmission to Fire Brigade	0,25

**Table 1.5.5** Reduction factor for sprinkler system

Type of sprinkler	$p_4$
Normal (e.g. according to the regulations)	0,02
High standard (e.g. electronically checked valve, two independent water sources)	0,01 - 0,005
Low standard (e.g. not according to the regulations)	$\geq 0,05$

## 1.5.4 Procedure

### 1.5.4.1 Determination of the design values of actions and resistances - Safety factor $\gamma$ in the Eurocodes - Principle for normal conditions of use

The resistance  $R$  and the action  $S$  are according to statistical distributions, which are defined by the standard deviations ( $\sigma_S, \sigma_R$ ) and the means ( $m_S, m_R$ ). To ensure a sufficient safety, it is necessary that

the failure ( $S > R$ ) occurs only with a very low probability  $p_f$  represented given by the hatched area (see Figure 1.5.2). This area can be measured by the safety index  $\beta$ .

The Eurocodes in normal conditions require a maximum failure probability  $p_t$  of  $7,23 \cdot 10^{-5}$  for the building life, which corresponds to a safety index  $\beta_t$  of 3,8.

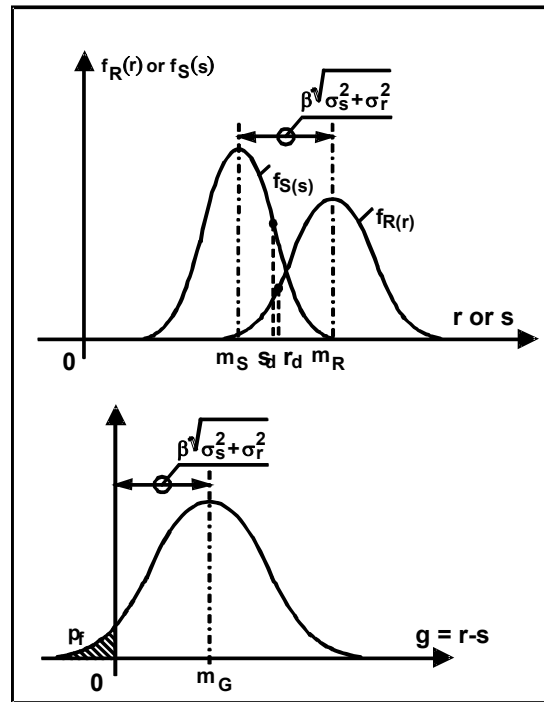


Fig.1.5.2 Probabilistic approach

$$p_f \leq p_t (= 7,23 \cdot 10^{-5}) \rightarrow \beta > \beta_t (= 3,8)$$

$$m_R - m_S \geq \beta \sqrt{\sigma_S^2 - \sigma_R^2} = \beta \frac{\sigma_S^2 - \sigma_R^2}{\sqrt{\sigma_S^2 - \sigma_R^2}}$$

$$\Rightarrow \overbrace{m_R - \frac{\sigma_R}{\sqrt{\sigma_S^2 - \sigma_R^2}} \beta \sigma_R}^{r_d} \geq \overbrace{m_S - \frac{\sigma_S}{\sqrt{\sigma_S^2 - \sigma_R^2}} \beta \sigma_S}^{s_d}$$

$$\Rightarrow r_d \geq s_d$$

For the two variables S and R, corresponding to action and resistance, the design values are given by  $s_d$  and  $r_d$ , respectively.

However, there are a lot of actions: (self-weight, variable load, snow, wind, earthquake, fire...) and a lot of resistances (compressive strength of concrete, yield point of the steel of the profiles, of rebars,...).

Therefore the problem is much more complex than the comparison between two statistical variables. That's why the Eurocodes have adopted a semi-probabilistic approach based on the FORM method (First Order Reliability Method).

This simplification of the Eurocodes consists of assuming:

$$\alpha_R = \frac{\sigma_R}{\sqrt{\sigma_R^2 + \sigma_S^2}} = 0,8 \text{ for the resistance.}$$

$$\alpha_S = \frac{\sigma_S}{\sqrt{\sigma_R^2 + \sigma_S^2}} = (-0,7) \text{ for the main action and } (-0,28) \text{ for the secondary action}$$

$$\Rightarrow s_{d,i} = \text{Design Value} = m_{S,i} + 0,7\beta\sigma_{S,i}$$

$$\Rightarrow r_{d,i} = \text{Design Value} = m_{R,i} - 0,8\beta\sigma_{R,i}$$

By considering constant values for the weighing factors  $\alpha_{s,i}$ , the design values  $s_{d,i}$  for actions can be defined without referring to the resistance, as these design values depend only on the safety index  $\beta$ , on the mean and the standard deviation of the corresponding statistical distribution and, of course, on the type of the distribution (see Figure 1.5.2 [10]).

These design values  $s_{d,i}$  of the actions are thus the values of the actions which have to be considered in order to obtain the required safety. If  $\beta$  is equal to 3,8 as in the Eurocodes, this implies that the failure risk is equal to  $7,23 \cdot 10^{-5}$  during the building life.

As a consequence, for each action, it is possible to define safety coefficient  $\gamma$ , which is the ratio between the design value  $s_d$  and the characteristic value, which is the usual reference value:

$$\gamma = \frac{S_d}{S_k}$$

In this way can be found the safety coefficients given in the Eurocodes: on the action side 1,35 and 1,5 for the self-weight and the imposed loads; on the resistance side 1,0, 1,15 and 1,5 for structural steel, reinforcement bars and concrete, respectively [1, 16, 20, 24].

Hereafter the calculation of the  $\gamma_s$  of 1,15 for the rebars is given as an example [20]:

$$\beta = 3,8; \quad a_a = 0,8$$

Statistical law: Lognormal

Variation coefficients  $\left( = \frac{\sigma}{m} \right)$ :

$$V_R = \sqrt{V_G^2 + V_m^2 + V_f^2} = 0,087 \quad \text{variation coefficient for the design value}$$

$$V_G = 0,05 \quad \text{variation coefficient for geometry of element}$$

$$V_m = 0,05 \quad \text{variation coefficient for model uncertainty}$$

$$V_f = 0,05 \quad \text{variation coefficient or mechanical property}$$

Design value:

$$X_d = m_X \exp(-\alpha_R \beta V_R) = m_X \exp(-0,8\beta V_R)$$

Characteristic value:

$$X_k = m_x \exp(-kV_f) \text{ with } k = 1,645 \text{ corresponding to the 5 \% fractile.}$$

Safety Factor:

$$\gamma_s = \frac{X_k}{X_d} = \exp(0,8\beta V_R - kV_f) = \exp(0,8 \cdot 3,8 \cdot 0,087 - 1,645 \cdot 0,05) = 1,198.$$

#### 1.5.4.2 Target value

The assumption of a target failure probability  $p_t$  of  $7,23 \cdot 10^{-5}$  per building life ( $1,3 \cdot 10^{-6}$  per year) is defined in EN 1990 [10]. That safety requirement ( $\beta > 3,8$ ) for ultimate limit state in normal conditions has also been adopted as the acceptance criteria for the structural fire resistance. In fact, the required safety in case of fire could be differentiated. This idea has been developed in the final report of [11] (§2.8 of the Annex B of the Working Group 5 part), where it is proposed to use a target failure probability  $p_t$  [1/year] depending on the people evacuation:

$$\begin{aligned} p_t &= 1,3 \cdot 10^{-4} && \text{for normal evacuation } p_t \text{ [1/year]} \\ p_t &= 1,3 \cdot 10^{-5} && \text{for difficult evacuation (hospitals, etc.)} \\ p_t &= 1,3 \cdot 10^{-6} && \text{for no possible evacuation (e.g. high rise building).} \end{aligned}$$

It might lead to future interesting improvements but it was decided to keep the value of EN 1990 [10] accepted by everybody whereas discussions should be needed to convince the Authorities to adopt lower new target values.

#### 1.5.4.3 Fire design and conditional probability

The Annex C of EN 1990 [10], which describes the semi-probabilistic concept leading to the design values for the actions and for the material properties, has been extended to the structural fire resistance.

At room temperature, the safety factors for the actions  $\gamma_{S,i}$  and the material properties  $\gamma_{R,i}$  have been deduced by a semi-probabilistic approach which assumes implicitly that the failure probability of the structure  $p_f$  is lower than a target failure probability  $p_t$  of  $7,23 \cdot 10^{-5}$  per working life of the building, which is equivalent to a safety factor  $\beta$  of 3,8:

$$p_f \text{ (failure probability)} \leq p_t \text{ (target probability)} \quad (1.4)$$

In case of fire, the main action is the fire, which can be quantified by the fire load expressed in kg of wood or in MJ. However, this fire load becomes a real action for the structure only when there is a fire.

The fire load influences the structure only with a certain probability  $p_{fi}$ ,  $p_{fi}$  being the product of  $p_{start}$  (probability that a fire starts) and  $p_{spread}$  (probability that this starting fire turns to a flash-over or a fully engulfed fire compartment).

In case of fire which is considered as an accidental action the Eqn.(1.4) becomes:

$$p_{f,fi} \text{ (failure probability in case of fire)} \cdot p_{fi} \text{ (probability of fire)} \leq p_t \text{ (target probability).}$$

which can be written:

$$p_{f,fi} \leq (p_t / p_{fi})$$

$$p_{f,fi} \leq p_{t,fi} \quad \Rightarrow \quad \beta_{f,fi} \geq \beta_{fi,t} \quad (1.5)$$

Whereas the target value  $p_t$  of  $7,23 \cdot 10^{-5}$  leads to the constant safety index  $\beta_t$  at room temperature, there is not in case of fire a fixed value of the safety index (called  $\beta_{fi,t}$  in case of fire) because the target value  $p_{t,fi}$  depends through Eqn.(1.5) of the probability of fire  $p_{fi}$ . Knowing  $\beta_{fi,t}$ , the design value of the fire load can be deduced as explained hereafter.

#### 1.5.4.4 Design fire load and $\delta$ factor

Reliability calculations (see § 7.4 of [11]) have showed that the weighing factor for the main action at room temperature is strongly reduced in case of fire and may therefore be considered as a secondary action whereas the fire load becomes the main action.

Moreover these calculations have pointed out that the assumption of the weighing factor of (-0,7) for the main action has to be modified and that a value of (-0,9) should be chosen for  $\alpha_{qf}$ .

According to the fire load densities given in the UK document “The Application of Fire Safety Engineering Principles to the Safety in Buildings” [14] and Prof. Fontana’s analysis [15], the data of fire loads fit well into a Gumbel type I distribution. A variation coefficient  $V_{qf}$  of 0,3 has been chosen [11].

According to [10], the design value (see variable loads) for the Gumbel distribution is given by:

$$q_{f,d} = m_{qf} \left\{ 1 - \frac{\sqrt{6}}{\pi} V_{qf} \left[ 0,577 + \ln \left( -\ln \varphi \left( 0,9 \beta_{fi,t} \right) \right) \right] \right\}$$

with  $m_{qf}$  the mean value of the fire load and  $\phi$  the distribution function of the normal distribution.

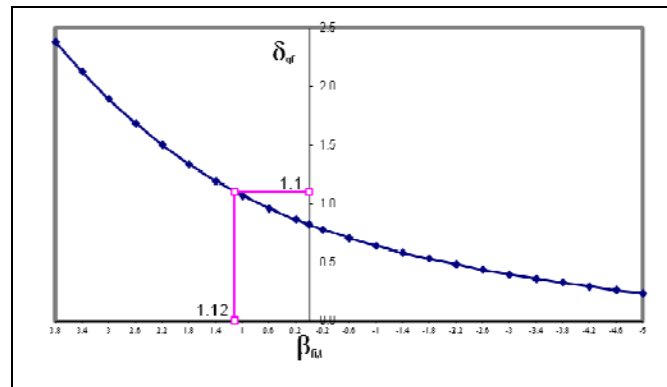
As proposed in [16], a safety factor for the model for calculating the action effect  $\gamma_{sD} = 1,05$  has been considered.

By choosing a characteristic value  $q_{f,k}$  of 80 % fractile (see Annex E of EN 1991-1-2 [1] and [11]), the factor  $\delta_{qf}$  becomes:

$$\delta_{qf} = \frac{q_{f,d}}{q_{f,k}} = 1,05 \frac{\left\{ 1 - \frac{\sqrt{6}}{\pi} V_{qf} \left[ 0,577 + \ln \left( -\ln \varphi \left( 0,9 \beta_{fi,t} \right) \right) \right] \right\}}{\left\{ 1 - \frac{\sqrt{6}}{\pi} V_{qf} \left[ 0,577 + \ln \left( -\ln 0,8 \right) \right] \right\}} = \begin{cases} 2,38 & \text{for } \beta = 3,8 \\ 0,82 & \text{for } \beta = 0 \end{cases}$$

The evolution of  $\delta_{qf}$  as a function of  $\beta_{fi,t}$  is given on Figure 1.5.3.





**Fig.1.5.3** Safety factor  $\delta_{qf}$  as a function of  $\beta_{fi}$

The safety index  $\beta_{fi,t}$  can be calculated from the probability of severe fire  $p_{fi}$  by the following formula:

$$\beta_{fi,t} = \phi^{-1} \left( \frac{p_t}{p_{fi}} \right) = \phi^{-1} \left( \frac{7,23 \cdot 10^{-5}}{p_{fi}} \right)$$

where  $\phi^{-1}$  is the inverse of the cumulative Standard Normal Distribution.

Figure 1.5.3 enables then deducing the  $\delta_{qf}$  factor for the fire load.

This global procedure implies:

- to determine the probability to have a severe fire  $p_{fi}$
- to calculate  $(p_t/p_{fi})$
- to deduce the target reliability index  $\beta_{fi,t}$
- to obtain the factor  $\delta_{qf}$ .

This approach has been differentiated by splitting the factor  $\delta_{qf}$  into 3 coefficients  $\delta_{q1}$ ,  $\delta_{q2}$  and  $\delta_{ni}$  to consider the influence on  $p_{fi}$  of the compartment size, the risk of fire activation and the active fire fighting measures, respectively (see Table 1.5.6).

**Table 1.5.6** Resuming table of  $\delta$  factors [1]

Compartment floor area $A_f$ [m <sup>2</sup> ]	Danger of Fire Activation $\delta_{q1}$	Danger of Fire Activation $\delta_{q2}$	Examples of Occupancies
25	1,10	0,78	artgallery, museum, swimming pool
250	1,50	1,00	residence, hotel, office
2500	1,90	1,22	manufactory for machinery & engines
5000	2,00	1,44	Chemical laboratory Painting workshop
10000	2,13	1,66	Manufactory of fireworks or paints

$\delta_{ni}$ Function of Active Fire Safety Measures									
Automatic Fire Suppression		Automatic Fire Detection			Manual Fire Suppression				
Automatic Water Extinguishing System $\delta_{n1}$	Independent Water Supplies $\delta_{n2}$	Automatic fire Detection & Alarm by Heat $\delta_{n3}$	Automatic Alarm Transmission to Fire Brigade by Smoke $\delta_{n4}$	Fire Brigade $\delta_{n5}$	Work Fire Brigade $\delta_{n6}$	Off Site Fire Brigade $\delta_{n7}$	Safe Access Routes $\delta_{n8}$	Fire Fighting Devices $\delta_{n9}$	Smoke Exhaust System $\delta_{n10}$
0,61	1,0   0,87   0,7	0,87 or 0,73	0,87		0,61 or 0,78		0,9 or 1   1,5*	1,0   1,5*	1,0   1,5*

\* For normal fire fighting measures, which should be almost always present, such as the Safe Access the Fire Fighting Devices and the Smoke Exhaust System in staircases, the  $\delta_{ni}$  should be taken as 1,5 in case those measures either are unsatisfactory either are not

When the factors  $\delta_{q1}$ ,  $\delta_{q2}$  and  $\delta_{ni}$  are determined, the design fire load  $q_{f,d}$  can be deduced:

$$q_{f,d} = \delta_{q1} \delta_{q2} \delta_{ni} q_{f,k}$$

The design fire load is then used by the tools presented in §1.6.

## **1.6 Fire development calculations**

### **1.6.1 Introduction**

When simulating numerically the fire development, different simplifications of the fire dynamics can be made. The present chapter will explain the models to apply in pre-flashover situation (the models of localised fire and two-zone models) and in post-flashover situation (fully-engulfed fire). The field Models (CFD: Computer Fluid Dynamics) are excluded in this chapter. They are too complex and time consuming to be used as a simple tool.

### **1.6.2 Localised fire**

In a localised fire, there is an accumulation of combustion products in a layer beneath the ceiling (upper layer), with a horizontal interface between this hot layer and the lower layer where the temperature of the gases remains much colder.

This situation is well represented by a two-zone model, useful for all pre-flashover conditions. Besides calculating the evolution of gas temperature, these models are used in order to know the smoke propagation in buildings and to estimate the life safety as a function of smoke layer height, toxic gases concentration, radiative flux and optical density.

The thermal action on horizontal elements located above the fire also depends on their distance from the fire. It can be assessed by specific models for the evaluation of the local effect on adjacent elements, such as Heskestad's or Hasemi's method [17].

#### **1.6.2.1 Two-zone models**

Zone model is the name given to numerical programs which calculate the development of the temperature of the gases as a function of time, integrating the ordinary differential equations which express the conservation of mass and the conservation of energy for each zone of the compartment. They are based on the fundamental hypothesis that the temperature is uniform in each zone.

Zone models give not only the evolution of the temperature of the gases in the compartment, but also additional information such as the temperatures in the walls or the velocity of the gases through the openings.

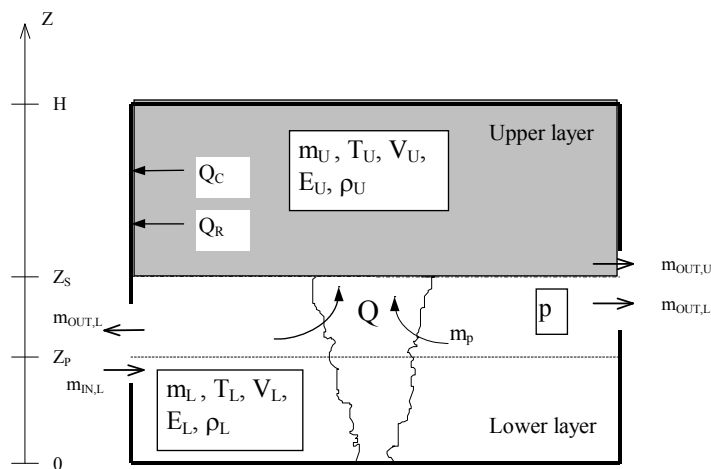
The data which have to be provided to a zone model are:

- geometrical data, such as the dimensions of the compartment, the openings and the partitions;
- material properties of the walls;

- fire data, as RHR curve, pyrolysis rate, combustion heat of fuel.

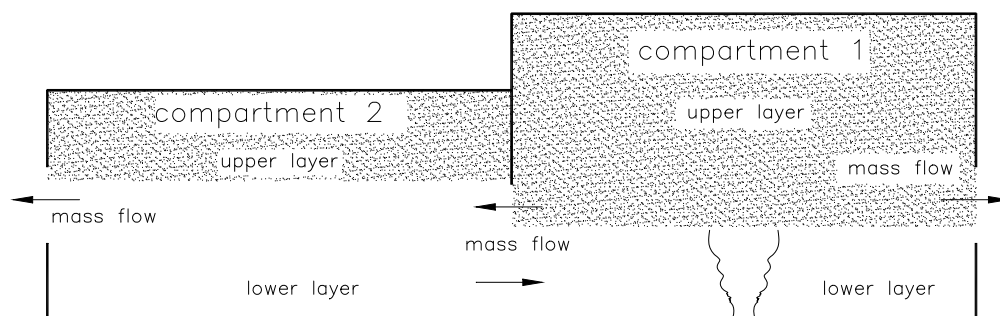
In a two-zone model the equations expressing the equilibrium of mass and of energy are written for each of the two layers and exchanges between the two layers are considered through air entrainment models.

As a result of the simulation, the gas temperature is given in each of the two layers, as well as information on wall temperatures and flux through the openings. An important result is the evolution, as a function of time, of the thickness of each layer. The thickness of the lower layer, which remains at rather cold temperature and contains no combustion products, is very important to assess the tenability of the compartment for the occupants. Figure 1.6.1 shows how a compartment is modelled by a two-zone model, with different terms of the energy and mass balance represented.



**Fig.1.6.1** A compartment in a two-zone model

Figure 1.6.1 is typical of a simple situation where the compartment exchanges mass and energy only with the outside environment. This kind of models has the capability to analyse more complex buildings where the compartment of origin exchanges mass and energy with the outside environment but also with other compartments in the building. This is of particular interest to analyse the propagation of smoke from the compartment of origin towards other adjacent compartments. Such a situation, analysed by multi-compartment two-zone models, is depicted on Figure 1.6.2.



**Fig.1.6.2** A compartment in a multi-compartment two-zone model

### 1.6.2.2 The Heskestad method

Thermal action of a localised fire can be assessed by using the Heskestad method [1]. Differences have to be made regarding the relative height of the flame to the ceiling.

The flame lengths  $L_f$  of a localised fire (see Figure 1.6.3) is given by:

$$L_f = -1,02D + 0,0148Q^{2/5}$$

When the flame is not impacting the ceiling of a compartment ( $L_f < H$ ; see Figure 1.6.3) or in case of fire in open air, the temperature  $\Theta_{(z)}$  in the plume along the symmetrical vertical flame axis is given by:

$$\Theta_{(z)} = 20 + 0,25 Q_c^{2/5} (z - z_0)^{-5/3}$$

where

- D is the diameter of the fire [m], see Figure 1.6.3
- Q is the rate of heat release [W] of the fire
- $Q_c$  is the convective part of the rate of heat release [W], with  $Q_c = 0,8Q$  by default
- Z is the height [m] along the flame axis, see Figure 1.6.3
- H is the distance [m] between the fire source and the ceiling, see Figure 1.6.3

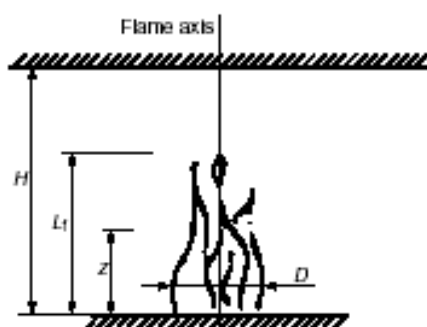


Fig.1.6.3 Localised fire model for flames not impacting the ceiling

### 1.6.2.3 Hasemi's method

Hasemi's method [1, 17] is a simple tool for the evaluation of the localised effect on horizontal elements located above the fire. It is based on the results of tests made at the Building Research Institute in Tsukuba, Japan.

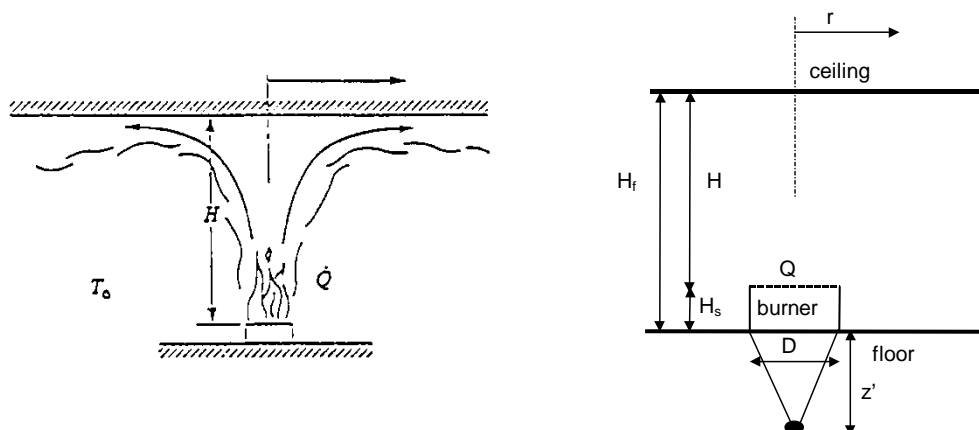


Fig.1.6.4 Localised fire scheme and Hasemi fire description

The data for the application of the method are:

- Q Rate of the Heat Release of the fire [W]
- $H_f$  height between floor and ceiling [m]
- D diameter (or characteristic length) of the fire [m]
- $H_s$  vertical distance between the floor and the seat of the fire source [m].

The variables are:

- H distance between the fire source and the ceiling [m]
- $Q^*$  non-dimensional Rate of Heat Release [-]
- $Q_H^*$  non-dimensional Rate of Heat Release [-]
- $z'$  vertical position of the virtual heat source, with respect to the seat of the fire source [m]
- $L_H$  horizontal length of the flame on the ceiling [m]
- r horizontal distance, at the ceiling, from the centre of the fire [m].

The procedure is:

- Calculate H

$$H = H_f - H_s$$

- Calculate  $Q^*$

$$Q^* = \frac{Q}{1,11 \cdot 10^6 \cdot D^{2,5}}$$

- Calculate  $Q_H^*$

$$Q_H^* = \frac{Q}{1,11 \cdot 10^6 \cdot H^{2,5}}$$

- Calculate  $z'$

$$z' = 2,4D(Q^{*2/5} - Q^{*2/3}) \quad Q^* < 1,00$$

$$z' = 2,4D(1,00 - Q^{*2/5}) \quad Q^* \geq 1,00$$

- Calculate  $(L_H + H)/H$

$$\frac{L_H + H}{H} = 2,90 Q_H^{*0,33}$$

- Calculate  $L_H$  from the value calculated in the previous equation and from the value of H.
- Calculate the value of the flux  $q''$  in  $[\text{kW/m}^2]$  at a distance  $r$ , according to

$$q'' = 100 \quad y < 0,30$$

$$q'' = 136,30 - 121,00y \quad 0,30 < y < 1,0$$

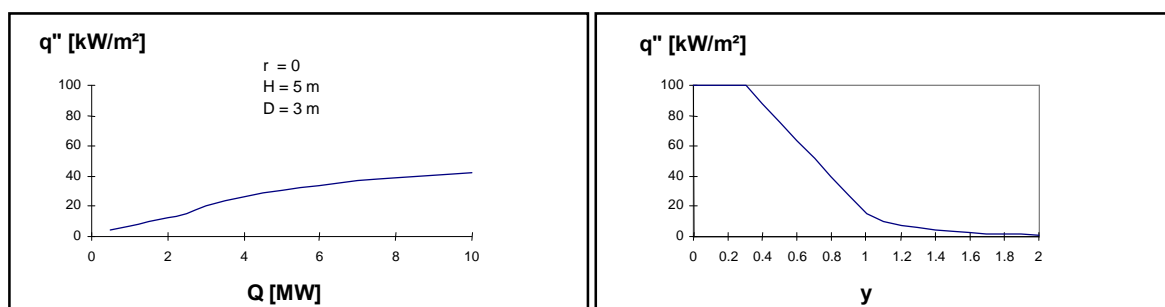
$$q'' = 135y^{-3,7} \quad y > 1,0$$

where

$$y = \frac{r + H + z'}{L_H + H + z'}$$

The flux  $q''$  received by the ceiling decreases as a function of the ratio  $y$  and increases as a function of  $Q$ . In Figure 1.6.5 these functions are shown for the case:

$$r = 0, \quad H = 5 \text{ m}, \quad D = 3 \text{ m}$$



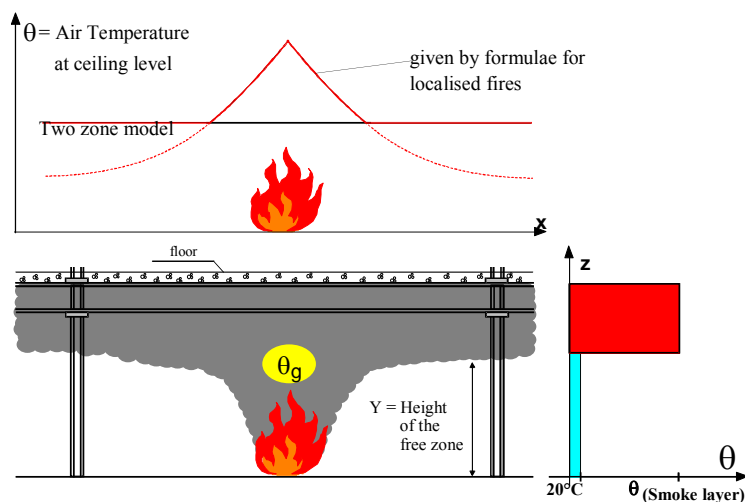
**Fig.1.6.5**  $q''$  as a function of  $y$  and  $Q$

#### 1.6.2.4 Combination of two-zone model and localised fire model

In a localised fire the gas temperature distribution in the compartment may be estimated by a two-zone model. In this model the gas temperature in each layer is calculated with the hypothesis that it is uniform in each layer. This average temperature in the hot zone is generally sufficiently accurate as far as global phenomena are considered: quantity of smoke to be extracted from the compartment, likelihood of flashover, total collapse of the roof or ceiling, etc.

When it comes to estimating the local behaviour of a structural element located just above the fire, the hypothesis of a uniform temperature may be unsafe and the two-zone model has to be combined with the localised fire formula given at §1.6.1.3.

The temperatures close to the beam are obtained by – for each point alongside the beam – taking the highest temperature predicted by each of the models.



**Fig.1.6.6** Combination of two-zone with localised fire model

The height of the smoke zone and the temperatures of the hot gases at the level of the steel structures at different distances from the fire can be calculated by the model TEFINAF [8]. This model combines a two-zone model which provides the height and the mean temperature of the hot zone and the localised fire formula which gives the temperature peak just above the fire and at different distances from the fire.

### 1.6.3 Fully engulfed fire

To model a fully engulfed fire within a building there are several types of models. Some of the most widely used are described in this section.

The natural fire concept is an alternative to the nominal fires defined in prescriptive codes (ISO, hydrocarbon curves...).

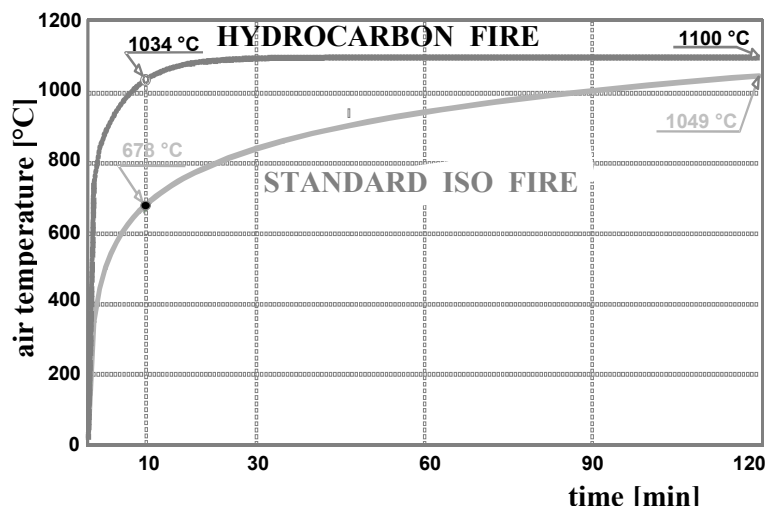


Fig.1.6.7 Standard- and Hydrocarbon fire curves

The field models (CFD) are not included in this section. They are too complex and need too much time and data in order to use them as a simple engineering tool.

### 1.6.3.1 Parametric fires

Parametric fires provide a simple means to take into account the most important physical phenomenon, which may influence the development of a fire in a particular building. Like nominal fires, they consist of time temperature relationships, but these relationships contain some parameters deemed to represent particular aspects of reality.

In almost every parametric fire which can be found in the literature, the parameters taken into account, in one way or another, are:

- the geometry of the compartment
- the fire load within the compartment,
- the openings within the walls and/or in the roof and
- the type and nature of the different construction elements forming the boundaries of the compartment.

Parametric fires are based on the hypothesis that the temperature is uniform in the compartment, which limits their field of application to post-flashover fires in compartments of moderate dimensions. They nevertheless constitute a significant step forward toward the consideration of the real nature of a particular fire when compared to nominal fires, while still having the simplicity of some analytical expressions, i.e. no sophisticated computer tool is required for their application.

A proposal is made in the informative Annex A of EN 1991-1-2 [1] for such a parametric fire. It is valid for compartments up to 500 m<sup>2</sup> of floor area, without openings in the roof and for a maximum compartment height of 4 m.  $b$  must be in the range 100 to 2200 J/m<sup>2</sup>s<sup>1/2</sup>K, and  $O$  must be comprised between 0,02 and 0,20 ( $O$  and  $b$  are defined here below).

Some corrections have been made to improve the proposal of the ENV1991-2-2 [23]. They are:

- a more correct way to calculate thermal effusivity ( $b$  factor) in walls made of layers of different materials;



- the introduction of a minimum duration of the fire, taking into account a fuel controlled fire when the fire load is low and the openings are large;
- a correction factor which takes into account the large mass flow through opening in case of fuel controlled fires.

This new formulation of the parametric fire is now presented and is valid for any b.

The evolution of the gas temperature within the compartment is given by:

$$\theta_g = 1325 \left( 1 - 0,324 e^{-0,2t^*} - 0,204 e^{-1,7t^*} - 0,472 e^{-19t^*} \right) + 20^\circ\text{C} \quad (1.6)$$

with

$$t^* = \Gamma t \quad (1.7)$$

$$\Gamma = \frac{(O/0,04)^2}{(b/1160)^2} \quad (1.8)$$

$$O = A_v \sqrt{h} / A_t \quad (1.9)$$

and

- t time, in hour,
- $A_v$  area of vertical openings, in  $\text{m}^2$ ,
- h height of vertical openings, in m,
- $A_t$  total area of enclosure (walls, ceiling and floor, including openings), in  $\text{m}^2$ ,
- b is the so-called b-factor in  $[\text{J}/\text{m}^2\text{s}^{1/2}\text{K}]$ . It is function of thermal inertia of boundaries (see §1.3.3 for b calculation).

The duration of the heating phase is determined by:

$$t_{\max} = \max \left( 0,2 \cdot 10^{-3} q_{t,d} / O ; t_{\text{lim}} \right) \quad [\text{hour}] \quad (1.10)$$

with

- $q_{t,d}$  design value of the fire load density related to  $A_t$ , in  $\text{MJ}/\text{m}^2$ ,
- $t_{\text{lim}}$  20 minutes, similar to the free burning fire duration  $\tau_F$  assumed in Annex B of EN 1991-1-2 [1].

When applying Eqn.(1.10), two different possibilities exist:

Either the duration of the heating phase of the fire calculated from the first term of the equation  $0,2 \cdot 10^{-3} q_{t,d} / O$ , is larger than the chosen limit time  $t_{\text{lim}}$ , in which case Eqns.(1.6) to (1.9) and Eqns.(1.16) to (1.18) are applied as such, without any modification.

Or the duration of the heating phase of the fire calculated from the first term of the equation  $0,2 \cdot 10^{-3} q_{t,d} / O$ , is shorter than the chosen limit time  $t_{\text{lim}}$ . In this case, Eqns.(1.6) to (1.9) are applied with a modified opening factor,  $O_{\text{lim}}$ , calculated as the one leading to the chosen limit time from the following equation:

$$O_{\text{lim}} = 0,1 \cdot 10^{-3} q_{t,d} / t_{\text{lim}} \quad (1.11)$$

Eqns.(1.10) and (1.11) are modified in the following way:

$$t_{\text{lim}}^* = \Gamma_{\text{lim}} t \quad (1.12)$$

$$\Gamma_{\text{lim}} = \frac{(O_{\text{lim}}/0,04)^2}{(b/1160)^2} \quad (1.13)$$

and  $t_{\text{lim}}^*$  is used in Eqn.(1.6) instead of  $t^*$ .

Last, in order to take the effect of the ventilation during the heating phase, in the case of  $t_d = t_{\text{lim}}$ :

If  $O > 0,04$  and  $q_{t,d} < 75$  and  $b < 1160$

then

$$k = 1 + \left( \frac{O - 0,04}{0,04} \right) \left( \frac{q_{t,d} - 75}{75} \right) \left( \frac{1160 - b}{1160} \right) \quad (1.14)$$

and

$$\Gamma_{\text{lim}} = k \frac{(O_{\text{lim}}/0,04)^2}{(b/1160)^2} \quad (1.15)$$

The temperature-time curve during the cooling phase is given by:

$$\theta_g = \theta_{\text{max}} - 625 (t - t_{\text{max}}^* x) \quad \text{for } t_d^* \leq 0,5 \quad (1.16)$$

$$\theta_g = \theta_{\text{max}} - 250 (3 - t_d^*) (t - t_{\text{max}}^* x) \quad \text{for } 0,5 \leq t_d^* \leq 2,0 \quad (1.17)$$

$$\theta_g = \theta_{\text{max}} - 250 (t - t_{\text{max}}^* x) \quad \text{for } 2,0 \leq t_d^* \quad (1.18)$$

with  $\theta_{\text{max}}$  maximum temperature at the end of the heating phase given by Eqn.(1.6) where  $t = t_d$  given by Eqn.(1.10).

$$t_{\text{max}}^* = (0,2 \cdot 10^{-3} q_{t,d} / O) \Gamma$$

$$x = 1 \quad \text{for } t_{\text{max}} > t_{\text{lim}}$$

$$x = \frac{t_{\text{lim}}}{t_{\text{max}}^*} \quad \text{for } t_{\text{max}} = t_{\text{lim}}$$

An example of results (fire load  $q_{t,d} = 180 \text{ MJ/m}^2$ ,  $b = 1160 \text{ J/m}^2\text{s}^{1/2}\text{K}$ , opening factor  $O$  from  $0,04 \text{ m}^{1/2}$  to  $0,20 \text{ m}^{1/2}$ ) is shown on Figure 1.6.8.

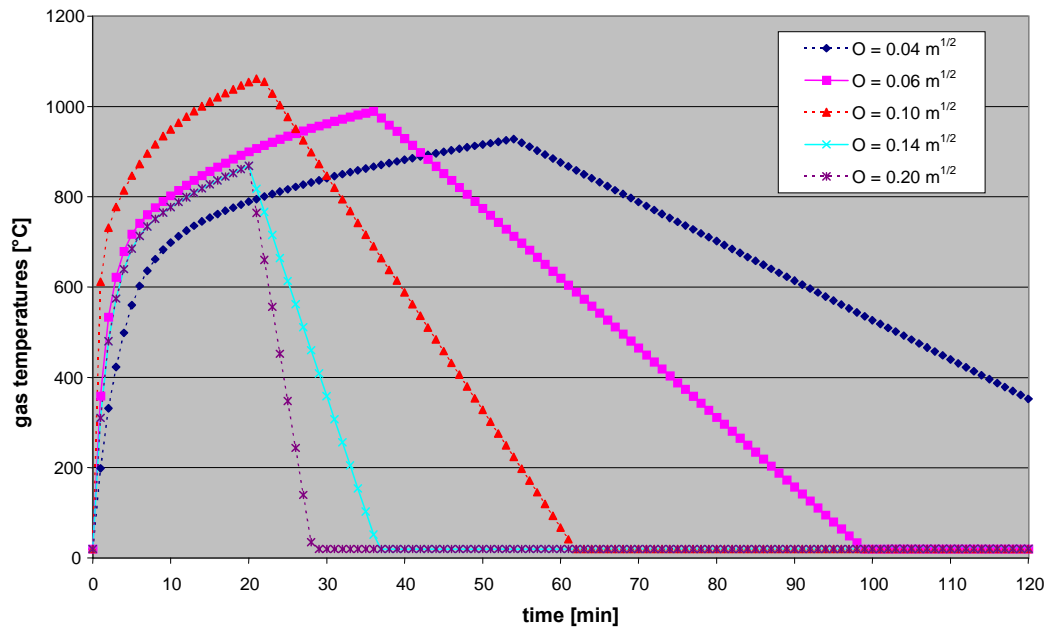


Fig.1.6.8 Example of parametric fires [1]

With the parametric fire, the comparison has been made between the results of tests [12] and the results of the improved predictions. Figure 1.6.9 concerns the maximum temperature in the gas. The coefficient of correlation, which had the value of 0,19 with the formulas of the ENV 1991-2-2 [23], has now a value of 0,83.

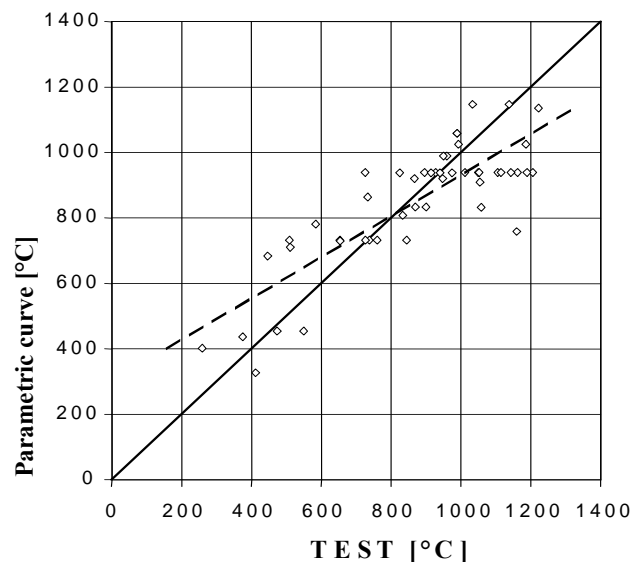


Fig.1.6.9 Maximum gas temperature in the compartment

### 1.6.3.2 Zone models

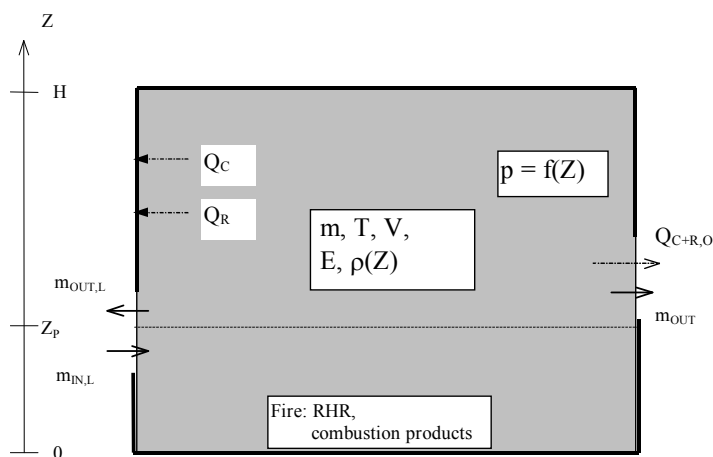
Zone models have been already introduced in §1.6.1.1, where a short description of a two-zone model was presented. The application field of a two-zone model is the pre-flashover phase of the fire. For a fully engulfed fire a one-zone model should be used.

### 1.6.3.3 One-zone model

The one-zone model is based on the fundamental hypothesis that, during the fire, the gas temperature is uniform in the compartment. One-zone models are valid for post-flashover conditions.

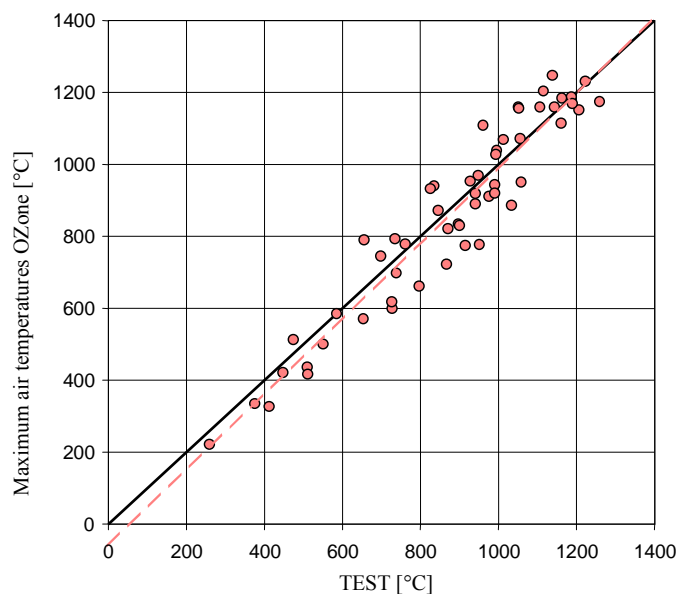
The data have to be supplied with a higher degree of detail than for the parametric curves and are the same, as those required for a two-zone model.

Figure 1.6.10 shows how a compartment fire is modelled, with different terms of the energy and mass balance represented.



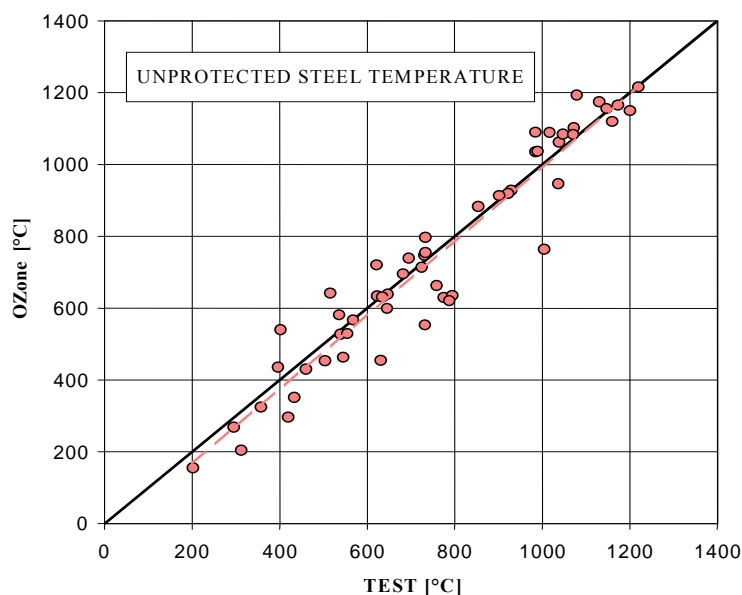
**Fig.1.6.10** A compartment in a one-zone model

In the scope of the ECSC projects NFSC 1 & 2 [11, 12] the two-zone model OZone, has been developed at University of Liège together with PROFILARBED-Research and has been validated, taking as reference the results of 54 experimental tests. Figure 1.6.11 gives a comparison of the maximum gas temperature as measured in the test and computed by the model. Each point is representative of a test and the oblique line is the location of the points giving a perfect fit. The dotted line is the linear regression among all points.



**Fig.1.6.11** Maximum gas temperature in the compartment

Another comparison is represented in Figure 1.6.12. For each test, the temperature evolution was computed in a typical unprotected steel section - HEB 200, with section factor  $A_m/V = 147 \text{ m}^{-1}$  - first submitted to the recorded gas temperature, then submitted to the computed gas temperature. This allowed to draw the graph where each test is represented by the maximum temperature in the unprotected steel section.



**Fig.1.6.12** Maximum temperature in the unprotected steel section

#### 1.6.4 Combination of one-zone and two-zone models. Choice of the model

After having defined the fire characteristics, i.e. RHR curve, compartment geometry, wall characteristics, it is necessary to choose the natural fire model to apply according to the considered scenario. This choice will be made in accordance with the application domain of the models.

In this consideration, it is assumed that the first application has to be a “two-zone model” application. The question is how and when the transition from the “two-zone model” application to a “one-zone model” application occurs.

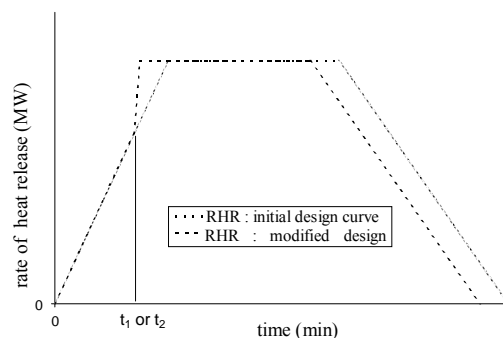
The results of a “two-zone model” are given in the form of two main variables:

- temperature of the upper zone  $T_u$ ;
- height of the interface of the two zones  $H_i$

These two variables will condition the simulation with the zone model (see Figure 1.6.15). The four following conditions are able to limit the application of a “two-zone model”:

- condition 1 (C1):  $T_u > 500^\circ\text{C}$   
the high temperature of combustion products (higher than  $500^\circ\text{C}$ ) leads to a flashover by radiative flux to the other fire loads of the compartment;
- condition 2 (C2):  $H_i < H_q$  and  $T_u > T_{\text{ignition}}$   
the decrease of the interface height ( $H_i$ ) is such that the combustible material is in the smoke layer (maximum height with combustible  $H_q$ ), and if the smoke layer has a high temperature (higher than  $T_{\text{ignition}}$  which is assumed be  $300^\circ\text{C}$ ), leads to propagation of fire in all compartment by combustible ignition;
- condition 3 (C3):  $H_i < 0,1H$   
the interface height goes down and leads to a very small lower layer thickness, which is not representative of two-zone phenomenon;
- condition 4 (C4):  $A_{fi} > 0,5A_f$   
the fire area is too high compared to the floor surface of the compartment to consider a localised fire.

In fact, the conditions 1 or 2 lead to a modification of the initial rate of heat release (simulation with two-zone model), for a one-zone model simulation. This modification is made as indicated in Figure 1.6.13.



**Fig.1.6.13** Design curves for rate of heat release of the fire

The above approach is presented in the scheme of Figure 1.6.14. In this scheme it is shown under which conditions (two- or one-zone modelling) the design temperature curves have to be determined.

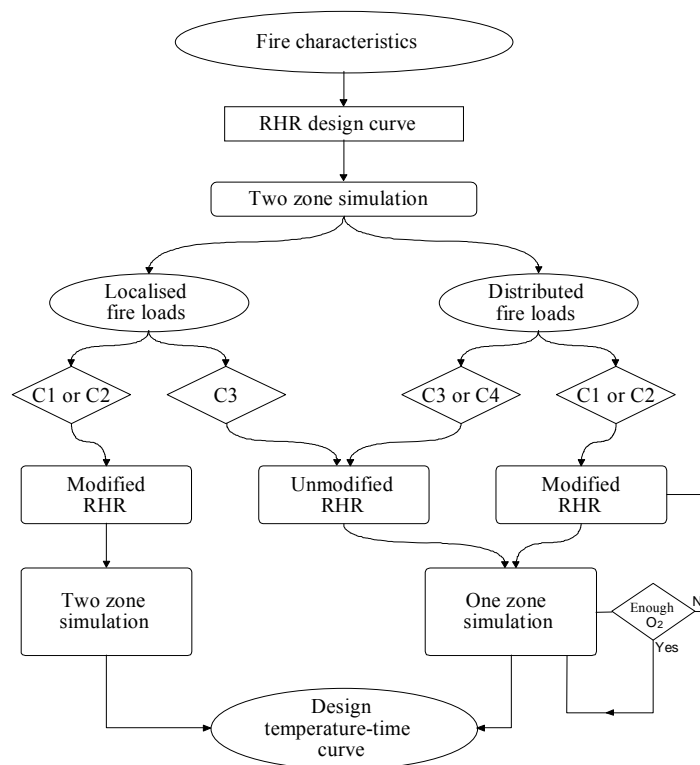


Fig.1.6.14 Combination of one- and two-zone model

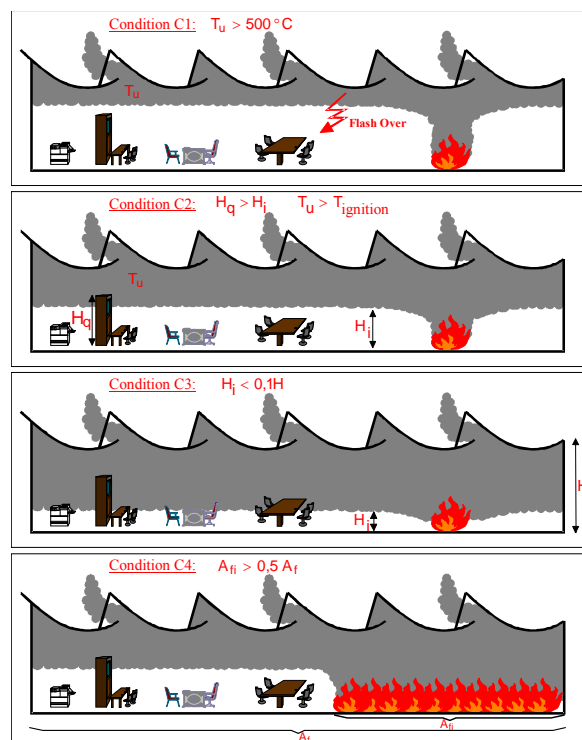


Fig.1.6.15 Limits of application of two-zone model

## 1.7 Mechanical actions according to Eurocodes

Under the fire situation, the applied loads to structures can be obtained according to following formula (see relation 6.11b of EN 1990):

$$\sum_{i \geq 1} G_{k,j} + (\Psi_{1,1} \text{ or } \Psi_{2,1}) Q_{k,1} + \sum_{i \geq 1} \Psi_{2,i} Q_{k,i}$$

where:

- $G_{k,j}$  characteristic values of permanent actions
- $Q_{k,1}$  characteristic leading variable action
- $Q_{k,i}$  characteristic values of accompanying variable actions
- $\Psi_{1,1}$  factor for frequent value of a variable action
- $\Psi_{2,i}$  factor for quasi-permanent values of variable actions

The recommended values of  $\Psi_1$  and  $\Psi_2$  are given in Table 1.7.1 (table A1.1 of EN 1990) but could be modified in the National Annex.

**Table 1.7.1** Recommended values of  $\Psi$  factors for buildings

Action	$\Psi_0$	$\Psi_1$	$\Psi_2$
Imposed loads in buildings, category (see EN 1991-1.1)			
Category A : domestic, residential areas	0,7	0,5	0,3
Category B : office areas	0,7	0,5	0,3
Category C : congregation areas	0,7	0,7	0,6
Category D : shopping areas	0,7	0,7	0,6
Category E : storage areas	1,0	0,9	0,8
Category F : traffic area vehicle weight $\leq 30$ kN	0,7	0,7	0,6
Category G : traffic area, 30 kN < vehicle weight $\leq 160$ kN	0,7	0,5	0,3
Category H : roofs	0	0	0
Snow loads on buildings (see EN1991-1.3)			
Finland, Iceland, Norway, Sweden	0,70	0,50	0,20
Remainder of CEN Member States, for sites located at altitude H > 1000 m a.s.l.	0,70	0,50	0,20
Remainder of CEN Member States, for sites located at altitude H $\leq$ 1000 m a.s.l.	0,50	0,20	0
Wind loads on buildings (see EN1991-1.4)	0,6	0,2	0
Temperature (non-fire) in buildings (see EN1991-1.5)	0,6	0,5	0

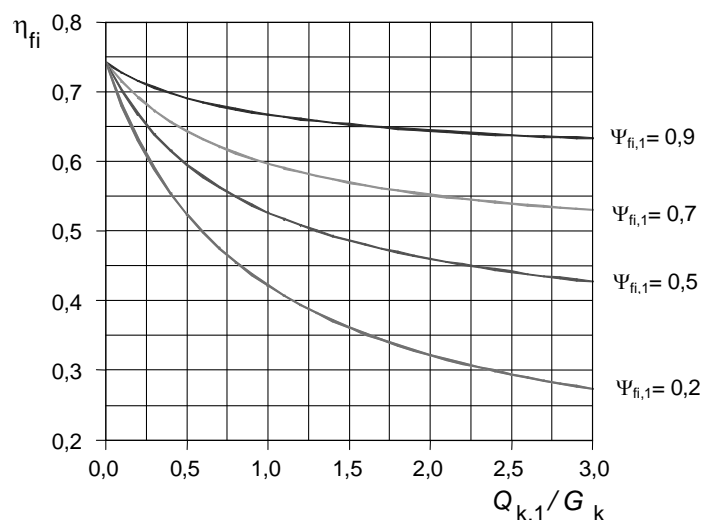
Another important notation largely used in fire design methods of Eurocodes is the load level for the fire situation  $\eta_{fi,t}$  which is defined as  $\eta_{fi,t} = E_{d,fi}/E_d$  with  $E_d$  and  $E_{d,fi}$  the design effect of actions at room temperature design and the design effect of actions for the fire situation, respectively. It can be alternatively determined by:

$$\eta_{fi,t} = \frac{G_k + \Psi_{fi,1} Q_{k,1}}{\gamma_G G_k + \gamma_{Q,1} Q_{k,1}}$$

where  $\gamma_{Q,1}$  is the partial factor for leading variable action 1.



In fact, the load level  $\eta_{fi}$  depends strongly on the factor  $\psi_{1,1}$  which varies as function of building categories. In EN 1993-1-2 (fire part for steel structures) and EN 1994-1-2 (fire part for composite structures), following figure (Figure 1.7.1) is provided to show clearly the influence of both load ratio  $Q_{k,1}/G_k$  and the factor  $\psi_{1,1}$  on load level.



**Fig.1.7.1** Variation of the reduction factor  $\eta_{fi}$  with the load ratio  $Q_{k,1}/G_k$

## 1.8 Conclusion

This chapter presents the various models available to calculate the temperature inside a compartment as a function of time as well as the needed data. To know the temperature of the structural elements as a function of time, it is necessary to calculate the heat flux to these elements.

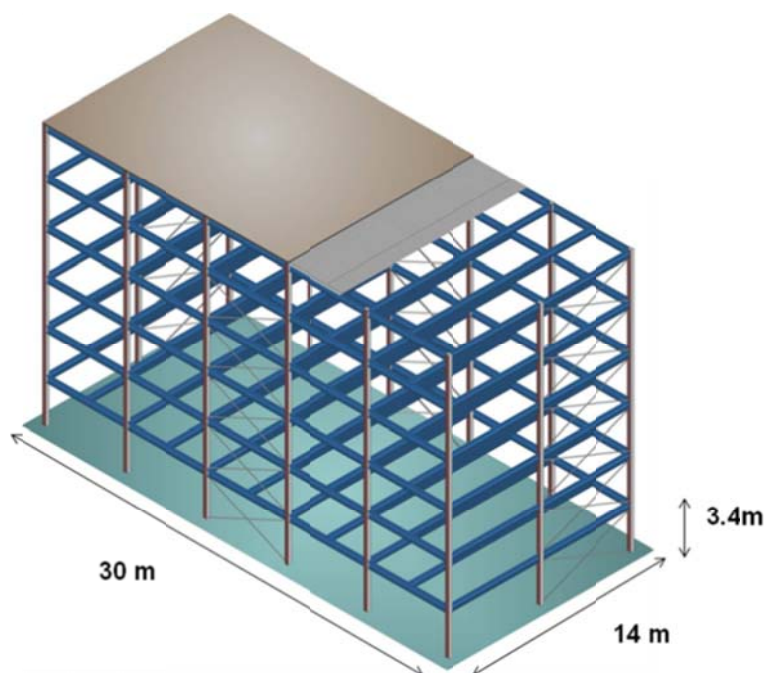
Convective and radiative heat transfer occur between the hot gases, the flame, the surrounding boundary constructions and the structural element. Emissivities and convection coefficients govern the heat transfer.

The heating up of a structural element depends on the type of element (e.g. pure steel or composite-steel/concrete) and of the nature and amount of fire protection. This is the subject of the other parts of the report dealing with the different materials.

## 1.9 Worked example

### 1.9.1 Fire developing in a compartment

Fig.1.9.1 here after is showing the global geometry of the chosen building:



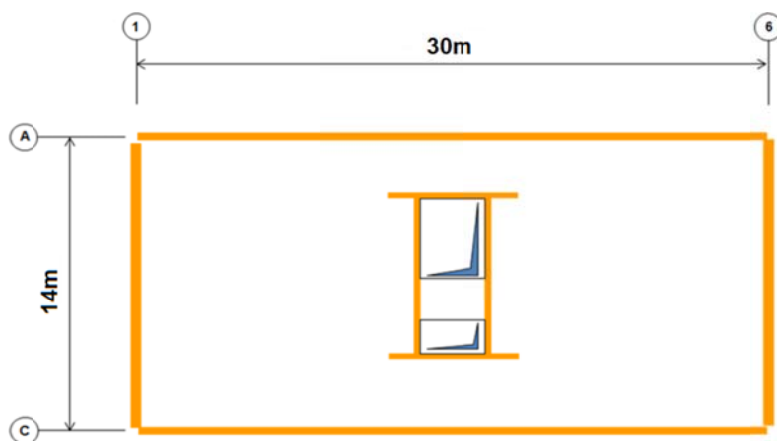
**Fig.1.9.1** Global dimensions of the building

This building corresponds to a generic modern office building. In order to use EN 1991-1-2 Annex E it is necessary to have different information about the building:

Size of the compartment	}	Geometry
Boundary properties		
Ceiling height		
Opening area		
Fire surface	}	Fire

**Size of the compartment:**

For this example, it has been chosen, as shown in Figure 1.9.2, that the entire surface of one floor will be considered as a compartment.



**Fig.1.9.2** Size of the fire compartment

The national regulation could impose a limit in the size of the compartment but in our case, the size is 420 m<sup>2</sup> which is not really a huge compartment.

The software package that will be used to perform this calculation is OZone. This software package has been developed by the University of Liège [25,26] and is available for free download on:

- <http://www.argenco.ulg.ac.be/logiciel.php>
- <http://www.arcelormittal.com/sections>

For the next steps of this case study will be shown how to use EN 1991-1-2 Annex E, using this software package. The first step of the calculation is the determination of the size of the compartment.

In our case, the dimensions of the compartment are:

- Height: 3,05m
- Depth: 14m
- Length: 30m

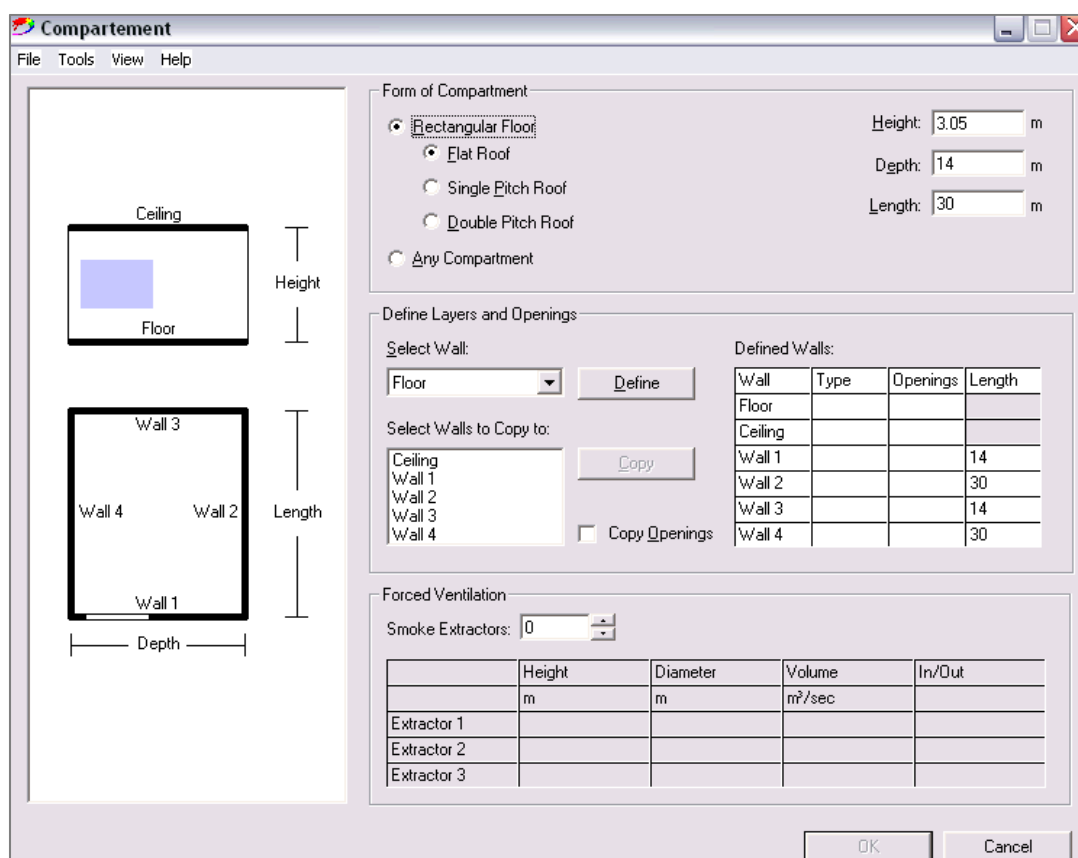
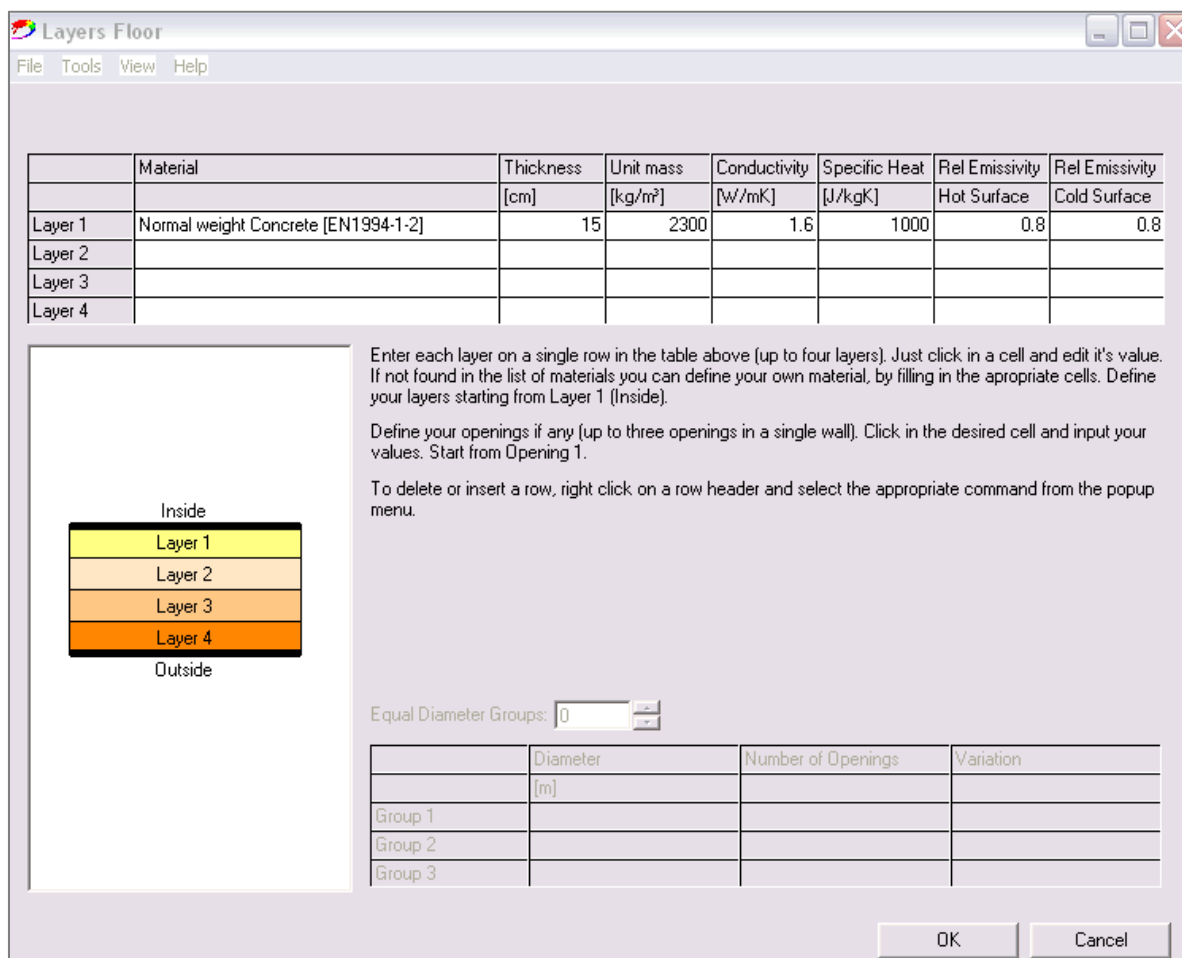


Fig.1.9.3 Definition of the compartment in the OZone software Interface

In order to define the boundaries of the compartment, it is necessary to do assumptions. Typical floor will be chosen for this building:

- Exterior walls: 20 cm of normal concrete
- Slab: 15 cm of normal concrete
- Ceiling: 15 cm of normal concrete



**Fig.1.9.4** Definition of the boundaries condition in the OZone software interface

For the definition of the openings in the facade, the Eurocodes are not providing the scenario that must be chosen to take into account.

Openings can be doors, windows and general « porosity » of the building.

If no opening is taken into account from the beginning of the fire, the amount of oxygen in the compartment will be too small and the fire will not develop.

Some information can be found in the literature on the behaviour of glazing subjected to fire:

- Normal glazing will start to break with a  $\Delta T$  of 40°C on the glass
- Tempered glazing will start to break with a  $\Delta T$  of 120°C on the glass
- Tempered glazing with reinforcement will start to break with a  $\Delta T$  of 120°C on the glass (the reinforcement will melt at 300°C)

Luxembourgish authorities have released a guide that has to be followed when FSE is used. This guide "ITM-SST 1551.1" can be found on [http://www.itm.lu/securite-sante-ss/conditions\\_types/conditions\\_types\\_doc/1551-1-stabilite-au-feu.pdf/view](http://www.itm.lu/securite-sante-ss/conditions_types/conditions_types_doc/1551-1-stabilite-au-feu.pdf/view).

Here is some extract for the non fire resistant glazing:

- Scenario 1: 90% of the glazing is open since the beginning

- Scenario 2:
  - Simple glazing: 100°C: 50% and 250°C: 90%
  - Double glazing: 200°C: 50% and 400°C: 90%
  - Triple glazing: 300°C: 50% and 500°C: 90%

In order to illustrate the influence of the facade system on the results, 3 different examples will be taken into account:

- Example 1: 0,8m open all around the building
- Example 2: 1,5m open all around the building
- Example 3: full glazing facade

In order to introduce glazing surface into the OZone software, openings must be added to the facade and a “stepwise” variation must be chosen.

With this “stepwise” variation, it is possible to define a scenario of opening depending on the temperature.

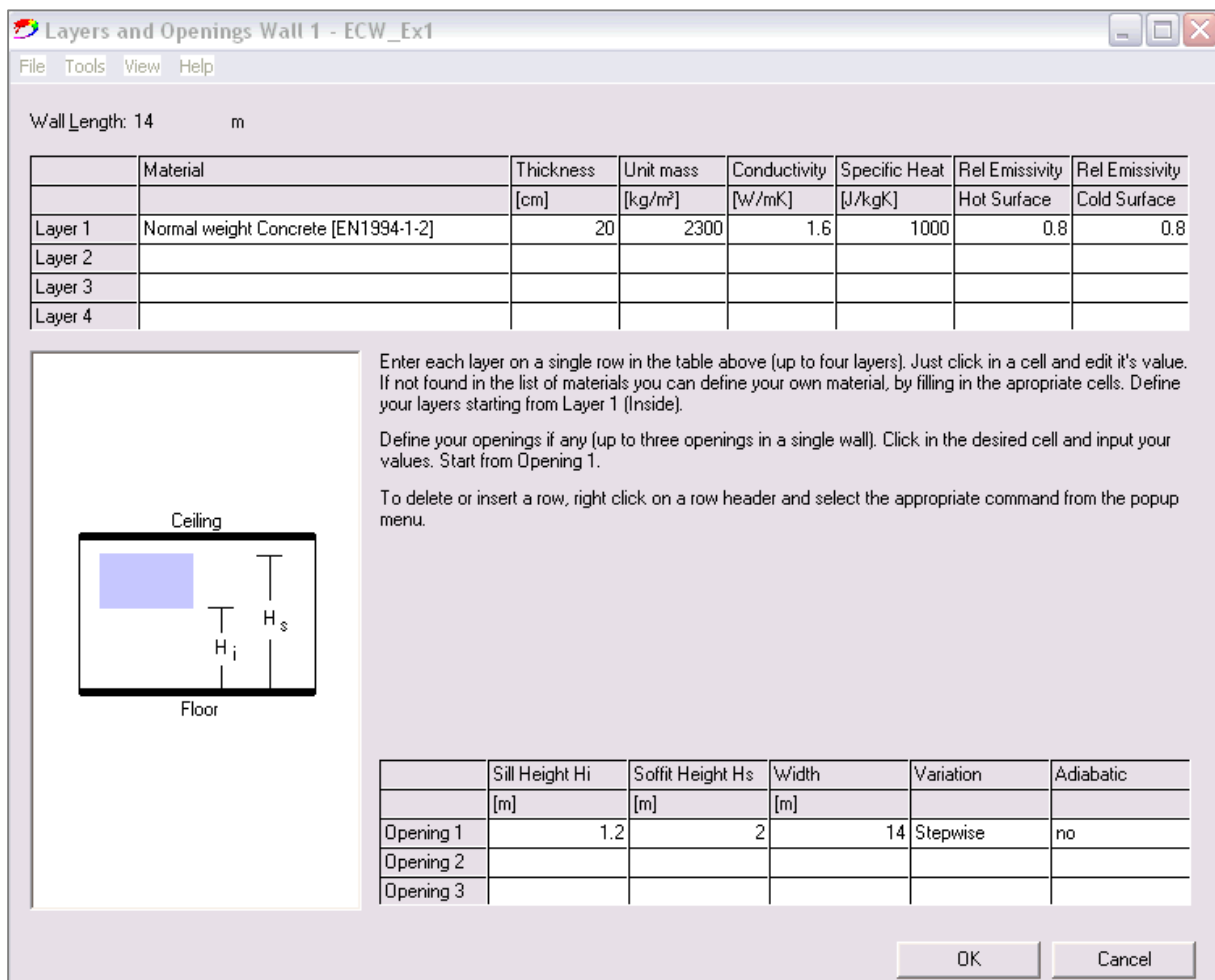


Fig.1.9.5 Introduction of the first example of facade opening into the OZone software interface.

The glazing system will be defined as double glazing and Scenario 2 of the Luxembourgish guide will be taken into account for the breaking of the glazing surface with the temperature.

In the folder “Parameters”, it is possible to define the “Stepwise” (% of opening depending on the temperature).

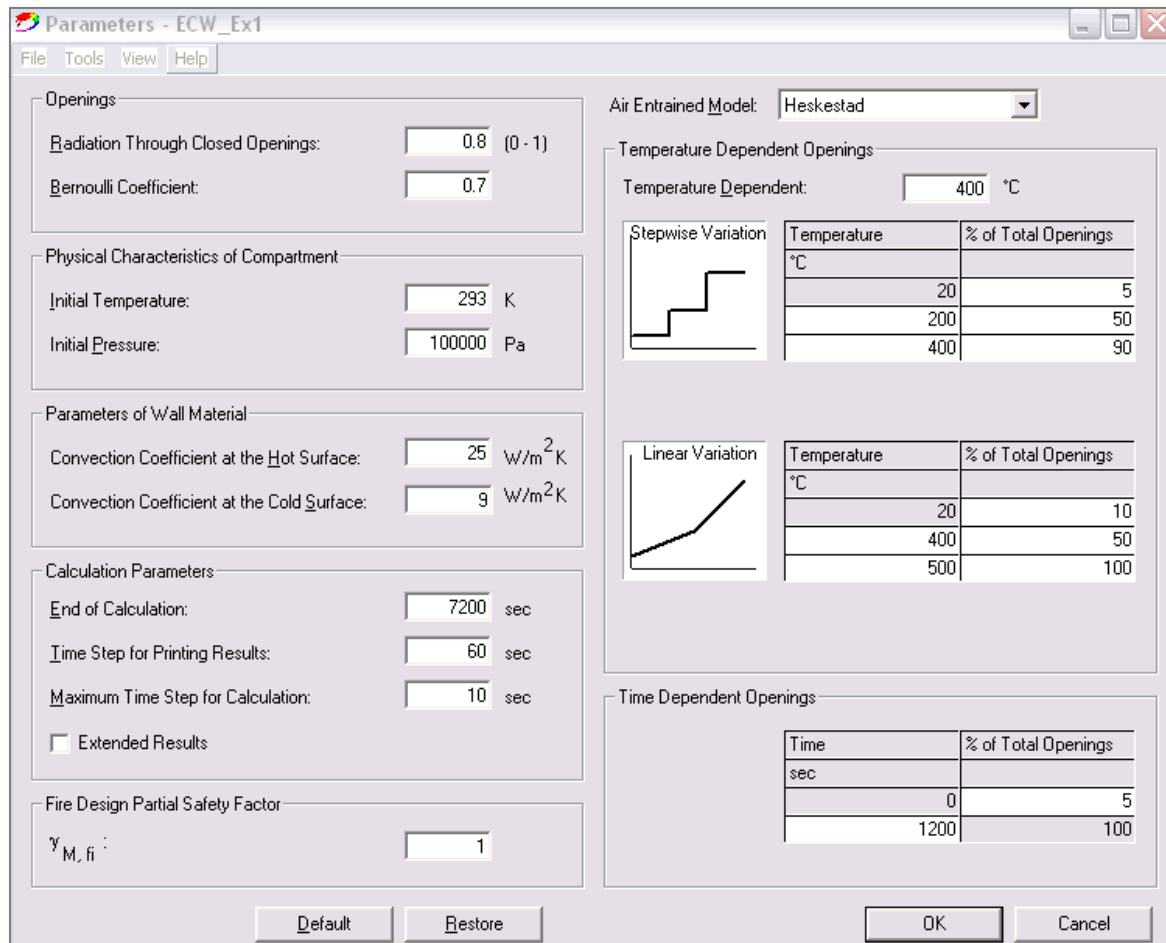


Fig.1.9.6 Parameters of the “stepwise” opening in the OZone software interface.

### Determination of fire load density

For the determination of the fire load density the Annex E of EN 1991-1-2 offers a calculation model. The design value of the load density may either be given by a national fire load classification of occupancies and/or be specified for an individual project by performing a fire load evaluation.

At this example, the second method is chosen.

$$q_{f,d} = q_{f,k} m \delta_{q1} \delta_{q2} \delta_n$$

where:

- m the combustion factor
- $\delta_{q1}$  the factor considering the danger of fire activation by size of the compartment
- $\delta_{q2}$  the factor considering the fire activation risk due to the type of occupancy
- $\delta_n$  the factor considering the different active fire fighting measures

The fire load consisted of 20 % plastics, 11 % paper and 69 % wood, so it consisted mainly of cellulosic material. Therefore the combustion factor is:

$$m = 0,8$$

The factor  $\delta_{q1}$  considers the danger of fire activation by size of the compartment, as given in Table 1.9.1.

**Table 1.9.1** Fire activation risk due to the size of the compartment (see EN 1991-1-2, Table E.1)

	Compartment floor area $A_f$ [m <sup>2</sup> ]				
	$\leq 25$	$\leq 250$	$\leq 2500$	$\leq 5000$	$\leq 10000$
Danger of fire activation $\delta_{q1}$	1,10	1,50	1,90	2,00	2,13

Size of the compartment: 420m<sup>2</sup>

By linear interpolation:  $\delta_{q1} = 1,59$

A factor  $\delta_{q2}$  considers the fire activation risk due to the type of occupancy, as given in Table 1.9.2.

**Table 1.9.2** Fire activation risk due to the type of occupancy (see EN 1991-1-2, Table E.1)

Danger of fire activation $\delta_{q2}$	Examples of occupancies
0,78	artgallery, museum, swimming pool
1,00	offices, residence, hotel, paper industry
1,22	manufactory for machinery & engines
1,44	chemical laboratory, painting workshop
1,66	manufactory for fireworks or paints

$$\delta_{q2} = 1$$

The factor taking the different active fire fighting measures into account is calculated to:

$$\delta_n = \prod_{i=1}^{10} \delta_{ni}$$

The factors  $\delta_{ni}$  are given in Table 1.9.3.

**Table 1.9.3** Factors  $\delta_{ni}$  (see EN 1991-1-2, Table E.2)

$\delta_{ni}$ <b>Function of Active Fire Fighting Measures</b>	Automatic fire suppression	Automatic water extinguishing system	$\delta_{n1}$	0,61	
		Independent water supplies	0	1,0	
			1	$\delta_{n2}$	0,87
	Automatic fire detection	Automatic fire detection & alarm	by heat	$\delta_{n3}$	0,87
			by smoke	$\delta_{n4}$	0,73
		Automatic fire transmission to fire brigade	$\delta_{n5}$	0,87	
	Manual fire suppression	Work fire brigade	$\delta_{n6}$	0,61	
		Work fire brigade	$\delta_{n7}$	0,78	
		Safe Access Routes	$\delta_{n8}$	0,9 or 1,0 or 1,5	
		Fire Fighting Devices	$\delta_{n9}$	1,0 or 1,5	
Smoke Exhaust System		$\delta_{n10}$	1,0 or 1,5		

As there is only a sprinkler system and detection by smoke,  $\delta_{ni} = 0,4453$ .

For calculating the characteristic fire load, the characteristic fire load has to be determined using the table of EN 1991-1-2 Annex E. It can be extracted from the table that for office buildings, 511 MJ/m<sup>2</sup> must be taken into account.

**Table 1.9.4** Fire load densities  $q_{f,k}$  [MJ/m<sup>2</sup>] for different occupancies (see EN 1991-1-2, Table E.4)

Occupancy	Fire growth rate	RHR <sub>f</sub> [kW/m <sup>2</sup> ]	Fire load $q_{f,k}$ 80% fractile [MJ/m <sup>2</sup> ]
Dwelling	Medium	250	948
Hospital (room)	Medium	250	280
Hotel (room)	Medium	250	377
Library	Fast	500	1824
Office	Medium	250	511
School	Medium	250	347
Shopping centre	Fast	250	730
Theatre (movie/cinema)	Fast	500	365
Transport (public space)	Slow	250	122

Figure 1.9.7 shows this selection of parameters in the OZone software interface.



**Fire - ECW\_Ex1**

File Tools View Help

Fire Curve  
 EN 1991 - 1 - 2       User Defined Fire

Occupancy	Fire Growth Rate	RHRf [kW/m²]	Fire Load q <sub>f,k</sub> 80% Fractile [MJ/m²]	Danger of Fire Activation	
Office (standard)	Medium		250	511	1

Active Fire Fighting Measures

- Automatic Water Extinguishing System       $\delta_{n,1} = 0.61$
- Independent Water Supplies (  1    2 )       $\delta_{n,2} = 1$
- Automatic Fire Detection by Heat       $\delta_{n,4} = 0.73$
- Automatic Fire Detection by Smoke
- Automatic Alarm Transmission to Fire Brigade       $\delta_{n,5} = 1$
- Work Fire Brigade       $\delta_{n,6} = 1$
- Off Site Fire Brigade
- Safe Access Routes       $\delta_{n,8} = 1$
- Staircases Under Overpressure in Fire Alarm
- Fire Fighting Devices       $\delta_{n,9} = 1$
- Smoke Exhaust System       $\delta_{n,10} = 1$

Fire Info  
 Max Fire Area:  m<sup>2</sup>  
 Fire Elevation:  m      Fuel Height:  m

Design Fire Load  
 Fire Risk Area:  m<sup>2</sup>       $\delta_{q,1} = 1.59$   
 Danger of Fire Activation:       $\delta_{q,2} = 1$   
 Active Measures:       $\prod \delta_{n,i} = 0.4453$   
 $q_{f,d} = \delta_{q,1} \cdot \delta_{q,2} \cdot \prod \delta_{n,i} \cdot m \cdot q_{f,k} = 289.4 \text{ MJ/m}^2$

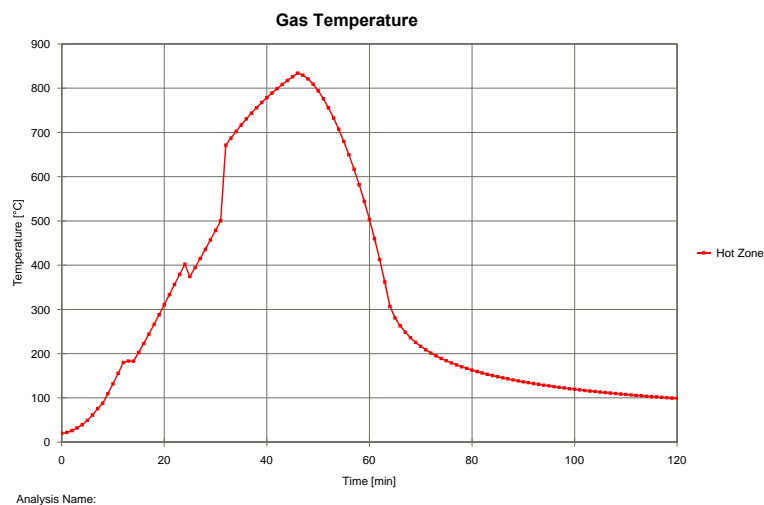
Combustion  
 Combustion Heat of Fuel:  MJ/kg  
 Combustion Efficiency Factor:   
 Combustion Model:   
 Stoichiometric Coefficient:

OK      Cancel

**Fig.1.9.7** Definition of the Fire in the OZone software interface

Having introduced all the parameters for the definition of the compartment and the fire, the calculation can be launched.

Different results can be extracted from the software. In this part of the report, only the hot zone temperature will be extracted:

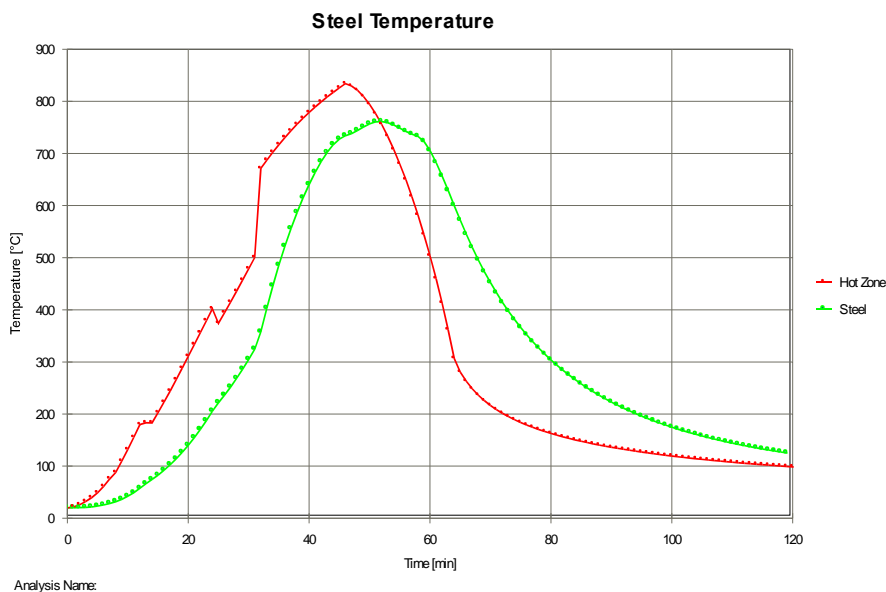


**Fig.1.9.8** Hot gases temperatures for the Example 1

On Figure 1.9.8 it can be seen that the flashover occurs after approximately 30 minutes of fire and that the maximum temperature of the hot gases is about 820°C.

Thanks to EN 1993-1-2, it will be possible, having this gas temperature, to calculate for example the temperature of an unprotected IPE450 steel profile. This technique will be explained in the devoted chapter.

As an illustration of the results, Figure 1.9.9 shows the temperature on an unprotected IPE450 steel section subjected to this natural fire.



**Fig.1.9.9** Hot gases and steel temperature

On Figure 1.9.9, it can be seen that the steel profile will reach a temperature of about 770°C. Calculated as isolated element, even with a reasonable overdesign, it will be impossible to show that this steel profile can survive to this natural fire. So with the taken assumption and with the chosen architecture for the façade, the structure must be protected.

In order to illustrate the importance of the ventilation criteria, two other examples of façade systems will be studied.

All the parameters to introduce in the software are similar at the exemption of the dimension of the glazing surface in the facade.

The second example will be a building with a 1,5 m high opening surface, passing all around the building.

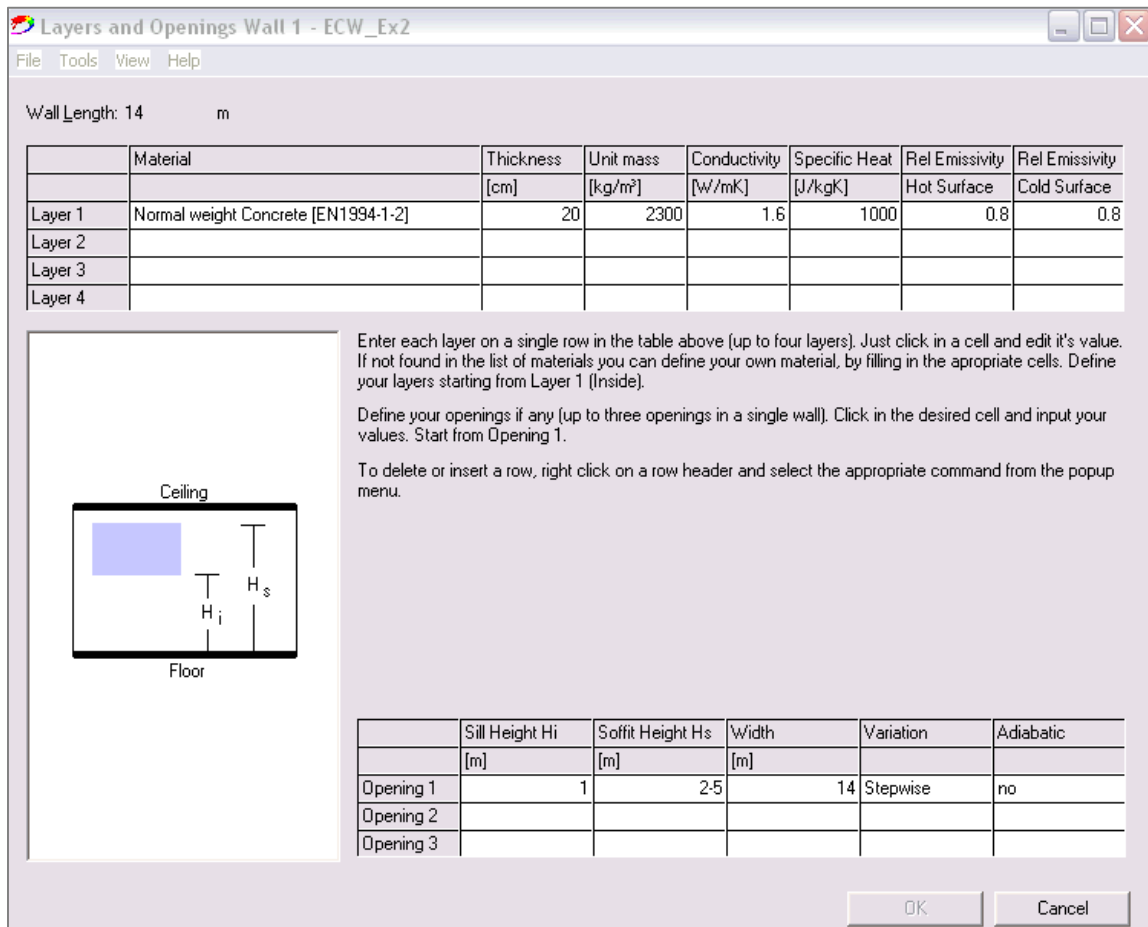


Fig.1.9.10 Introduction of the Second example of facade opening into the OZone software interface

With this new assumption, the calculation of the fire development can be relaunched and the results for the hot zone are presented in Figure 1.9.11.

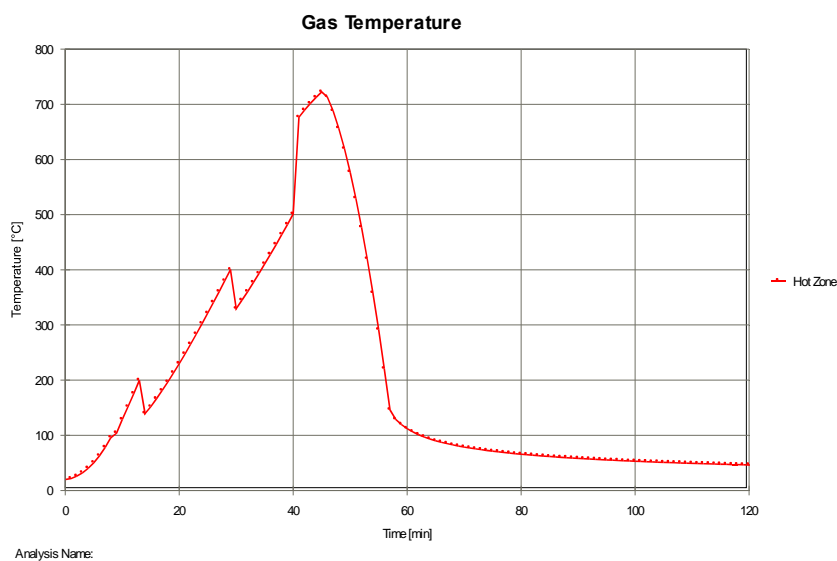
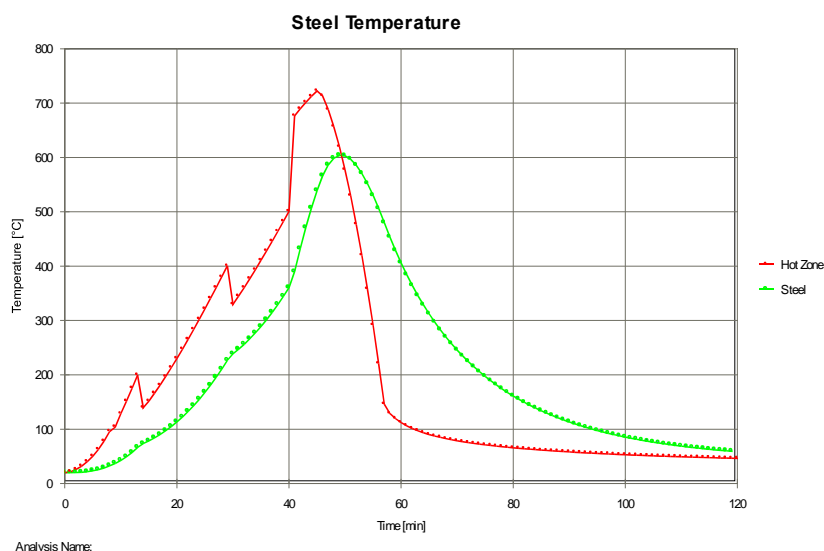


Fig.1.9.11 Hot gases temperatures for the Example 2

On Figure 1.9.11, it can be seen that the flashover occurs after approximately 40 minutes of fire and that the maximum temperature of the hot gases is about 720°C. The two drops down of the temperature (200°C and 400°C) correspond to the successive breaking of the glazing surfaces.

As an illustration of the results, Figure 1.9.12 shows the temperature on an unprotected IPE450 steel section subjected to this natural fire.



**Fig.1.9.12** Hot gases and steel temperature

On Figure 1.9.12, it can be seen that the steel profile will reach a temperature of about 600°C. Calculated as an isolated element, with a small overdesign, it must be possible to show that this steel profile can survive to this natural fire without any passive fire protection.

The third example will be a building with a 2,2 m high opening surface, passing all around the building. This corresponds to a fully glazed facade but taking into account a full facade of 1m height between two floors in order to avoid fire spreading from one floor to the other.

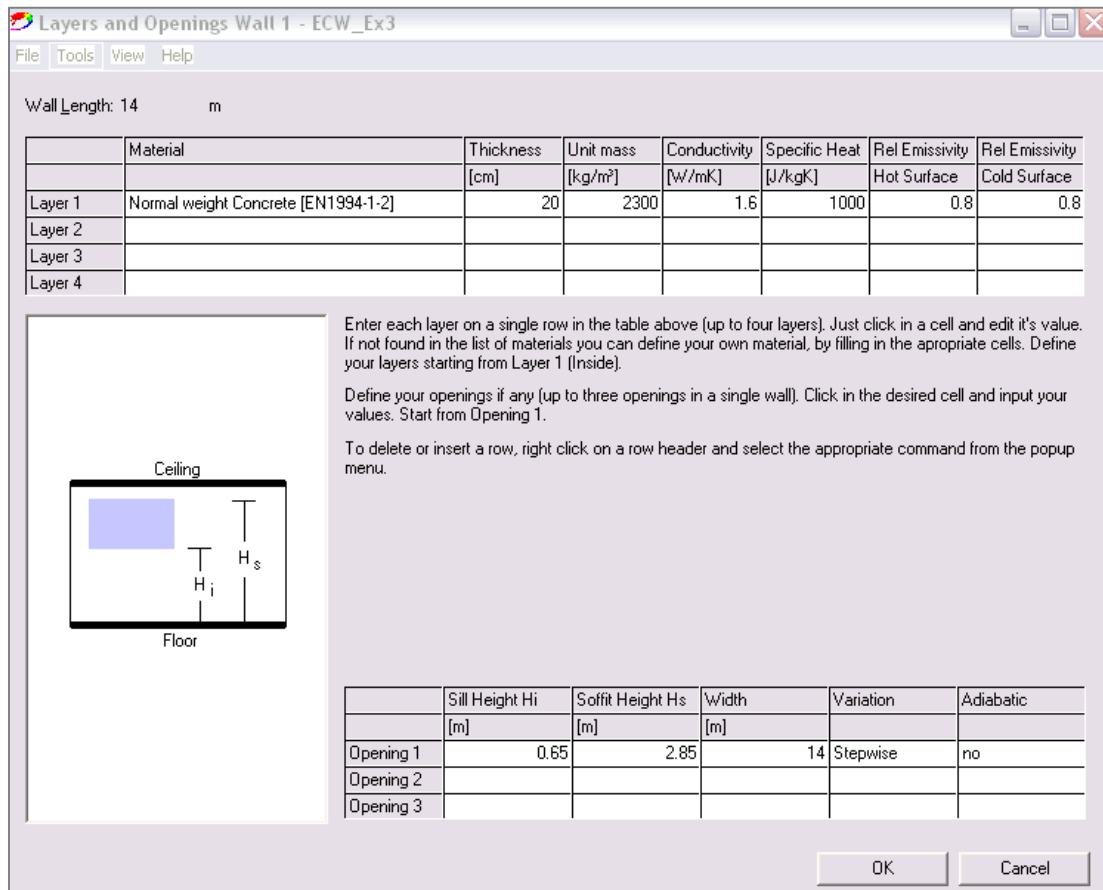


Fig.1.9.13 Introduction of the third example of facade opening into the OZone software interface

With this new assumption, the calculation of the fire development can be relaunched and the results for the hot zone are presented in Figure 1.9.14.

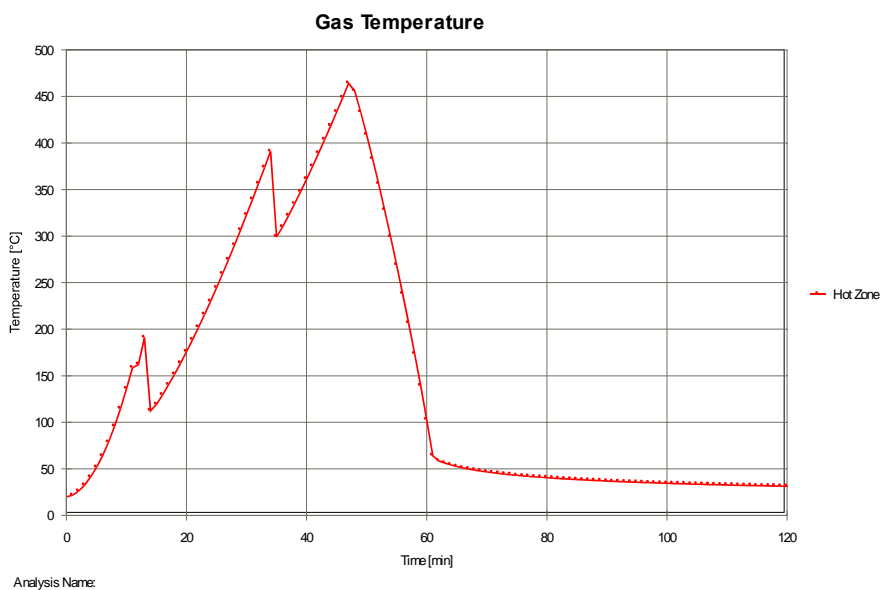
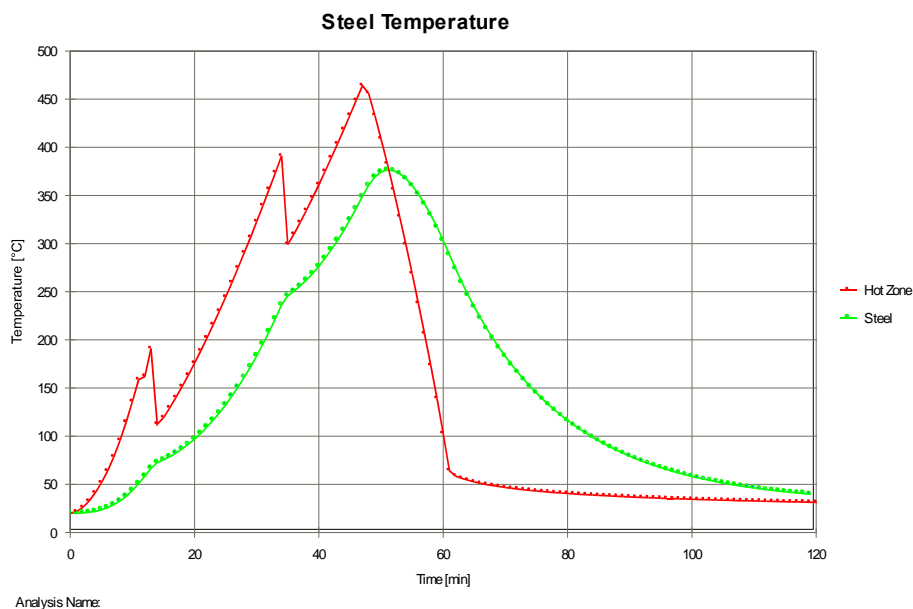


Fig.1.9.14 Hot gases temperatures for the Example 3

On Figure 1.9.14, it can be seen that no real flashover occurs in the compartment and that the maximum temperature of the hot gases is about 460°C. The two drops down of the temperature (200°C and 400°C) correspond the successive breaking of the glazing surfaces.

As an illustration of the results, Figure 1.9.15 shows the temperature on an unprotected IPE450 steel section subjected to this natural fire.



**Fig.1.9.15** Hot gases and steel temperature

On Figure 1.9.15 it can be seen that the steel profile will reach a temperature of less than 400°C. Calculated as an isolated element, without any overdesign, it must be possible to show that this steel profile can survive to this natural fire without any passive fire protection. Nevertheless, this calculation assumes only the generalized fire and the structure can also be subjected to a localized fire where locally, the temperatures will be really higher. The next paragraph will present an example of calculation taking into account a localized fire.

## 1.9.2 Localised Fire

The temperature of a steel beam has to be determined. It is part of an underground car park below the shopping mall Auchan in Luxembourg. The beams of the car park are accomplished without any use of fire protection material. The most severe fire scenario is a burning car in the middle of the beam (see Figure 1.9.16).

For getting the steel temperature, the natural fire model of a localised fire is used.

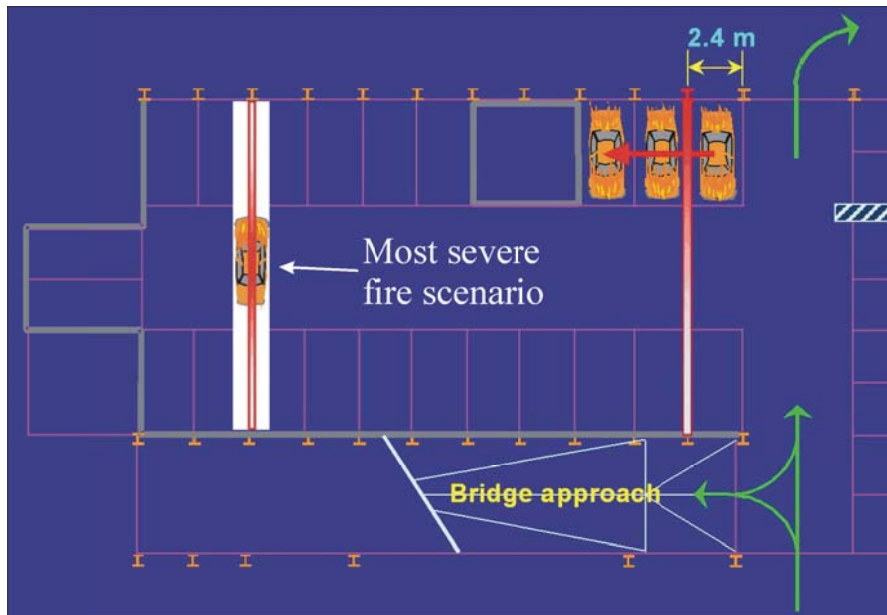


Fig.1.9.16 Underground car park of the shopping mall Auchan

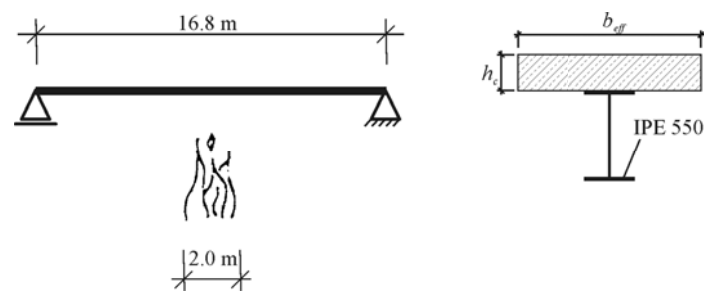


Fig.1.9.17 Static system and cross-section of the beam

- Diameter of the fire:  $D = 2,0 \text{ m}$
- Vertical distance between fire source and ceiling:  $H = 2,7 \text{ m}$
- Horizontal distance between beam and flame axis:  $r = 0$
- Emissivity of the fire:  $\varepsilon_f = 1,0$
- Configuration factor:  $\Phi = 1,0$
- Stephan Boltzmann constant:  $\sigma = 5,56 \cdot 10^{-8} \text{ W/m}^2\text{K}^4$
- Coefficient of the heat transfer:  $\alpha_c = 25,0 \text{ W/m}^2\text{K}$
  
- Steel profile: IPE 550
- Section factor:  $A_m/V = 140 \text{ m}^{-1}$
- Unit mass:  $\rho_a = 7850 \text{ kg/m}^3$
- Surface emissivity:  $\varepsilon_m = 0,7$
- Correction factor:  $k_{sh} = 1,0$

### 1.9.3 Rate of Heat Release

The rate of heat release is normally determined by using the EN 1991-1-2 Section E.4. For dimensioning the beams at this car park, the rate of heat release for one car is taken from an ECSC project called "Development of design rules for steel structures subjected to natural fires in CLOSED CAR PARKS" (see Figure 1.9.18).

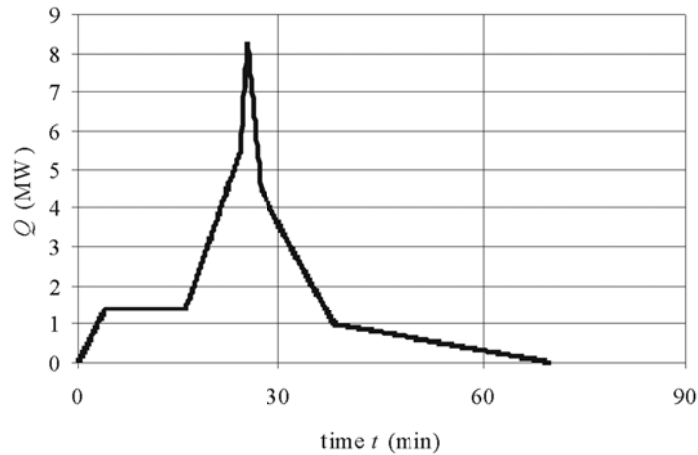


Fig.1.9.18 Rate of heat release of one car

### 1.9.4 Calculation of the steel temperatures

#### Calculation of the flame length

First of all, the flame length has to be determined.

$$L_f = -1,02D + 0,0148Q^{2/5} = -2,04 + 0,0148Q^{2/5}$$

A plot of this function with the values of Figure 1.9.18 is shown in Figure 1.9.19. With a ceiling height of 2,80 m, the flame is impacting the ceiling at a time from 16,9 min to 35,3 min (see Figure 1.9.19).

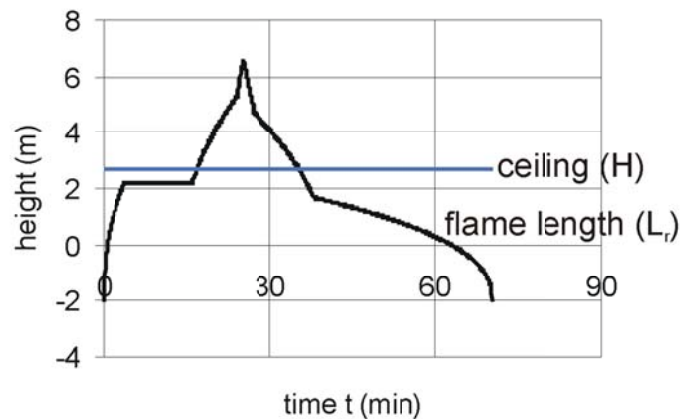
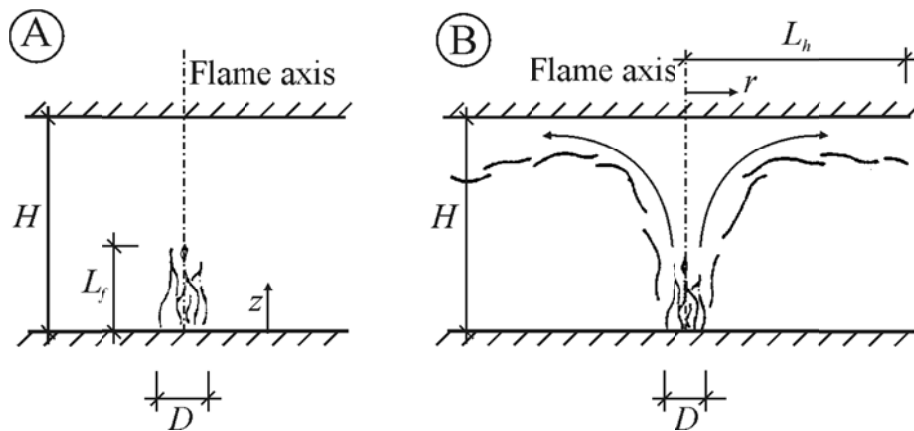


Fig.1.9.19 Flame length of the localised fire



It is important to know, if the flame is impacting the ceiling or not, because different calculation methods for the calculation of the net heat flux are used for these two cases (see Figure 1.9.20).



**Fig.1.9.20** Flame models: Flame is not impacting the ceiling (A); Flame is impacting the ceiling (B)

### Calculation of the net heat flux

#### 1st case: The flame is not impacting the ceiling

The net heat flux is calculated according to Section 3.1 of EN 1991-1-2.

$$\begin{aligned} \dot{h}_{net} &= \alpha_c (\theta_{(z)} - \theta_m) + \Phi \varepsilon_m \varepsilon_f \sigma \left( (\theta_{(z)} + 273)^4 - (\theta_m + 273)^4 \right) = \\ &= 25,0 \cdot (\theta_{(z)} - \theta_m) + 3,892 \cdot 10^{-8} \cdot \left( (\theta_{(z)} + 273)^4 - (\theta_m + 273)^4 \right) \end{aligned}$$

The gas temperature is calculated to:

$$\theta_{(z)} = 20 + 0,25(0,8Q)^{2/3} (z - z_0)^{-5/3} = 20 + 0,25 \cdot (0,8 \cdot Q)^{2/3} \cdot (0,66 - 0,0052 \cdot Q^{2/5})^{-5/3} \leq 900 \text{ } ^\circ\text{C}$$

where:

- z is the height along the flame axis (2,7 m)
- z<sub>0</sub> is the virtual origin of the axis [m]

$$z_0 = -1,02D + 0,0052Q^{2/5} = -2,04 + 0,0052Q^{2/5}$$

#### 2nd case: The flame is impacting the ceiling

The net heat flux, if the flame is impacting the ceiling, is given by:

$$\begin{aligned} \dot{h}_{net} &= \dot{h} - \alpha_c (\theta_m - 20) - \Phi \varepsilon_m \varepsilon_f \sigma \left( (\theta_m + 273)^4 - (293)^4 \right) \\ &= \dot{h} - 25,0 \cdot (\theta_m - 20) - 3,892 \cdot 10^{-8} \cdot \left( (\theta_m + 273)^4 - (293)^4 \right) \end{aligned}$$

The heat flux depends on the parameter y. For different dimensions of y, different equations for determination of the heat flux have to be used.

- if  $y \leq 0,30$ :  $\dot{h} = 100000$

- if  $0,30 < y < 1,0$ :  $\dot{h} = 136300 - 121000y$
- if  $y \geq 1,0$ :  $\dot{h} = 15000y^{-3,7}$

where:

$$y = \frac{r + H + z'}{L_h + H + z'} = \frac{2,7 + z'}{L_h + 2,7 + z'}$$

The horizontal flame length is calculated to:

$$L_h = \left(2,9H(Q_H^*)^{0,33}\right) - H = \left(7,83 \cdot (Q_H^*)^{0,33}\right) - 2,7$$

where:

$$Q_H^* = Q / (1,11 \cdot 10^6 \cdot H^{2,5}) = Q / (1,11 \cdot 10^6 \cdot 2,7^{2,5})$$

The vertical position of the virtual heat source is determined to:

- if  $Q_D^* < 1,0$ :  $z' = 2,4D \left( (Q_D^*)^{2/5} - (Q_D^*)^{2/3} \right) = 4,8 \cdot \left( (Q_D^*)^{2/5} - (Q_D^*)^{2/3} \right)$
- if  $Q_D^* \geq 1,0$ :  $z' = 2,4D \left( 1,0 - (Q_D^*)^{2/5} \right) = 4,8 \cdot \left( 1,0 - (Q_D^*)^{2/5} \right)$

where:

$$Q_D^* = Q / (1,11 \cdot 10^6 \cdot D^{2,5}) = Q / (1,11 \cdot 10^6 \cdot 2,0^{2,5})$$

### Calculation of the steel temperature-time curve

The specific heat of the steel  $c_a$  is needed to calculate the steel temperature. The parameter is given by EN 1993-1-2, Section 3.4.1.2 depending on the steel temperature.

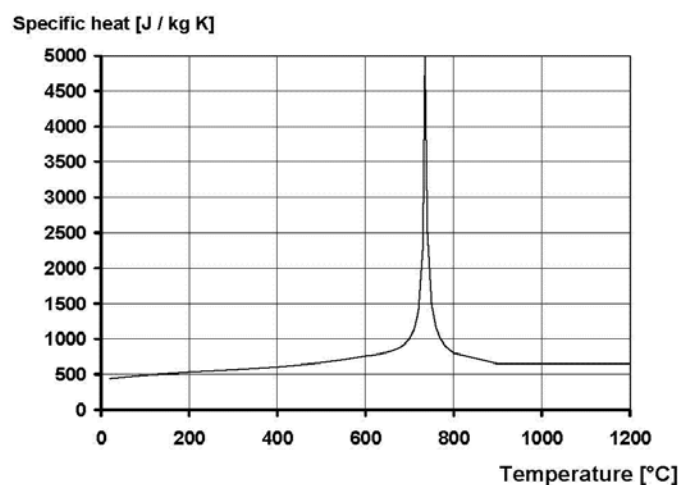
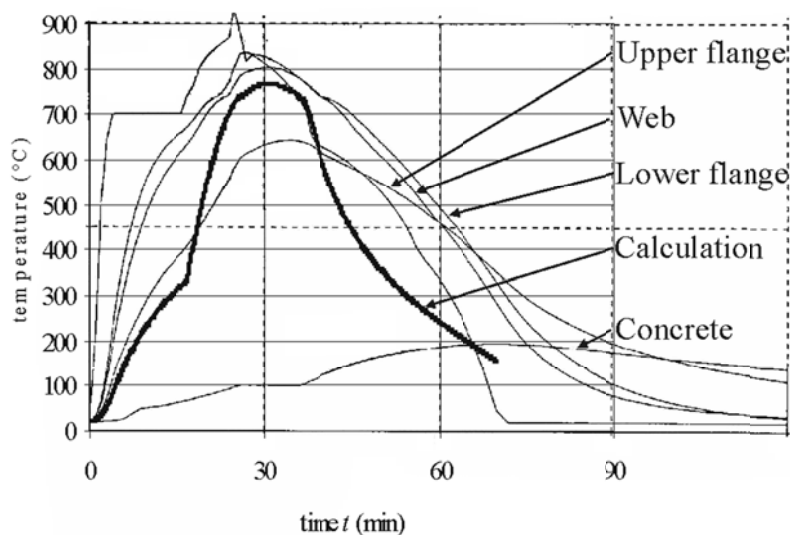


Fig.1.9.21 Specific heat of carbon steel (see EN 1993 Part 1-2, Figure 3.4)

$$\theta_{a,t} = \theta_m + k_{sh} \frac{A_m/V}{c_a \rho_a} \dot{h}_{net} \Delta t = \theta_m + 1,49 \cdot 10^{-4} \cdot \dot{h}_{net}$$

The steel temperature-time curve is shown in Figure 1.9.21. Additionally, the results of the FEM-analysis done by ArcelorMittal are shown for comparison.



**Fig.1.9.22** Comparison of the temperature-time curve of the calculation and the FEM-analysis

### References

- [1] CEN; EN 1991-1-2, Eurocode 1- Actions on structures, Part 1.2-Actions on structures exposed to fire. CEN Central Secretariat, Brussels, November 2002.
- [2] BSI 96/540493 "The use of Fire Safety Engineering in Buildings" (Draft 27 march 1996)
- [3] Initial Fires: Lund University, Sweden. Institute of Fire Safety Engineering. ISSN 1102-8246. ISRN LUTVDG/TVBB--3070--SE. April 1993.
- [4] ARGOS Theory Manuel (draft 5)-Danish Institute of fire technology - 22/07/92
- [5] Peacock, Jones, Bukowski and Forney. NIST Handbook 146, Volume II - Technical Reference Guide for the Hazard I Fire Hazard Assessment Method - Version 1 - June 1991
- [6] Babrauskas Vytenis: "Burning Rates" Section 3/Chapter 1: The SFPE Handbook of Fire Protection Engineering - Second Edition - 13th April 1995
- [7] NKB Committee and Works reports 1994:07E: "Performance and Requirements for Fire Safety and Technical Guide for Verification by Calculation"; Nordic Committee on Building Regulations.
- [8] "Development of design rules for steel structures subjected to natural fires in Large Compartments"; Final report CEC Agreement 7210/ SA210, 317,517,618,832-February 1997.
- [9] Schleich J-B., Cajot L-G., et al.: "Development of design rules for steel structures subjected to natural fires in Closed Car Parks" ECSC Research 7210-SA/211/318/518/620/933; 1993-1996; Final report 1999 – EUR 18867 EN
- [10] CEN; EN 1990, Eurocode – Basis of structural design.

- [11] Schleich J-B., Cajot L-G., et al.: "Competitive steel buildings through natural fire safety concept." ECSC Research 7210-SA/125,126,213,214,323,423,522,623,839,937, 1994-98; Final Report 2002 – EUR 20360 EN.
- [12] Schleich J-B., Cajot L-G., et al.: "Natural fire safety concept –Full scale tests, implementation in the Eurocodes and development of a user-friendly design tool." ECSC Research 7210-060, 1997-2000; Final Report 2003 - EUR 20580 EN..
- [13] Schleich J-B., Cajot L-G., et al.: "Valorisation project - Natural Fire Safety Concept." ECSC Research 7215-PA/PB/PC –042-057, D-E-F-I-NL-UK & ECCS, 1999-2001.
- [14] DD 0000 The Use of Fire Safety Engineering in Buildings. Draft for Approval for Publication; 27. March 96, Technical Committee FSH / 24. 96/540493.
- [15] Fontana M.: "Required Fire Resistance of Building Elements" - Part A: Fire Load in Buildings, Probability Density Function - , NFSC WG4, Zürich, March 1996
- [16] Background document Eurocode 1 (ENV 1991) Part 1: Basis of Design, Working Document N° 94 of ECCS, March 1996.
- [17] Hasemi Y. and Tokunaga Tazo: "Flame Geometry Effects on the Buoyant Plumes from Turbulent Diffusion Flames". Fire Science and Technology, Vol.4, N°1, 1984.
- Ptchelintsev A., Hasemi Y., Nikolaenko M., "Numerical Analysis of Structures exposed to localized Fire", ASIAFLAM's 95, Hong Kong, 1995.
- Wakamatsu T., Hasemi Y., Yokobayashi Y., Ptchelintsev A.: "Experimental Study on the Heating Mechanism of a Steel Beam under Ceiling exposed to a localized Fire".
- Hasemi Y., Yokobayashi Y. , Wakamatsu T., Ptchelintsev A.: "Fire Safety of Building Components Exposed to a Localized Fire"- Scope and Experiments on Ceiling/Beam System Exposed to a Localized Fire, ASIAFLAM's 95, Hong Kong, 1995.
- [18] Hietaniemi J: " Risk-Based Fire Resistance Requirements" ECSC Research 7210-PR-251, 2000-2003
- [19] Kumar S., Welch S., "Natural Fire Safety Concept – The development of a CFD-Based Engineering methodology for evaluating thermal action on steel and composite structures" 7210-PR184, 1999-2002
- [20] iABSE Colloquium: Basis of Design and Actions on Structures; Background and applications of EC 1; delft 1996
- [21] Evaluation du Risque d'Incendie", Méthode de Calcul, Société Suisse des Ingénieurs et des Architectes, documentation n° 81, 1984.
- [22] Thomas P.H.: "Design Guide Structural Fire Safety", Workshop CIB W14, February 1995.
- [23] CEN; EN 1991-2-2, Eurocode 1– Basis of design and actions on structures- Part 2-2: Actions on structures- Actions on structures exposed to fire.
- [24] Cajot L-G, Haller M., et al: "Probabilistic Quantification of a Steel Structure highlighting the potential of steel versus other materials" ECSC Research 7210-PA/PB/PC/PD-249, 2000-2003
- [25] A tool to design steel elements submitted to compartment fires – OZone V2. Part 1: pre- and post-flashover compartment fire model, Cadorin J.-F. & Franssen J.-M., Fire Safety Journal, Elsevier, 38 (2003), 395-427, <http://hdl.handle.net/2268/29650>.
- [26] A tool to design steel elements submitted to compartment fires – OZone V2. Part 2: Methodology and application, Cadorin J.-F., Pintea D., Dotreppe J.-C. & Franssen J.-M., Fire Safety Journal, Elsevier, 38 (2003), 429-451, <http://hdl.handle.net/2268/29651>.

## **CHAPTER 2**

### **FIRE RESISTANCE ASSESSMENT OF STEEL STRUCTURES ACCORDING TO PART 1-2 OF EUROCODE 3 (EN 1993-1-2)**

**Bin ZHAO**

CTICM, France



## 2.1 Introduction

This document aims at helping designers become familiar with the structural fire design of steel building structures according to Eurocode 3 part 1-2. It provides only a general overview of the basic design methods of Eurocode 3 for structural fire design of steel members, for which the following different features are dealt with:

- Fire resistance criteria according to the European standards
- Scope of the fire part of Eurocode 3
- Necessary basic knowledge to apply Eurocode 3 for fire resistance assessment of steel structures
  - Design approaches and design tools
  - Material properties
  - Partial factors
- Design procedure of critical temperature for steel members
- Principle of simple design methods of the fire part of Eurocode 3
- Design recommendations for steel joints in the fire situation
- Application examples of advanced calculation models.

The provided information will allow any designer to get a good understanding about the fundamentals of the fire part of Eurocode 3 to carry out the fire resistance assessment of steel members.

## 2.2 Fire resistance criteria according to the European standards

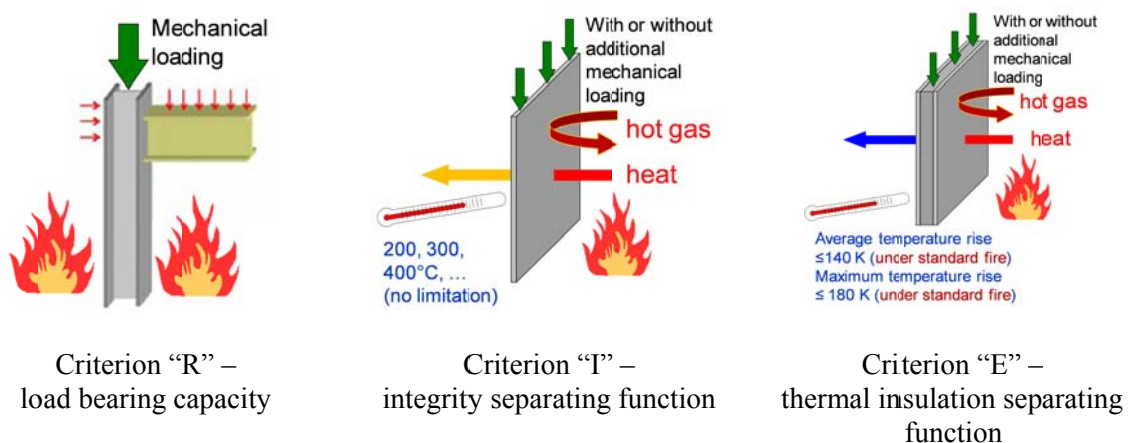
The fire resistance plays an important role to ensure enough safety level of any building in case of fire. According to the European standards, this fire safety functionality is furthermore divided into three criteria on the basis of different safety objectives that a structural member can provide. The definition of above fire resistance criteria are:

- Criterion “R” - load bearing capacity, which is assumed to be satisfied where the load bearing function is maintained during the required time of fire exposure;
- Criterion “E” – integrity separating function;
- Criterion “I” – thermal insulation separating function, which is assumed to be satisfied where the average temperature rise over the whole of the non-exposed surface is limited to a certain level. In case of standard fire, this criterion may be assumed to be satisfied where the average temperature rise over the whole of the non-exposed surface is limited to 140 K, and the maximum temperature rise at any point of that surface does not exceed 180 K.

All above criteria are illustrated in Figure 2.2.1. The criteria “R” and “I” are clearly defined and very easily understandable. However, the integrity criterion “E” is the ability of a separating member of building construction, when exposed to fire on one side, to prevent the passage through it of flames and hot gases and to prevent the occurrence of flames on the unexposed side. The requirements are the following:

- cracks gaps of certain dimensions
- ignition of a cotton wool pad
- sustained flaming on the unexposed side.

Normally the standard fire resistance classification is followed by as a time limit in minutes 15, 30, 45, 60, 90, 120, 180, 240 or 360 which shows the time during which the performance criteria are fulfilled in a standardized fire test.



**Fig.2.2.1** European fire resistance criteria

These criteria may be required individually or combined to provide different fire resistance functions, for example, the following possible fire resistance criteria can be required:

- R30 for a load-bearing structural member
- EI60 for a non-load-bearing separation member
- REI90 for a load-bearing separation member.

## 2.3 Scope of the fire part of Eurocode 3

Various simple design rules are given in the fire part of Eurocode 3 in order to deal with the fire resistance assessment of steel members. However, due to the particularities of steel structures, these rules are only applicable to the load-bearing requirement, that is, the criterion "R".

With the fire part of Eurocode 3, the following steel members can be dealt with:

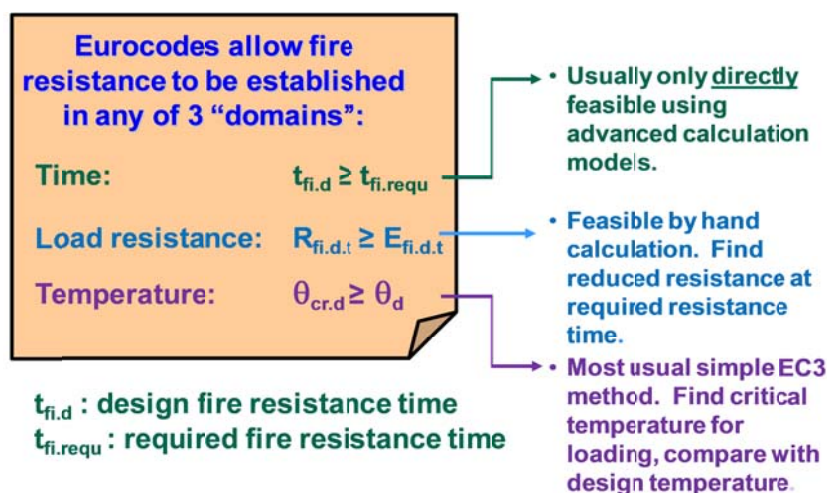
- All types of structural members in carbon steel and the steel grades from S235 up to S460;
- Cold formed structural members complying with EN 1993-1-3
- Material models for five common stainless steel grades
- Heating of both internal and unprotected external steel members.



## 2.4 Necessary basic knowledge to apply Eurocode 3 for fire resistance assessment of steel structures

According to Eurocode 3, the fire resistance of steel building structures can be assessed by means of the following three “domains”:

- in terms of time duration obtained from step by step fire resistance calculation;
- in terms of fire resistance capacity at required resistance time;
- in terms of critical temperature in comparison with the design heating of steel members at required resistance time.



**Fig.2.4.1** Fire resistance assessment of steel structures according to Eurocode 3

The fire resistance of various steel members can be assessed with the help of the fire part of Eurocode 3 but it is necessary to have prior good knowledge of the following fundamental features:

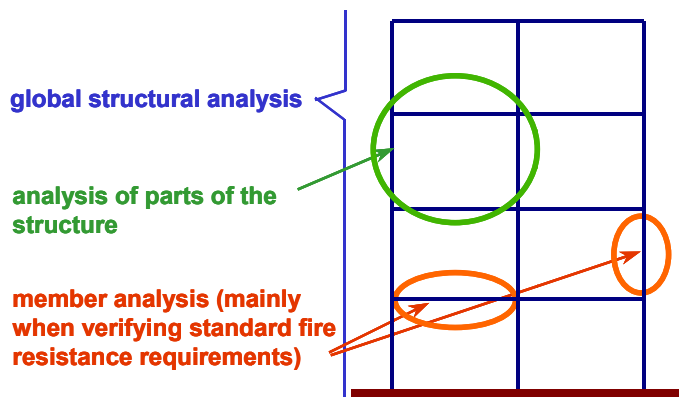
- Design approaches and design tools
- Material properties of steel at elevated temperatures
- Partial factors for fire design of steel structural members.

### 2.4.1 Design approaches and design tools of the fire part of Eurocode 3

Concerning the fire resistance design of steel structures, it can be reached with one of the following three approaches (see also Figure 2.4.2):

- Member analysis, in which each member of the structure will be assessed by considering it fully separated from other members and the connection condition with other members will be replaced by appropriate boundary conditions;
- Analysis of parts of the structure, in which a part of the structure will be directly taken into account in the assessment by using appropriate boundary conditions to reflect its links with other parts of the structure;

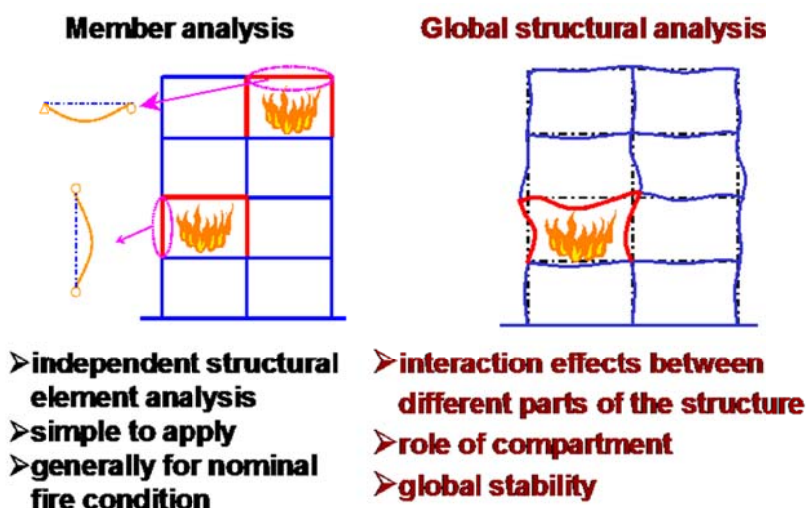
- Global structural analysis, in which the whole structure will be used in the assessment.



**Fig.2.4.2** Different design approaches for mechanical response of structures in fire

Regarding the above mentioned design approaches for assessing the mechanical response of structures in a fire, the following remarks may be made (see also Figure 2.4.3):

- The member analysis will be applied to an isolated structural element (element by element) so it is easy to use in particular with simplified calculation methods and therefore largely used under nominal fire condition (for example: ISO-834 standard fire);
- The analysis of parts of the structure, or global structural analysis, will consider at least several structural members together so that the interaction effect between them will be directly dealt with; load redistribution from heated parts (weakened parts inside fire compartment) to cold parts (stronger parts outside fire compartment) can be taken into account in an accurate way and the global behaviour of structures will be analysed providing therefore a more realistic situation of mechanical response of structures in fire.

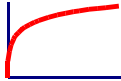


**Fig.2.4.3** Comparison of different design approaches for mechanical response of structures in fire

According to the fire part of Eurocode 3, three types of design methods can be used to assess the mechanical behaviour of steel structures in the fire situation in combination with different design approaches explained above. One can use notably:

- Critical temperature method - this method is the most commonly used simple design rule for fire resistance assessment of steel structural members;
- Simple calculation models - this type of design method comprises all the simple mechanical models developed for steel structural member analysis;
- Advanced calculation models - this kind of design tools can be applied to all types of structures and are in general based on either finite element method or finite difference method. In modern fire safety engineering, it becomes more and more employed design approach due to the numerous advantages that it can provide.

Before going into the detailed explanation of all above design methods, it is extremely important to get a good idea about their application domain. The table given in Figure 2.4.4 shows clearly the different application possibilities of the three fire resistance assessment methods under nominal (standard) fire condition. One can easily find that for member analysis, all three assessment methods may be applied. In very few cases, the simple calculation method can be also applied to the analysis of the mechanical resistance of a part of a steel structure subjected to fire, for example, simple steel portal frames. Therefore, the simple calculation methods are practically limited only to member analysis. Even under nominal fire situations, the structural fire design of complicated structures should be performed in general with the help of advanced calculation models.

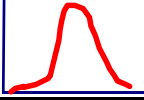
☐ Thermal action defined under standard fire 

Type of analysis	Simple calculation methods	Critical temperature	Advanced calculation models
Member analysis	Yes	Yes	Yes
Analysis of parts of the structure	Not applicable	Not applicable	Yes
Global structural analysis	Not applicable	Not applicable	Yes

**Fig.2.4.4** Application domain of different design methods under standard fire situation

Under natural fire conditions, the application of simple calculation methods is largely limited since the heating behaviour of the member is fully different from that under standard fire condition. That's the reason why the table given in Figure 2.4.5 shows a majority of non-applicable situations of simple calculation methods. The only example in which they can be used is steel members with or without passive fire protection fully engulfed in fire.

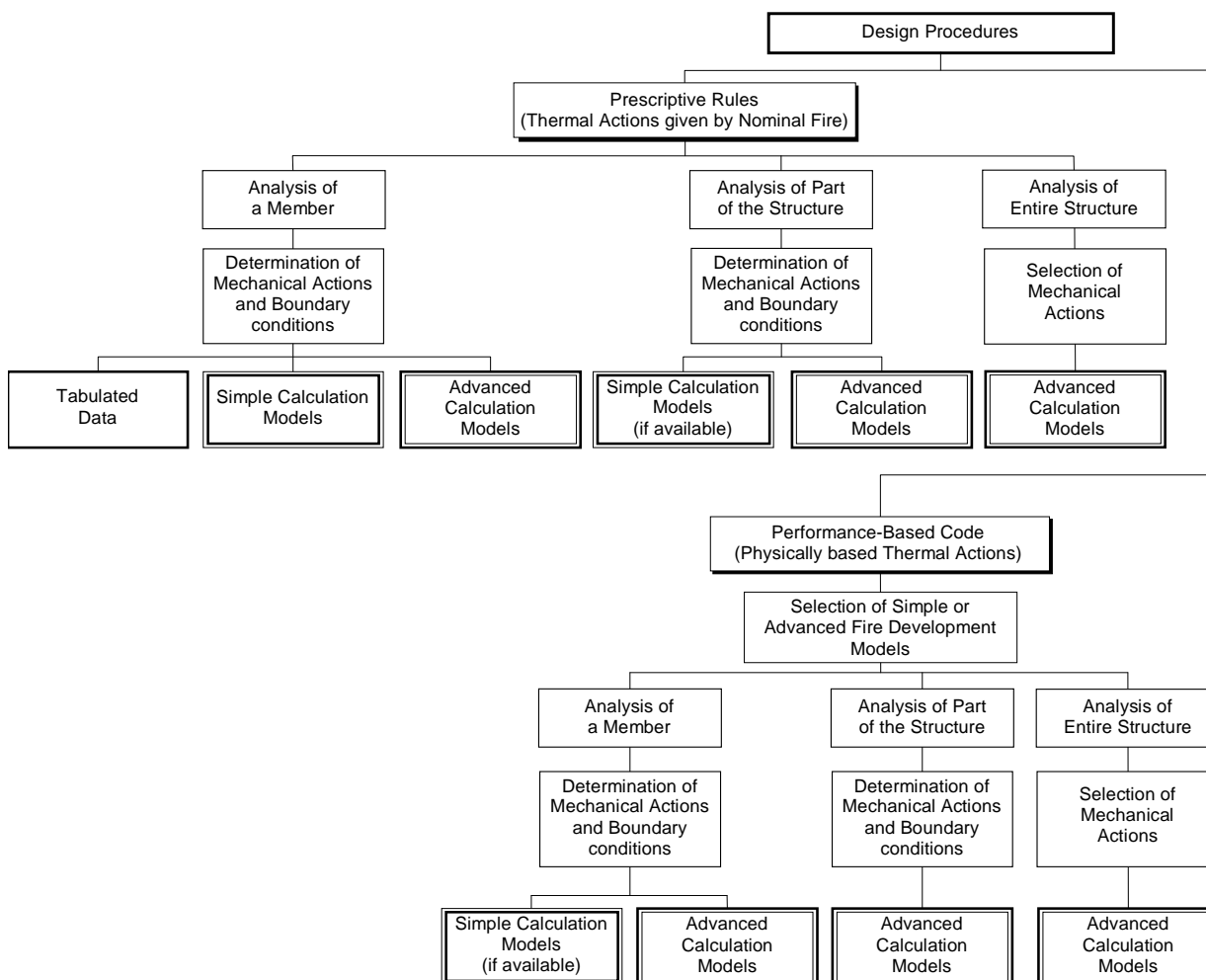
Nevertheless, the application of advanced numerical models in case of natural fire conditions will not be limited due to the fact that they can predict both the accurate thermal response of all structural members subjected to variable thermal actions and the mechanical response of structural members, parts of the structure or the entire structure by taking into account the real material strength and stiffness reduction factors, thermal expansion effect, temperature gradient, etc.

□ Thermal action defined under natural fire


Type of analysis	Simple calculation methods	Critical temperature	Advanced calculation models
Member analysis	Yes (if available)	Yes (if available)	Yes
Analysis of parts of the structure	Not applicable	Not applicable	Yes
Global structural analysis	Not applicable	Not applicable	Yes

**Fig.2.4.5** Application field of different design methods under natural fire situation

All above application procedures and strategy are clearly defined in all Eurocodes fire design parts (see Figure 2.4.6 shown below).



**Fig.2.4.6** Alternative design procedures

## 2.4.2 Material properties of steel at elevated temperatures

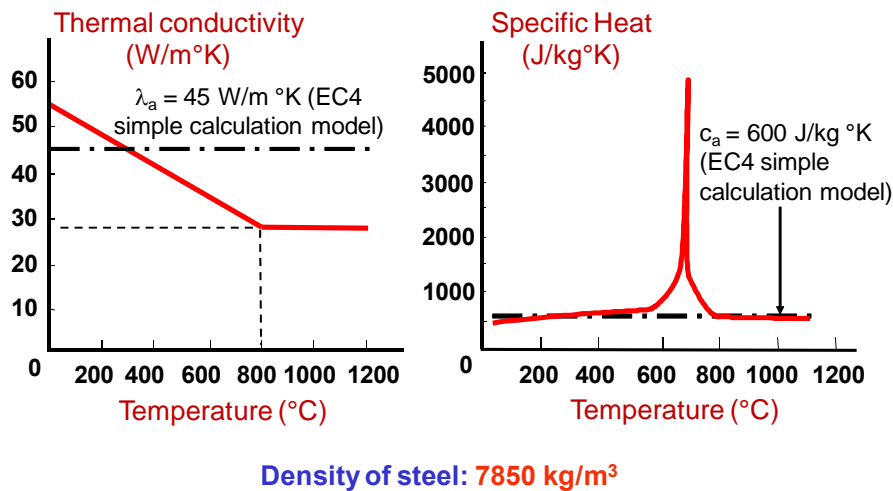
The steel structural fire design needs to deal with two different features, one relative to heating and another one concerning the load-bearing capacity of steel structures. In consequence, two types of material properties are necessary, that are:

- thermal properties of steel as a function of temperature
- mechanical properties of steel at elevated temperatures.

The thermal properties are the thermal conductivity, the specific heat and the density. In case of steel, all these properties are illustrated in Figure 2.4.7.

As it is shown in Figure 2.4.7, the thermal conductivity of steel is quite high and in addition steel members are in general very slender. These factors often lead to a heating very close to uniform one if a steel member is fully engulfed in fire.

All above thermal properties are necessary in the application of simple calculation methods to evaluate the heating of steel members. In order to simplify the calculation cost, constant values can be taken for these properties. However, only the fire part of Eurocode 4 provides these constant values which are also applicable to pure steel members.



**Fig.2.4.7** Thermal conductivity, specific heat and density of steel

The detailed information related to mechanical properties of steel at elevated temperatures is provided in the fire part of Eurocode 3. The strength of steel as function of temperature as well as its stress-strain relationships at elevated temperatures is illustrated in Figure 4-8. One can find that the steel starts to significantly lose strength and stiffness from 400 °C. At 600 °C, its stiffness could be reduced by about 70% and its strength by about 50%.

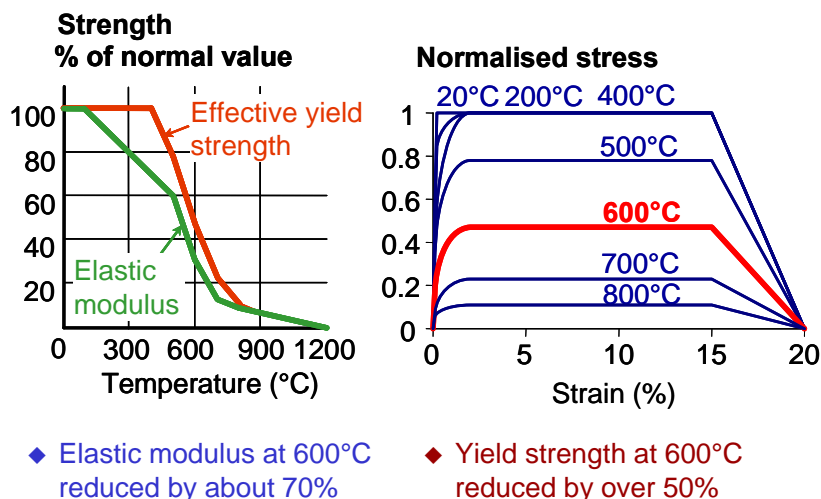


Fig.2.4.8 Mechanical properties of structural steel at elevated temperatures

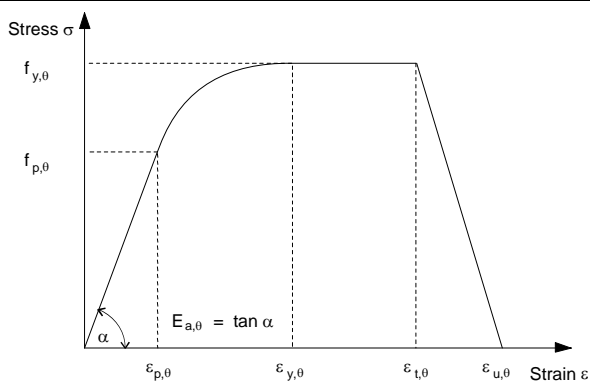
The detailed steel's mechanical properties at elevated temperatures can be obtained using the data given in Table 2.4.1 and Figure 2.4.9 (Table 3.1 and Figure 3.1 of the fire part of Eurocode 3 (EN 1993-1-2)). These data can be used for both simple design rules and advanced calculation models.

Table 2.4.1 Reduction factors for stress-strain relationship of carbon steel at elevated temperatures (Table 3.1 of the fire part of Eurocode 3 (EN 1993-1-2))

Steel temperature $\theta_a$	Reduction factors at temperature $\theta_a$ relative to the value of $f_y$ or $E_a$ at 20 °C		
	Reduction factor (relative to $f_y$ ) for effective yield strength $k_{y,\theta} = f_{y,\theta}/f_y$	Reduction factor (relative to $f_y$ ) for proportional limit $k_{p,\theta} = f_{p,\theta}/f_y$	Reduction factor (relative to $E_a$ ) for the slope of the linear elastic range $k_{E,\theta} = E_{a,\theta}/E_a$
20 °C	1,000	1,000	1,000
100 °C	1,000	1,000	1,000
200 °C	1,000	0,807	0,900
300 °C	1,000	0,613	0,800
400 °C	1,000	0,420	0,700
500 °C	0,780	0,360	0,600
600 °C	0,470	0,180	0,310
700 °C	0,230	0,075	0,130
800 °C	0,110	0,050	0,090
900 °C	0,060	0,0375	0,0675
1000 °C	0,040	0,0250	0,0450
1100 °C	0,020	0,0125	0,0225
1200 °C	0,000	0,0000	0,0000

**NOTE:** For intermediate values of the steel temperature, linear interpolation may be used.

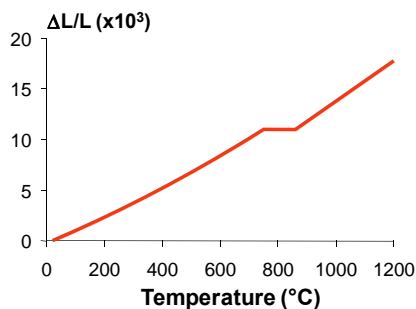
Strain range	Stress $\sigma$	Tangent modulus
$\varepsilon \leq \varepsilon_{p,\theta}$	$\varepsilon E_{a,\theta}$	$E_{a,\theta}$
$\varepsilon_{p,\theta} < \varepsilon < \varepsilon_{y,\theta}$	$f_{p,\theta} - c + (b/a) [a^2 - (\varepsilon_{y,\theta} - \varepsilon)^2]^{0,5}$	$\frac{b(\varepsilon_{y,\theta} - \varepsilon)}{a [a^2 - (\varepsilon_{y,\theta} - \varepsilon)^2]^{0,5}}$
$\varepsilon_{y,\theta} \leq \varepsilon \leq \varepsilon_{t,\theta}$	$f_{y,\theta}$	0
$\varepsilon_{t,\theta} < \varepsilon < \varepsilon_{u,\theta}$	$f_{y,\theta} [1 - (\varepsilon - \varepsilon_{t,\theta}) / (\varepsilon_{u,\theta} - \varepsilon_{t,\theta})]$	-
$\varepsilon = \varepsilon_{u,\theta}$	0,00	-
Parameters	$\varepsilon_{p,\theta} = f_{p,\theta} / E_{a,\theta}$ $\varepsilon_{y,\theta} = 0,02$ $\varepsilon_{t,\theta} = 0,15$ $\varepsilon_{u,\theta} = 0,20$	
Functions	$a^2 = (\varepsilon_{y,\theta} - \varepsilon_{p,\theta})(\varepsilon_{y,\theta} - \varepsilon_{p,\theta} + c / E_{a,\theta})$ $b^2 = c(\varepsilon_{y,\theta} - \varepsilon_{p,\theta})E_{a,\theta} + c^2$ $c = \frac{(f_{y,\theta} - f_{p,\theta})^2}{(\varepsilon_{y,\theta} - \varepsilon_{p,\theta})E_{a,\theta} - 2(f_{y,\theta} - f_{p,\theta})}$	



- Key:**
- $f_{y,\theta}$  effective yield strength;
  - $f_{p,\theta}$  proportional limit;
  - $E_{a,\theta}$  slope of the linear elastic range;
  - $\varepsilon_{p,\theta}$  strain at the proportional limit;
  - $\varepsilon_{y,\theta}$  yield strain;
  - $\varepsilon_{t,\theta}$  limiting strain for yield strength;
  - $\varepsilon_{u,\theta}$  ultimate strain.

**Fig.2.4.9** Stress-strain relationship for carbon steel at elevated temperatures (Figure 3.1 of the fire part of Eurocode 3)

However, the application of advanced calculation models to steel structures needs another property which is the thermal expansion of steel (see Figure 2.4.10).



**Fig.2.4.10** Thermal expansion of steel as function of temperature

### 2.4.3 Partial factors for fire resistance assessment of steel structures

According to Eurocodes, the design values of the mechanical material properties  $X_{fi,d}$  are defined as follows:

$$X_{fi,d} = k_{\theta} X_k / \gamma_{M,fi}$$

where:

- $X_k$  is the characteristic or nominal value of a mechanical material property for normal temperature design;
- $k_{\theta}$  is the reduction factor for a mechanical material property  $X_{fi,d}/X_k$ , dependent on the material temperature, see Chapter 3.2 of the fire part of Eurocode 3;
- $\gamma_{M,fi}$  is the partial factor for the relevant material property, for the fire situation.

In fact, for fire design of steel structures, the partial factors of steel, whatever the type of property is (mechanical or thermal), are all brought to the value of 1,0. Table 2.4.2 compares the partial factors for the yield strength of steel used for both room temperature and fire structural design in Eurocode 3.

**Table 2.4.2** Partial factors for yield strength of steel under the fire situation

Type of members	Ambient temperature design	Fire design
Cross-sections	$\gamma_{M0} = 1,0$	$\gamma_{M,fi} = 1,0$
Members with instability	$\gamma_{M1} = 1,0$	$\gamma_{M,fi} = 1,0$
Tension members to fracture	$\gamma_{M2} = 1,25$	$\gamma_{M,fi} = 1,0$
Joints	$\gamma_{M2} = 1,25$	$\gamma_{M,fi} = 1,0$

## 2.5 Design procedure with critical temperature method

As the most common design method for fire resistance assessment of steel structures remains the critical temperature method, it is very useful for all designers to get an accurate idea about the details of this design method.

In fact, as all other design methods, the application of critical temperature method has to be conducted on the basis of step by step design procedure taking account of all necessary features of Eurocodes for fire design of steel structures. However, the determination of the critical temperature is not the full fire resistance design of steel members and it has to be combined with a calculation of their heating in order to obtain all the necessary results in relation to the fire resistance assessment of steel structures.

The whole design procedure with the critical temperature method will be explained in detail in the following paragraphs.



### 2.5.1 Determination of critical temperatures

The step by step calculation procedure for determination of the critical temperature of a considered steel member can be summarized as follows:

- Step 1: Determination of applied design load to a steel member in the fire situation  $E_{fi,d,t}$ ;
- Step 2: Classification of the steel member under the fire situation;
- Step 3: Calculation of design load-bearing capacity of the steel member at instant 0 of fire  $R_{fi,d,0}$ ;
- Step 4: Determination of degree of utilization of the steel member  $\mu_0$ ;
- Step 5: Calculation of critical temperature of the steel member  $\theta_{cr}$ .

#### 2.5.1.1 Step 1: Determination of applied design load to a steel member in the fire situation $E_{fi,d,t}$

Under the fire situation, the applied loads to structures can be obtained according to the following formula (see relation 6.11b of EN 1990):

$$E_{fi,d,t} = \sum_{j \geq 1} G_{k,j} + (\Psi_{1,1} \text{ or } \Psi_{2,1}) Q_{k,1} + \sum_{i \geq 1} \Psi_{2,i} Q_{k,i}$$

where:

- $G_{k,j}$  are the characteristic values of the permanent actions
- $Q_{k,1}$  is the characteristic leading variable action
- $Q_{k,i}$  are the characteristic values of the accompanying variable actions
- $\Psi_{1,1}$  is the factor for frequent value of a variable action
- $\Psi_{2,i}$  is the factor for quasi-permanent values of the variable actions.

The recommended values of  $\Psi_1$  and  $\Psi_2$  are given in Table 2.5.1 (Table A1.1 of EN 1990) but could be modified in the National Annex.

In the above relation, the recommended combination coefficient of Eurocode for  $Q_{k,1}$  is the  $\Psi_{2,i}$ . But in Europe, the situation is quite different because some Member States have decided to keep the recommended coefficient  $\Psi_{2,i}$  and others have taken  $\Psi_{1,1}$  for  $Q_{k,1}$ . Therefore, the designer has to check the corresponding National Annex for adopted combination coefficient for  $Q_{k,1}$  in his design work.

**Table 2.5.1** Recommended values of  $\psi$  factors for buildings (Table A.1.1 of EN 1990)

Action	$\psi_0$	$\psi_1$	$\psi_2$
Imposed loads in buildings, category (see EN 1991-1-1)			
Category A : domestic, residential areas	0,7	0,5	0,3
Category B : office areas	0,7	0,5	0,3
Category C : congregation areas	0,7	0,7	0,6
Category D : shopping areas	0,7	0,7	0,6
Category E : storage areas	1,0	0,9	0,8
Category F : traffic area, vehicle weight $\leq 30\text{kN}$	0,7	0,7	0,6
Category G : traffic area, $30\text{kN} < \text{vehicle weight} \leq 160\text{kN}$	0,7	0,5	0,3
Category H : roofs	0	0	0
Snow loads on buildings (see EN 1991-1-3)*			
Finland, Iceland, Norway, Sweden	0,70	0,50	0,20
Remainder of CEN Member States, for sites located at altitude $H > 1000$ m a.s.l.	0,70	0,50	0,20
Remainder of CEN Member States, for sites located at altitude $H \leq 1000$ m a.s.l.	0,50	0,20	0
Wind loads on buildings (see EN 1991-1-4)	0,6	0,2	0
Temperature (non-fire) in buildings (see EN 1991-1-5)	0,6	0,5	0
NOTE The $\psi$ values may be set by the National annex. * For countries not mentioned below, see relevant local conditions.			

As a simplification to the accurate calculation above, the applied loads in structural fire design  $E_{d,fi}$  may be obtained from the structural analysis for normal temperature design as:

$$E_{d,fi,t} = \eta_{fi} E_d$$

where

$E_d$  is the design value of the corresponding force or moment for normal temperature design, for a fundamental combination of actions (see EN 1990)

$\eta_{fi}$  is called a “reduction factor” for design loads in the fire situation.

The reduction factor for design loads in the fire situation  $\eta_{fi}$  can be alternatively determined by:

$$\eta_{fi} = \frac{G_k + (\psi_{1,1} \text{ or } \psi_{2,1}) Q_{k,1}}{\gamma_G G_k + \gamma_{Q,1} Q_{k,1}}$$

where

$\gamma_G$  is the partial factor for permanent actions

$\gamma_{Q,1}$  is the partial factor for the leading variable action.

In fact, the reduction factor for design loads in the fire situation  $\eta_{fi}$  depends strongly on the factor  $\psi_{1,1}$  or  $\psi_{2,1}$  which varies as function of building categories (see Table 2.5.1 above). In all fire parts of the Eurocodes, the following figure (Figure 2.5.1) is provided to show clearly the influence of both load ratio  $Q_{k,1}/G_k$  and the factor  $\psi_{1,1}$  on this reduction factor. In addition, Figure 2.5.2 illustrates an accurate case with this reduction factor calculated on the basis of  $\psi_{2,1}$ .

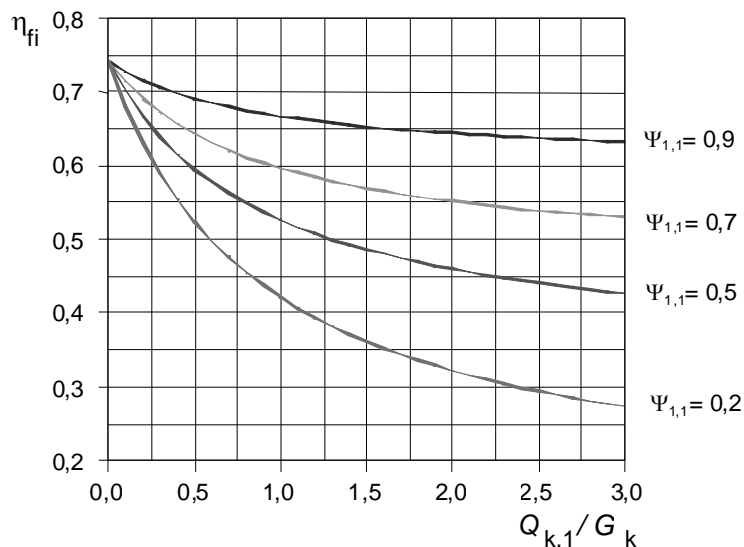


Fig.2.5.1 Variation of the reduction factor  $\eta_{fi}$  with the load ratio  $Q_{k,1}/G_k$

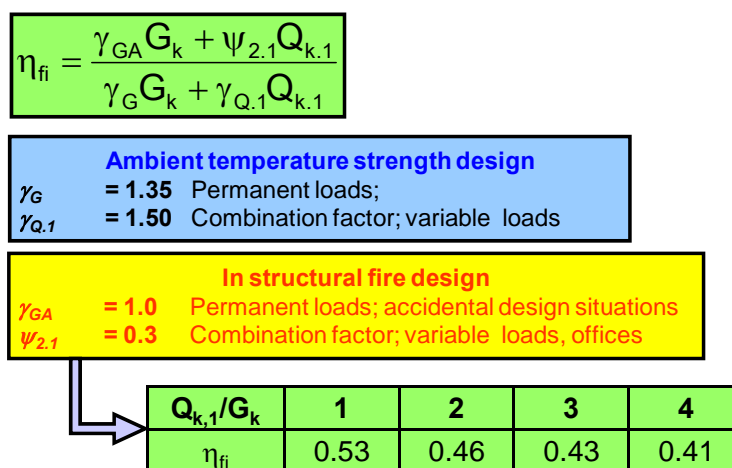


Fig.2.5.2 Variation of the reduction factor  $\eta_{fi}$  with the load ratio  $Q_{k,1}/G_k$  in case of office buildings

However, in the application of Eurocode 3, one should be careful about the difference between this reduction factor and the load level  $\eta_{fi,t}$  of a structural member under the fire situation which is determined as:

$$\eta_{fi,t} = \frac{E_{d,fi}}{R_d}$$

where  $R_d$  is the load-bearing capacity at the ultimate limit state for room temperature design and certainly  $E_d \leq R_d$ .

The value of the load level obtained from above relation is, in general, less important than that of the reduction factor  $\eta_{fi}$ .

It has to be noted that the fire part of Eurocode 3 uses the same symbol for both reduction factor for design loads and the load level of a structural member in the fire situation. The designer needs to be

aware about the difference between them. But in design practice, it is often very convenient to consider simply the reduction factor for design loads of a structural member in the fire situation  $\eta_{fi}$  as its load level in the fire situation  $\eta_{fi,t}$ .

### 2.5.1.2 Step 2: Classification of the steel member under the fire situation

The structural design of steel members needs to take into account the influence of potential local buckling of the walls of steel cross-sections. Eurocode 3 divides the steel members into 4 classes in order to represent the different levels of slenderness of their cross-section. In addition to the slenderness of the section walls, this classification depends on the stress distribution of the cross-section, hence on the loading condition of the member. All detailed design information about this classification is given in part 1-1 of Eurocode 3.

According to Eurocode 3, four classes of rolled shapes characterise the shapes available for structural steel:

- **Class 1: Plastic Design Sections**  
 “Class 1” section can be subjected to a bending moment equal to the plastic moment and, given adequate cross-sectional stiffening, can rotate locally which means a plastic hinge is formed.
- **Class 2: Compact Sections**  
 “Class 2” section can be subjected to a bending moment equal to the plastic moment, however, cannot undergo any local rotation.
- **Class 3: Non-Compact Sections**  
 “Class 3” section can be subjected to a bending moment equal to the yield moment. The cross-section starts buckling after the most outer fibres have yielded.
- **Class 4: Slender Sections**  
 “Class 4” section fails locally before an yield moment can be obtained.

In the fire situation, as the stiffness and the strength of steel vary in different way at elevated temperatures, the risk of local buckling is therefore different and it is necessary to redefine the class of steel member using adapted criterion.

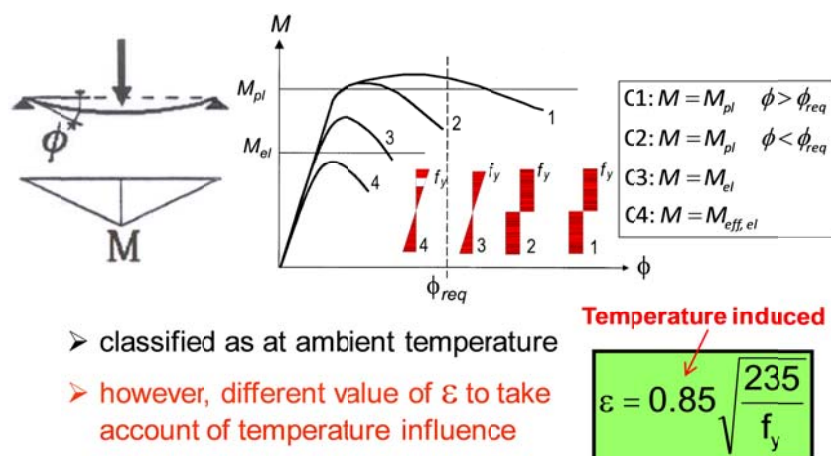


Fig.2.5.3. Classification of the steel member under the fire situation

As it is shown in Figure 2.5.3, a recommended coefficient of 0,85 is given in the fire part of Eurocode 3 to take account of the temperature influence on the classification of steel members in the fire situation and all other parameters of part 1-1 of Eurocode 3 remain unchanged to define the class of any steel member for its fire resistance assessment.

### 2.5.1.3 Step 3: Calculation of design load-bearing capacity of the steel member at instant 0 of fire $R_{fi,d,0}$

The third step is to evaluate the “load-bearing capacity” of steel member under the fire situation, but only at the instant 0, that is, at room temperature. In general, for steel members without any instability phenomenon, such as beams under simple bending, members under tensile force or compressive force with very short length (not subject to buckling), this “load-bearing capacity” is related only to strength of steel and can be derived directly from the load-bearing capacity of the member at ultimate limit state. Nevertheless, for steel members subjected to instability phenomenon, such as columns under flexural buckling, beams with lateral buckling, etc., a specific “load-bearing capacity” should be used so that the critical temperature can be easily obtained. In this case, the “load-bearing capacity” should be either the simple plastic or the elastic resistance of the cross-section (for bending moment or axial force) of the steel member to be investigated. The detailed information about the calculation of this “load-bearing capacity” will be given later in the document.

### 2.5.1.4 Step 4: Determination of degree of utilization of the steel member $\mu_0$

The degree of utilisation  $\mu_0$  is a parameter relating the design load of a steel member in the fire situation to its design load-bearing capacity at instant 0 of fire  $R_{fi,d,0}$ . In case of steel members without instability phenomenon, this parameter can be derived simply from their load level in the fire situation as it is shown in Figure 2.5.4.

The “Degree of Utilisation”

... is the **design loading** of a member in fire,  
 as a proportion of its **design resistance at ambient temperature** ( $t = 0$ ) but including material partial factors for fire design.

$$\mu_0 = \frac{E_{fi,d}}{R_{fi,d,0}}$$

<p><b>A simple version of Degree of Utilisation:</b></p> $\mu_0 = \eta_{fi,t} \left( \frac{\gamma_{M,fi}}{\gamma_{M0}} \right)$	<ul style="list-style-type: none"> <li>* can be used when no risk of overall or lateral-torsional buckling ...</li> <li>* conservative if <math>\eta_{fi,t}</math> calculated as proportion of <b>design loading at ambient temperature</b>.</li> </ul>
---	---

**Fig.2.5.4** Calculation of degree of utilisation

If a steel member is subjected to instability, such as flexural buckling, lateral buckling etc., it is not possible to obtain the critical temperature with the degree of utilization calculated in the way above. In consequence, certain National Annexes have proposed an alternative way to overcome this difficulty on the basis of tabulated data. According to this specific method, the degree of utilization has to be calculated as follows:

- Beams under bending with lateral buckling:

$$\mu_0 = \frac{M_{fi,d,t}}{M_{pl,fi,0}} \quad \text{for beams in Class 1 or 2}$$

$$\mu_0 = \frac{M_{fi,d,t}}{M_{el,fi,0}} \quad \text{for beams in Class 3}$$

with  $M_{fi,d,t}$ ,  $M_{pl,fi,0}$  and  $M_{el,fi,0}$  the design bending moment of the beam, the plastic moment resistance of the cross-section and the elastic moment resistance of the cross-section, respectively, at instant 0 of fire.

- Columns under axial compressive force with flexural buckling:

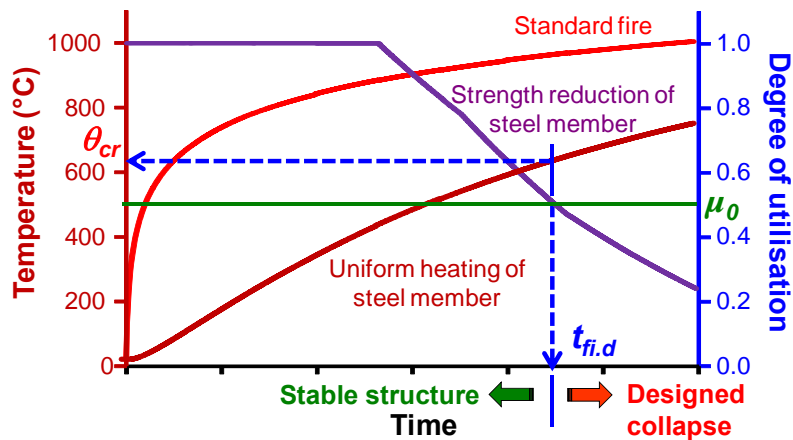
$$\mu_0 = \frac{N_{fi,d,t}}{N_{pl,fi,0}}$$

with  $N_{fi,d,t}$  and  $N_{pl,fi,0}$  the design axial compressive force of the beam and the plastic axial resistance of the cross-section, respectively, at instant 0 of fire.

### 2.5.1.5 Step 5: Calculation of critical temperature of the steel member $\theta_{cr}$

Once the degree of utilisation is determined, it is quite easy to obtain the critical temperature. Once again, it is necessary to make a distinction between steel members without instability phenomenon and those subject to instability.

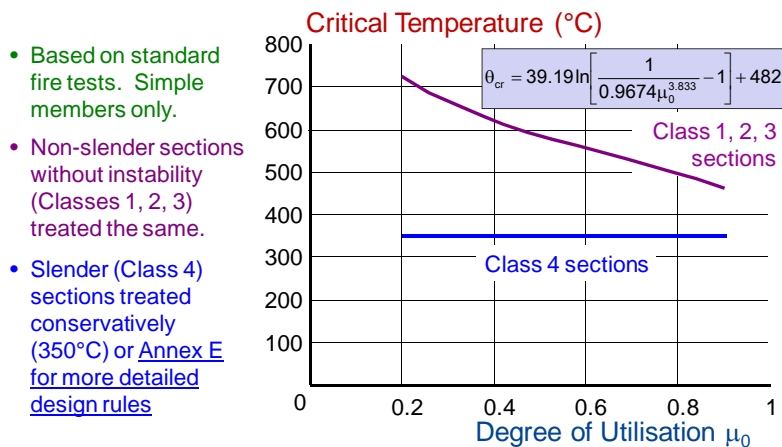
In fact, the mechanical meaning of the critical temperature is illustrated in Figure 2.5.5. This concept is firstly based on the assumption that a steel member is heated uniformly in the fire situation. If it is subjected to a constant degree of utilization  $\mu_0$  and exposed for example to a standard fire it will be heated up progressively, which leads to a gradual decrease of its load-bearing capacity as a function of time. Once the relative reduced strength of the member (relative to its load-bearing capacity at instant 0 of fire) becomes less important than the degree of utilization, its collapse will be inevitable. The heating of the member at the instant its relative reduced strength equals to the degree of utilization is called the “critical temperature” (under uniform heating).



**Fig.2.5.5** Classification of the steel member under the fire situation

- Steel members without any instability phenomenon:

The critical temperature of these members can be obtained according to the description given in Figure 2.5.6 below.



**Fig.2.5.6** Classification of the steel member under the fire situation

- Steel members subjected to instability

The critical temperature of this type of steel members can be obtained directly from the specific tabulated data given in the following tables. It is noted that each steel grade has its own table to define the critical temperature.

In the application of these tabulated data, the following rules need to be respected:

- The non-dimensional slenderness  $\bar{\lambda}_{fi,0}$  of steel columns should be determined with its buckling length in the fire situation. In case of steel columns, its buckling length in the fire situation can be reduced compared to its real length, according to Figure 2.5.7. However, it is necessary to satisfy certain conditions given below:
  - Braced steel structures (with independent bracing system)
  - Continued or laterally end-restrained columns
  - Floor members having at least the same fire resistance R as the columns.

**Table 2.5.2** Critical temperatures of steel members, steel grade S235, based on non-dimensional slenderness in the fire situation and equivalent degree of utilisation

$\bar{\lambda}_{fi,0}$	0,0	0,2	0,4	0,6	0,8	1,0	1,2	1,4	1,6	1,8	2,0
$\mu_0$											
0,04	1000	975	945	906	875	832	783	736	694	677	657
0,06	900	884	863	832	791	751	698	677	654	627	599
0,08	860	837	806	781	743	695	671	644	613	586	561
0,10	820	796	777	747	699	674	645	611	582	554	524
0,12	792	775	752	713	682	653	618	585	555	522	464
0,14	775	755	726	692	665	631	594	563	529	476	357
0,16	758	735	701	678	648	610	576	541	502	394	
0,18	742	714	689	665	631	593	559	520	440		
0,20	725	697	678	651	615	578	541	495	364		
0,22	708	688	667	638	598	564	523	443			
0,24	696	678	655	624	587	549	505	387			
0,26	688	668	644	610	575	535	472				
0,28	679	659	633	598	563	521	432				
0,30	671	649	622	588	552	506	385				
0,32	663	640	610	578	540	483					
0,34	654	630	599	568	528	452					
0,36	646	620	591	559	516	422					
0,38	638	611	583	549	505	382					
0,40	629	601	574	539	486						
0,42	621	593	566	529	464						
0,44	613	586	558	520	441						
0,46	604	579	549	510	418						
0,48	597	571	541	500	387						
0,50	590	564	532	483							
0,52	584	557	524	466							
0,54	577	550	516	449							
0,56	571	542	507	432							
0,58	565	535	498	415							
0,60	558	528	485	391							
0,62	552	520	472								
0,64	545	513	459								
0,66	539	506	445								
0,68	532	497	432								
0,70	526	487	419								

- The non-dimensional slenderness  $\bar{\lambda}_{fi,0}$  of steel beams subjected to lateral torsional buckling should be determined as follows:

- For steel beams with Class 1 or 2 cross-sections  $\bar{\lambda}_{fi,0} = \bar{\lambda}_{LT,20} = \sqrt{\frac{W_{pl} f_y}{M_{cr}}}$

- For steel beams with Class 3 cross-sections  $\bar{\lambda}_{fi,0} = \bar{\lambda}_{LT,20} = \sqrt{\frac{W_{el} f_y}{M_{cr}}}$

where:

$M_{cr}$  is the elastic critical moment for lateral-torsional buckling of the beams at 20 °C

$W_{pl}$  and  $W_{el}$  are the plastic and elastic section modulus of the beams, respectively, at 20 °C.



**Table 2.5.3** Critical temperatures of steel members, steel grade S275, based on non-dimensional slenderness in the fire situation and equivalent degree of utilisation

$\bar{\lambda}_{fi,0}$	0,0	0,2	0,4	0,6	0,8	1,0	1,2	1,4	1,6	1,8	2,0
$\mu_0$											
0,04	1000	979	955	922	888	849	794	750	698	681	662
0,06	900	887	870	845	802	764	709	682	660	634	606
0,08	860	841	817	790	757	702	678	651	621	592	568
0,10	820	798	783	758	713	681	653	620	589	562	532
0,12	792	778	759	727	689	661	628	593	564	531	490
0,14	775	759	736	698	673	642	603	572	539	501	395
0,16	758	739	712	685	658	622	585	552	514	426	
0,18	742	720	694	673	642	602	569	531	472		
0,20	725	700	684	660	627	588	552	511	409		
0,22	708	691	673	647	611	575	536	477			
0,24	696	681	662	635	597	561	519	427			
0,26	688	672	652	622	586	548	503	367			
0,28	679	662	641	609	575	535	468				
0,30	671	653	630	598	564	521	430				
0,32	663	644	619	588	553	508	387				
0,34	654	634	609	579	542	489					
0,36	646	625	599	570	531	460					
0,38	638	616	590	561	520	432					
0,40	629	606	582	552	509	403					
0,42	621	598	574	542	497						
0,44	613	590	566	533	476						
0,46	604	583	558	524	455						
0,48	597	576	550	515	434						
0,50	590	569	542	506	413						
0,52	584	562	534	494	376						
0,54	577	555	526	478							
0,56	571	547	518	462							
0,58	565	540	510	447							
0,60	558	533	502	431							
0,62	552	526	491	415							
0,64	545	519	479	396							
0,66	539	512	466								
0,68	532	504	454								
0,70	526	496	441								

**Table 2.5.4** Critical temperatures of steel members, steel grade S355, based on non-dimensional slenderness in the fire situation and equivalent degree of utilisation

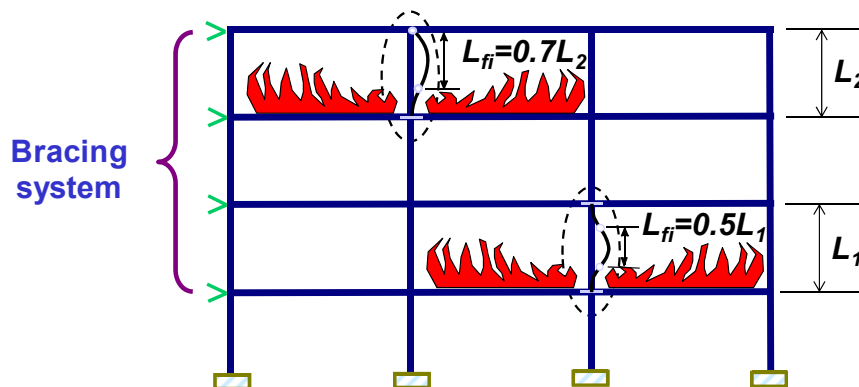
$\lambda_{f,0}$	0,0	0,2	0,4	0,6	0,8	1,0	1,2	1,4	1,6	1,8	2,0
$\mu_0$											
0,04	1000	981	958	928	892	855	799	754	700	683	664
0,06	900	888	873	849	809	769	715	684	662	637	609
0,08	860	843	820	793	762	708	680	654	624	594	570
0,10	820	799	786	762	719	683	656	623	591	564	535
0,12	792	780	762	732	692	664	631	595	567	535	499
0,14	775	760	739	701	676	645	607	575	542	505	407
0,16	758	741	715	688	661	626	589	555	518	437	
0,18	742	721	696	676	646	607	572	535	483	350	
0,20	725	702	686	663	631	592	556	515	422		
0,22	708	692	675	651	616	579	540	489			
0,24	696	682	665	639	601	566	524	441			
0,26	688	673	654	626	590	553	508	388			
0,28	679	664	644	614	579	540	481				
0,30	671	654	633	602	569	527	444				
0,32	663	645	623	592	558	514	407				
0,34	654	636	612	583	547	501					
0,36	646	627	602	574	537	474					
0,38	638	617	593	565	526	446					
0,40	629	608	585	556	515	419					
0,42	621	599	578	547	505	381					
0,44	613	592	570	538	489						
0,46	604	585	562	529	468						
0,48	597	578	554	520	448						
0,50	590	571	546	511	428						
0,52	584	563	538	502	407						
0,54	577	556	530	489	360						
0,56	571	549	522	473							
0,58	565	542	514	458							
0,60	558	535	506	442							
0,62	552	528	498	427							
0,64	545	521	486	412							
0,66	539	514	473	381							
0,68	532	507	461								
0,70	526	499	449								

**Table 2.5.5** Critical temperatures of steel members, steel grade S420, based on non-dimensional slenderness in the fire situation and equivalent degree of utilisation

$\lambda_{fi,0}$	0,0	0,2	0,4	0,6	0,8	1,0	1,2	1,4	1,6	1,8	2,0
$\mu_0$											
0,04	1000	982	960	931	894	859	802	757	701	683	665
0,06	900	889	874	851	812	772	718	685	663	638	610
0,08	860	844	822	794	764	712	681	655	625	595	571
0,10	820	799	787	764	722	685	657	625	592	566	536
0,12	792	780	764	734	693	666	633	597	568	536	502
0,14	775	761	740	704	678	647	609	577	544	507	412
0,16	758	742	717	689	663	628	590	557	520	443	
0,18	742	722	697	677	648	609	574	537	489	358	
0,20	725	703	687	665	633	594	558	518	428		
0,22	708	692	676	653	618	581	543	495	355		
0,24	696	683	666	641	603	568	527	447			
0,26	688	674	656	628	592	555	511	399			
0,28	679	664	645	616	581	542	488				
0,30	671	655	635	604	571	530	451				
0,32	663	646	624	594	560	517	415				
0,34	654	637	614	585	550	504	363				
0,36	646	627	603	576	539	481					
0,38	638	618	595	567	529	454					
0,40	629	609	587	559	519	426					
0,42	621	600	579	550	508	398					
0,44	613	593	571	541	495						
0,46	604	586	563	532	475						
0,48	597	579	556	523	455						
0,50	590	571	548	514	435						
0,52	584	564	540	505	415						
0,54	577	557	532	494	385						
0,56	571	550	524	479							
0,58	565	543	516	464							
0,60	558	536	509	448							
0,62	552	529	501	433							
0,64	545	522	489	418							
0,66	539	515	477	403							
0,68	532	508	465								
0,70	526	501	453								

**Table 2.5.6** Critical temperatures of steel members, steel grade S460, based on non-dimensional slenderness in the fire situation and equivalent degree of utilisation

$\bar{\lambda}_{fi,0}$	0,0	0,2	0,4	0,6	0,8	1,0	1,2	1,4	1,6	1,8	2,0
$\mu o$											
0,04	1000	977	949	913	880	839	787	742	696	678	659
0,06	900	885	866	837	795	756	700	679	656	630	602
0,08	860	839	811	785	749	697	674	647	616	588	564
0,10	820	797	780	752	703	677	648	614	585	557	527
0,12	792	777	755	719	685	656	622	588	559	526	474
0,14	775	757	730	694	668	636	597	567	533	487	373
0,16	758	737	705	681	652	615	580	546	507	408	
0,18	742	717	691	668	636	596	563	524	453		
0,20	725	698	680	655	619	582	545	503	384		
0,22	708	689	669	641	603	568	528	457			
0,24	696	679	658	628	591	554	511	406			
0,26	688	670	647	615	579	540	485				
0,28	679	660	636	602	568	526	446				
0,30	671	651	625	592	557	512	407				
0,32	663	641	614	582	545	496					
0,34	654	632	603	573	534	467					
0,36	646	622	594	563	522	437					
0,38	638	613	586	554	511	408					
0,40	629	603	578	544	499						
0,42	621	595	569	535	477						
0,44	613	588	561	525	455						
0,46	604	581	553	516	433						
0,48	597	573	545	506	411						
0,50	590	566	536	494	367						
0,52	584	559	528	477							
0,54	577	552	520	461							
0,56	571	544	512	444							
0,58	565	537	504	428							
0,60	558	530	493	411							
0,62	552	523	480	375							
0,64	545	515	467								
0,66	539	508	454								
0,68	532	501	441								
0,70	526	490	428								



**Fig.2.5.7** Design buckling length of steel columns in braced steel structures under fire condition

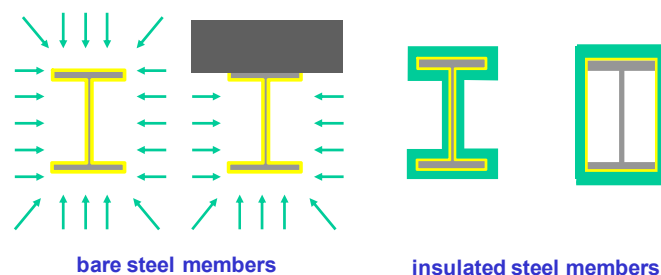
## 2.5.2 Temperature evaluation of unprotected steel members

The calculation of the critical temperature alone does not allow knowing whether the steel member to be investigated has enough fire resistance or not. In fact, it is necessary to get the heating of the steel member after the required fire resistance duration defined by the fire regulation and to compare it with the critical temperature of the steel member to check if it meets the fire resistance condition. Furthermore, the heating of the steel member concerns both the case without any fire protection and the case where the steel member is fire protected.

### 2.5.2.1 Step 6: Calculation of the section factor of unprotected steel members and correction factor for shadow effect

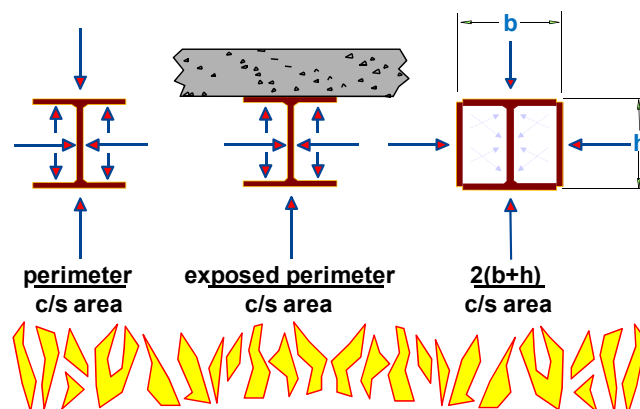
As it is shown in Figure 2.5.8, the section factor is defined as the ratio between the “perimeter through which heat is transferred to steel” and the “steel volume”. In addition, the following (conventional) rules apply:

- for box protection, the steel perimeter is taken equal to the bounding box of the steel profile;
- for steel sections under a concrete slab, the heat exchange between steel and concrete is ignored.



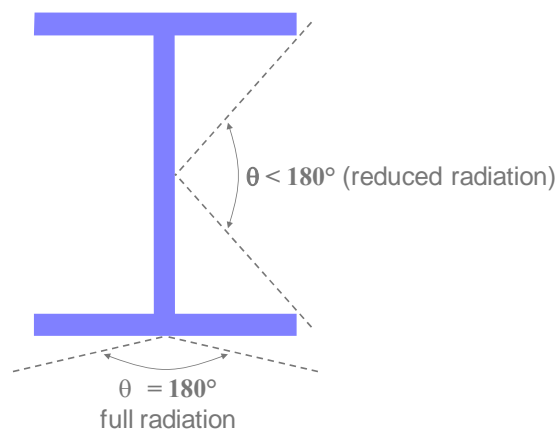
**Fig.2.5.8** Definition of the section factor

In case of an unprotected steel member with a constant cross-section, its section factor can be defined as the exposed perimeter of the cross-section divided by the area of this cross-section (see Figure 2.5.9).



**Fig.2.5.9** Section factor of unprotected steel sections

For heating calculation of unprotected steel sections according to the fire part of Eurocode 3, it is necessary to consider the correction factor  $k_{sh}$ , which is a specific coefficient for the shadow effect (see Figure 2.5.10).



**Fig.2.5.10** Shielding effect for radiation of convex steel sections

It can be shown that for I-shape sections under nominal fire actions the shadow effect is reasonably well described by taking:

$$k_{sh} = 0,9 \left( \frac{A_m}{V} \right)_b / \frac{A_m}{V} \quad \text{where } \left( \frac{A_m}{V} \right)_b \text{ is the box value of the section factor.}$$

In all other cases the value of  $k_{sh}$  shall be taken as:

$$k_{sh} = \left( \frac{A_m}{V} \right)_b / \frac{A_m}{V} .$$

From the above definitions of  $k_{sh}$  follows that for tube profiles, the shadow effect is not activated, since

$$\left( \frac{A_m}{V} \right)_b = \frac{A_m}{V} .$$

### 2.5.2.2 Step 7: Calculation of the heating of unprotected steel members

The increase of the temperature  $\Delta\theta_{a,t}$  in an unprotected steel member during a time interval  $\Delta t$  ( $\leq 5$  seconds) may then be determined from:

$$\Delta\theta_{a,t} = \frac{k_{sh}}{c_a \rho_a} \frac{A_m}{V} h_{net,d} \Delta t$$

where

$k_{sh}$  is the correction factor for the shadow effect

$\dot{h}_{net,d}$  is the design value of the net heat flux per unit area, calculated for bare steel which is composed of two parts, the first one corresponding to convection and the second one being the radiation, that is:

$$\dot{h}_{net,d} = \dot{h}_{net,r} + \dot{h}_{net,c}$$

where

$$\text{Radiation: } \dot{h}_{net,r} = 5,67 \cdot 10^{-8} \phi \varepsilon_{res} \left( (\theta_g + 273)^4 - (\theta_m + 273)^4 \right)$$

$$\text{Convection: } \dot{h}_{net,c} = \alpha_c (\theta_g - \theta_m)$$

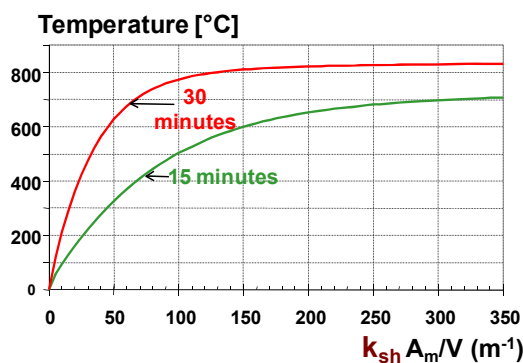
The radiation law of Stephan Boltzmann gives the radiative heat transfer. According to this law, the so-called radiation temperature of the fire environment determines the maximum radiation to the steel element. It can be shown that - by way of conservative approximation - the radiation temperature can be taken equal to the gas temperature and follows from the fire model taken into account. This is the basis of the equation for the net radiative heat transfer specified in the fire part of Eurocode 3. In this equation, the following physical factors play a role:

- Stephan Boltzmann' constant  $\sigma = 5,67 \cdot 10^{-8} \text{ W/m}^2\text{K}^4$  is a physical constant;
- the resultant emissivity of the member  $\varepsilon_{res}$  depends on the material applied in the surface but is always taken equal to 0,7;
- the configuration factor  $\phi$  is a geometrical factor  $\leq 1$ ; for many practical cases (e.g. simulation of standard fire tests) this factor may be taken equal to unity.

Note that the value of the surface temperature  $\theta_m$  for a certain time step follows from the temperature in the preceding time step by solving the corresponding equation.

The net convective heat transfer may be approximated proportional to the temperature difference ( $\theta_g - \theta_m$ ) and is characterized by the coefficient of convection  $\alpha_c$ ; in practice it varies from 25 (standard fire conditions) to 50  $\text{W/m}^2\text{K}$  (hydrocarbon conditions).

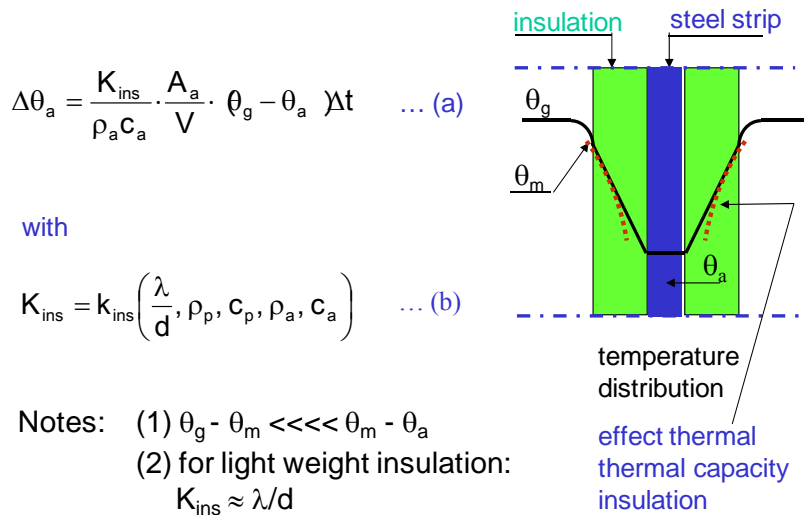
Two curves are provided in Figure 2.5.11 in order to show the heating of unprotected steel sections for 15 and 30 minutes, respectively, of standard fire exposure. It can be found that unprotected steel members may very easily reach a fire resistance of R15, but if a fire resistance of R30 is required it is much more difficult to be met without important over design of the steel member.



**Fig.2.5.11** Heating of unprotected steel section

### 2.5.3 Temperature evaluation of insulated steel members

The procedure to be adopted for calculating the heating of fire protected steel members is very similar to that for unprotected steel members. However, in this case the effect of the insulation has to be taken into account when calculating the net heat flux. In practical situations, the temperature drop over the insulation is relatively large. Consequently, the surface temperature of the insulation is close to the gas temperature. In addition, as the thermal properties to be used for heating calculation of fire protected steel members under standard fire condition are directly derived from fire tests, the shadow effect is already implicitly taken into account. Hence, there is no need to introduce a correction factor  $k_{sh}$  as for bare steel sections. The above is visualised in Figure 2.5.12. Also the basic equations for insulated steel sections are presented in the same figure. As for unprotected steel sections, an overall heat transfer coefficient can be defined (notation:  $K_{ins}$ ). Apparently,  $K_{ins}$  is a function of the thickness of the insulation  $d_p$  and of the thermal properties of both steel ( $\rho_a, c_a$ ) and the insulation material ( $\lambda_p, \rho_p, c_p$ ). If the thermal capacity of the insulation is small, compared to the thermal capacity of the steel,  $K_{ins}$  may be approximated by  $K_{ins} \approx \lambda_p / d_p$ , since under such circumstances a linear temperature distribution over the insulation may be assumed. This is also indicated in Figure 2.5.12.



**Fig.2.5.12** Basic principle of the calculation method for fire protected steel section

The temperature development in a fire protected steel element depends – for given fire conditions in particular under standard fire condition – on two design parameters:

- the section factor  $A_p/V$
- the insulation characteristics  $d_p$  (insulation thickness),  $\lambda_p$  (thermal conductivity),  $\rho_p$  (density),  $c_p$  (specific heat).

#### 2.5.3.1 Step 6a: Calculation of section factor of fire protected steel members

The section factor of a fire protected steel section is taken as the ratio between the inner surface of protection material and the area of the cross section of the steel member. This principle is illustrated in Figure 2.5.13 given below.



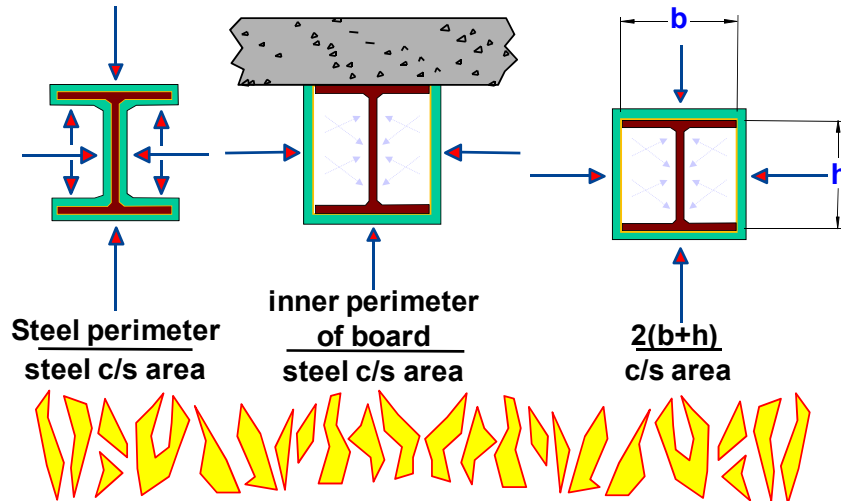


Fig.2.5.13 Section factor of fire protected steel sections

### 2.5.3.2 Step 7a: Calculation of the heating of fire protected steel members

For a uniform temperature distribution in a fire protected cross-section, the temperature increase  $\Delta\theta_{a,t}$  of an insulated steel member during a time interval  $\Delta t$  can be obtained from:

$$\Delta\theta_{a,t} = \frac{\lambda_p / d_p}{c_a \rho_a} \frac{A_p}{V} \left( \frac{1}{1 + \phi / 3} \right) (\theta_{g,t} - \theta_{a,t}) \Delta t - (e^{\phi/10} - 1) \Delta\theta_{g,t} \quad (\text{but } \Delta\theta_{a,t} > 0, \text{ if } \Delta\theta_{g,t} > 0)$$

with

$$\phi = \frac{c_p \rho_p}{c_a \rho_a} d_p \frac{A_p}{V}$$

where:

$A_p/V$  is the section factor of fire protected sections

$\Delta t$  is the time interval of which the value shall not exceed 30 seconds

$\theta_{a,t}$  is the steel temperature at time  $t$  [ $^{\circ}\text{C}$ ]

$\theta_{g,t}$  is the ambient gas temperature at time  $t$  [ $^{\circ}\text{C}$ ]

$\Delta\theta_{a,t}$  is the increase of the ambient gas temperature during the time interval  $\Delta t$  [K].

The simple calculation method above seems quite difficult to apply manually. However, with an Excel calculation sheet, it will be very quick to establish an incremental procedure allowing an accurate estimation of the heating of fire protected steel members.

The common fire insulation systems for steel members are of three types:

- sprays
- boards
- intumescent coatings.

These fire protection systems are shown in Figure 2.5.14. In addition, a comparison is given (in the same figure) to illustrate the efficiency of fire protection applied to steel members.

It should be noted that the thermal properties of the insulation material under the standard fire condition to be used in the simple calculation method above, can be derived from fire tests according to the corresponding European standards.

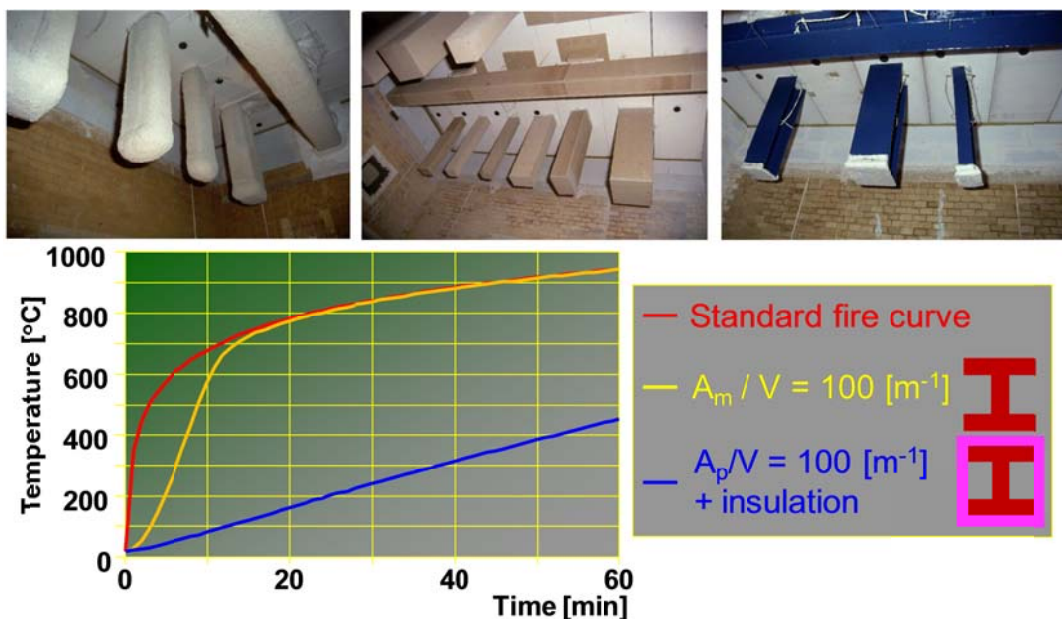


Fig.2.5.14 Examples of three different types of fire protected steel members and heating comparison between bare and fire protected steel members

### 2.5.4 Fire resistance verification of steel members

Once the heating of steel members is determined, the fire resistance of a steel structure can be checked by comparing its critical temperature with its heating obtained at required fire resistance time. This comparison represents the last step of the fire resistance design procedure with the critical temperature. Design procedures for both unprotected steel members and fire protected steel members are shown in Figures 2.5.15 and 2.5.16, respectively.

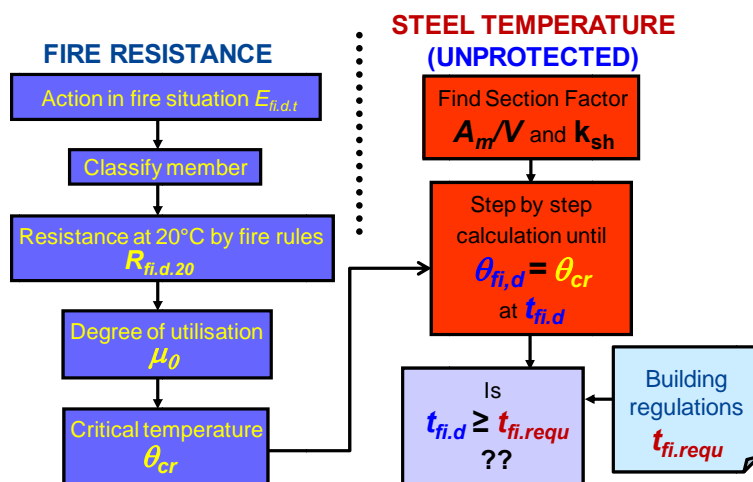
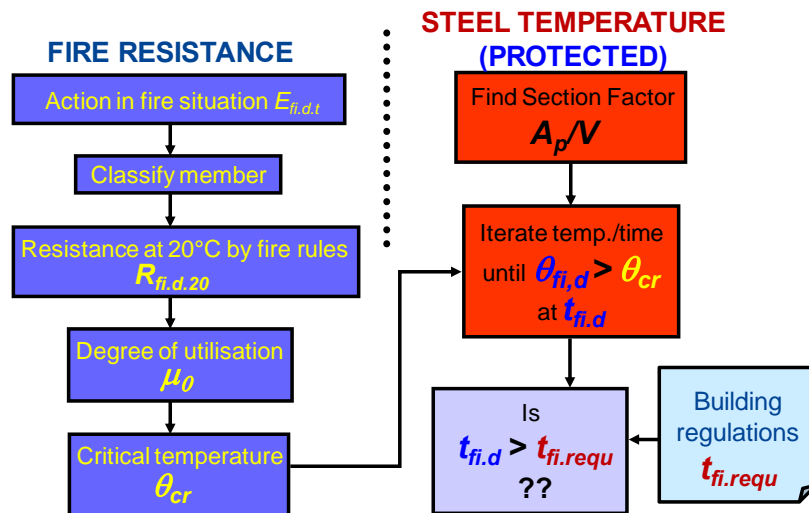


Fig.2.5.15 Full critical temperature design procedure for unprotected steel members



**Fig.2.5.16** Full critical temperature design procedure for fire protected steel members

If the heating of the steel member does not exceed its critical temperature, it means that its fire resistance is not satisfied. In this case, it is necessary either to increase its critical temperature or to reduce its heating for required fire resistance time.

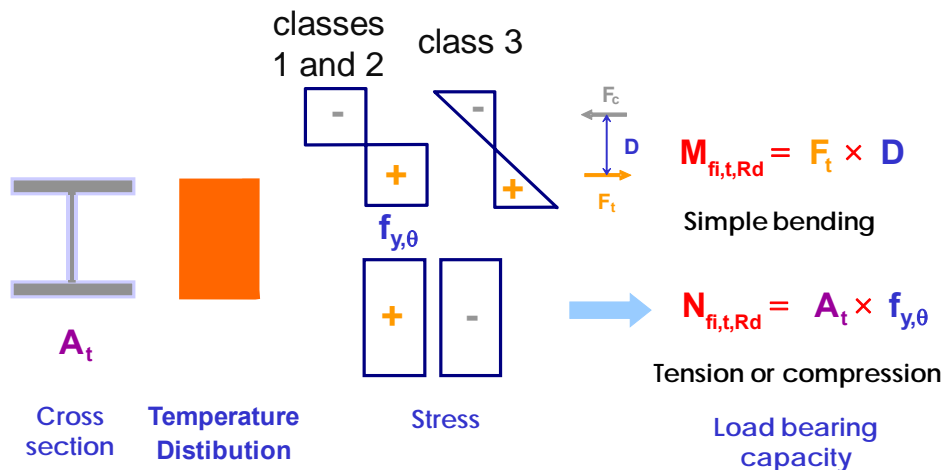
## 2.6 Basic principles of simple calculation methods

The design method with simple calculation models can be divided into the following two families:

- members subjected to either axial force or bending moment without any instability problem - in this case, the simple calculation model is based on the plastic diagram of the cross section at elevated temperatures;
- members under simple axial compression force but implying instability phenomenon, such as axially loaded slender columns - in this case, the simple calculation method is generally based on the buckling curve approach adapted for the fire situation;
- members subjected to combined bending and axial compression, such as slender columns under eccentric load, long beams with lateral buckling, etc. - for this type of members, the simple calculation model takes into account the combination effect of bending and compression by combining the above two models for simple loading condition.

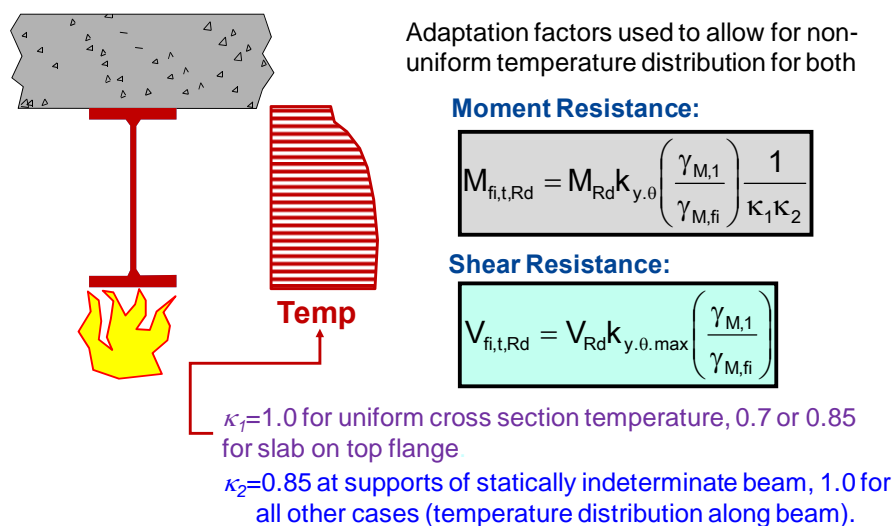
### 2.6.1 Simple calculation methods of steel members without instability

One typical example of first family members is the steel member shown in Figure 2.6.1. The loading condition of the member could be either axial loading or bending. In case of axial loading in compression, the member is supposed to have very small length. According to the simple calculation model, the load-bearing capacity of the steel member can be simply derived from the resistance of the cross section, which is based on a uniform heating and reduced effective strength of steel at this heating level.



**Fig.2.6.1** Design principle of load-bearing capacity of steel members under the fire situation

In general, a uniform heating of steel is considered in the structural fire design of steel members using simple design methods. However, a specific case are the steel beams located below a concrete slab for which a slight temperature gradient exists over its depth (see Figure 2.6.2). In addition, in case of continuous steel beams, the heating of the steel beam at the intermediate supports is also lower than that at the central parts of its spans. According to the fire part of Eurocode 3, these temperature gradients can be taken into account with two parameters,  $\kappa_1$  and  $\kappa_2$ , which are called “adaptation factors”. Particular attention must be paid to the fact that the values of these adaptation factors are different between unprotected and fire protected steel beams (see Figure 2.6.2 for more details about the values of these adaptation factors).



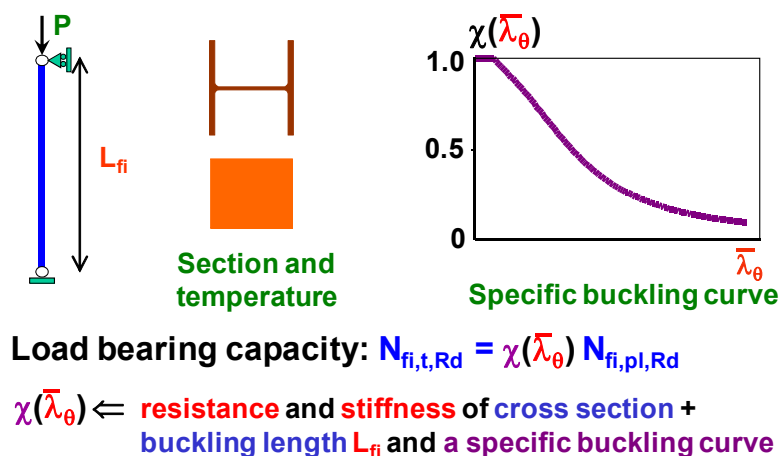
**Fig.2.6.2** Design principle of load-bearing capacity of steel members under the fire situation

## 2.6.2 Simple calculation methods of steel members with instability

Another typical example of simple calculation models is a steel column under axial compressive force (see Figure 2.6.3).

In general, the following points are considered:

- The load-bearing capacity of the column may be simply defined relating the axial plastic section resistance at elevated temperatures  $N_{fi,pl,Rd}$  with the reduction coefficient of the relevant buckling curve  $\chi(\bar{\lambda}_\theta)$ ;
- The reduction coefficient of the relevant buckling curve  $\chi(\bar{\lambda}_\theta)$  for this column depends on the relative slenderness in the fire situation  $\bar{\lambda}_\theta$ , which in turn is related to the axial plastic section resistance  $N_{fi,pl,Rd}$ , the effective rigidity of cross section  $(EI)_{fi}$  and its buckling length  $L_{fi}$  at elevated temperatures.



**Fig.2.6.3** Design principle of load-bearing capacity of steel members under the fire situation

It can be found that in case of members having instability problem, their fire resistance should be evaluated not only on the basis of strength at elevated temperatures but also with stiffness included and for this mechanical reason their critical temperature cannot be derived directly from the simple formula given in Figure 2.5.6.

### 2.6.3 Design recommendations for steel joints

The steel joints are often located at positions where there are concentrations of steel masses so they have less heating than the common parts of the steel members. For this reason, the following specific recommendations can be applied to define their fire resistance:

- The fire resistance of a bolted or a welded joint may be assumed to be sufficient provided that the following conditions are satisfied:
  - The thermal resistance  $(d_f/\lambda_f)_c$  of the joint's fire protection should be equal to or greater than the minimum value of the thermal resistance  $(d_f/\lambda_f)_m$  of the fire protection applied to any of the jointed members;

where:

- $d_f$  is the thickness of the fire protection material ( $d_f=0$  for unprotected members)
- $\lambda_f$  is the effective thermal conductivity of the fire protection material.

- The utilisation of the joint should be equal to or less than the maximum value of utilisation of any of the connected members;
- The resistance of the joint at ambient temperature should satisfy the recommendations given in part 1-8 of EN 1993.

However, if the simple design rules above do not allow checking the fire resistance of steel joints, as an alternative the fire resistance of a joint may be determined using the method given in Annex D of the fire part of Eurocode 3.

#### 2.6.4 Design of external steel structures

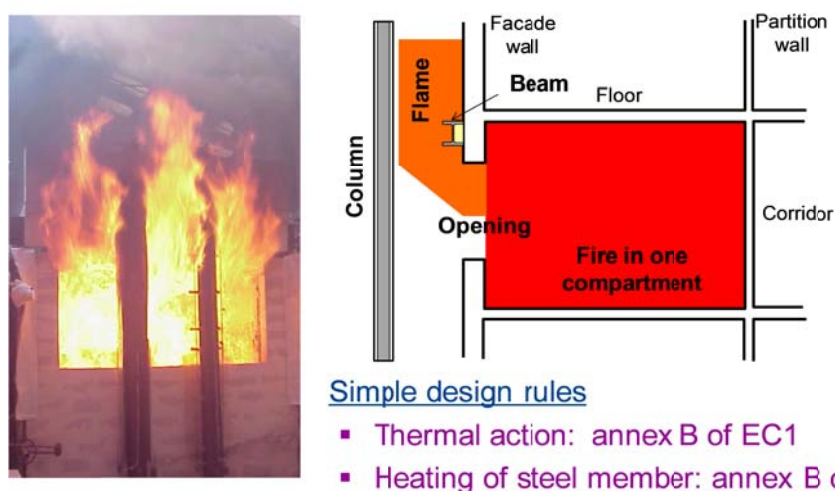
As the external steel members are not located in a confined fire compartment, the thermal actions to these members are less important than those to the internal steel members (see Figure 2.6.4). In fact, the simple calculation method for external structures considers real compartment fires inside the buildings. The external flames through the openings of the building facade, together with the radiation of the internal fires, lead to important thermal actions on the external members.

Hence, according to this method, the temperature of external steelwork should be determined taking into account:

- the radiative heat flux from the fire compartment
- the radiative heat flux and the convective heat flux from the flames emanating from the openings
- the radiative and convective heat loss from the steelwork to the ambient atmosphere
- the size and location of the structural members with respect to the openings.

The heating determination of external steel members needs to combine two annexes of Eurocodes: the first one being the Annex B of the fire part of Eurocode 1 relative to the thermal actions for external members and the second one being the Annex B of the fire part of Eurocode 3 dealing with the heating of external members.

This method provides also the possibility of using heat screens which may be provided on one, two or three sides of an external steel member in order to protect it from radiative heat transfer.



**Fig.2.6.4** Design principle of load-bearing capacity of steel members under the fire situation

Finally, it needs to point out here that the above two annexes are normative, so they can be applied without any National Annex conditions.

## **2.7 Advanced calculation models**

### **2.7.1 Application principles of advanced calculation models**

As far as advanced calculation models are concerned, in principle, they can be applied for any type of structural member analysis in fire design. However, in their practical applications, the following features have to be considered:

- The advanced calculation methods for mechanical response should be based on the acknowledged principles and assumptions of structural mechanics, taking into account the changes of the mechanical properties with the temperature;
- Any potential failure modes uncovered by the advanced calculation method (including local buckling and failure in shear) should be eliminated by appropriate means, for example - in case of numerical analysis using beam elements;
- The advanced calculation methods may be used in association with any heating curve, provided that the material properties are known for the relevant temperature range;
- The effects of thermally induced strains and stresses both due to temperature rise and to temperature differentials, should be considered;
- The model for the mechanical response should also take account of:
  - the combined effects of the mechanical actions, geometrical imperfections and thermal actions
  - the temperature dependent mechanical properties of the material
  - the geometrical non-linear effects
  - the effects of the non-linear material properties, including the unfavourable effects of loading and unloading on the structural stiffness.

### **2.7.2 General application rules of fire design by global structural analysis**

The global structural analysis is more and more employed in the fire safety engineering. As a consequence, the Eurocodes have provided precise rules how to perform this type of analysis. Regarding the analysis of the mechanical response using this approach, the following features should be taken into account:

- First of all, the global structural analysis needs in most cases to use advanced calculation models;
- It is important to choose an appropriate structural modelling strategy (size, type, etc.);
- The existing boundary conditions should be rightly represented;
- The loading condition of the modelled structure must correspond to the situation of fire;

- Material models used in numerical modelling should be representative of real material behaviour at elevated temperatures;
- In case of modelling a part of a structure, the restrained conditions provided by unmodelled parts of the structure should be taken into consideration in an appropriate way;
- It is necessary to provide a deep analysis of the numerical results, from which a detailed check of failure criteria must be performed;
- A review of the features which are not dealt with in the direct analysis shall be made in order to have a consistency between the numerical model and the constructional details.

All the features above will be explained in detail in the following figures showing a real application example of a global structural analysis in a fire safety engineering project.

### 2.7.3 Application requirement of advanced calculation model in global structural analysis of steel structures

For steel structures, the application of the global structural analysis needs to pay attention to following points:

- Regarding the material models, the designer must think of:
  - the strain composition with several strain components at elevated temperatures
  - the kinematical material model for temperature evolution
  - the strength of certain material such as concrete during cooling phase
- The transient heating regime of structures during fire requires the use of a step by step iterative solution procedure rather than a steady state analysis;
- The existing boundary conditions should be rightly represented;
- The loading condition of modelled structure must correspond to that for the fire situation;
- The material models used in the numerical modelling should be representative of real material behaviour at elevated temperatures;
- When doing advanced calculation for fire design of steel structures, designers must be careful with certain specific features, which in general are not taken into account in the direct modelling, such as the joint resistance, etc.

#### 2.7.3.1 Strain composition of material model in advanced numerical modelling

In advanced numerical modelling for a global structural analysis of steel and composite structures, it has to be kept in mind that the strain of any element exposed to fire is composed of several components that may be explicitly expressed using following relation (see Figure 2.7.1):

$$\varepsilon_t = \varepsilon_{th} + (\varepsilon_\sigma + \varepsilon_c + \varepsilon_{tr}) + \varepsilon_r$$

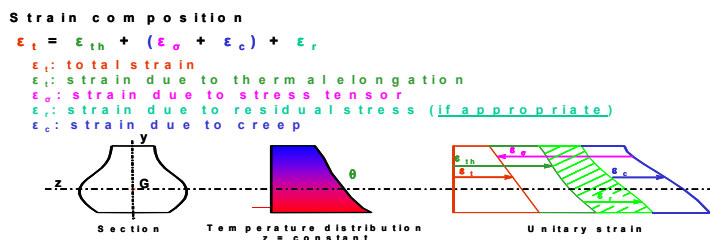
where:

- $\varepsilon_t$  is the total strain
- $\varepsilon_{th}$  is the strain due to thermal elongations
- $\varepsilon_\sigma$  is the strain due to stresses



- $\epsilon_c$  is the strain due to creep effects at elevated temperatures
- $\epsilon_{tr}$  is the strain due to transient and non-uniform heating regimes for concrete
- $\epsilon_r$  is the strain due to residual stresses, often present in steel

According to Eurocode 3, the creep strain of steel is considered to be included implicitly in the stress-strain relationships of the corresponding material at elevated temperatures. In addition, the residual stress is in general also neglected except for some special structural analysis.

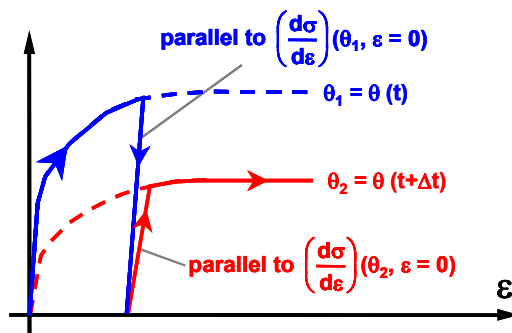


**Fig.2.7.1** Strain composition of material model in advanced numerical modelling

### 2.7.3.2 Kinematical material model for taking into account of temperature evolution

Under the fire situation, the temperature field of structural members varies with time. On the other hand, all material mechanical properties are more or less temperature dependant. In consequence, during a fire, the materials of a structure will behave in such a way that their properties change constantly. This type of material behaviour has to be taken into account appropriately in the advanced calculation models by the so-called kinematical material model. As far as steel is concerned, the kinematical rules to be applied are shown in Figure 2.7.2.

For steel, the shift from one stress-strain curve to another, due to the change of temperature, shall be made by staying at a constant plastic strain value between two temperature levels. This shift rule remains available under any stress state of steel (tension or compression).



**Fig.2.7.2** Kinematical material model for taking into account the temperature evolution

Normally, such type of material model is already implemented in all relevant advanced calculation models for fire safety engineering application. However, it is important for designers to know how to use these material models in their practical application.

### 2.7.3.3 Principle of step by step iterative solution procedure in advanced numerical calculation

In general, the structural analysis under the fire situation is based on ultimate limit state analysis which means to establish the equilibrium between its resistance and the applied loading on the structure for various heating states. However, an important displacement of the structure will occur inevitably due to both material softening and thermal expansion leading to large material plastification. Therefore, the advanced fire analysis is no longer linear-elastic but elasto-plastic in which both the strength and the stiffness behave non-linearly. From mathematical point of view, the solution of such analysis cannot be obtained directly and has to use the following specific procedure (see Figure 2.7.3):

- Step by step analysis in order to get the equilibrium state of the structure at various instants, hence different temperature fields;
- Within each time step, an iterative solution procedure is necessary to find out the equilibrium state of the structure behaving in an elasto-plastic way.

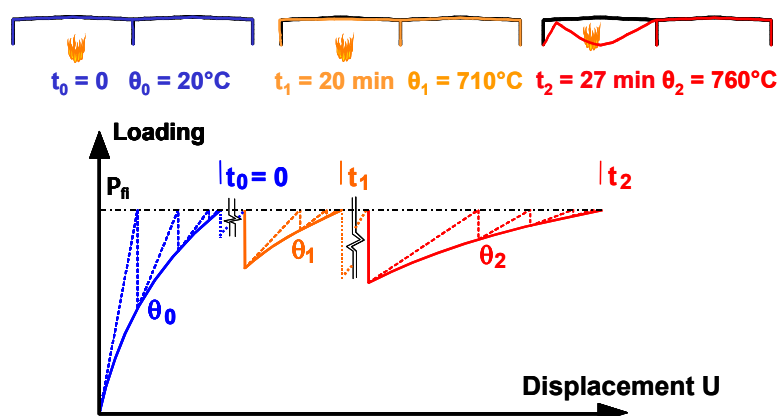
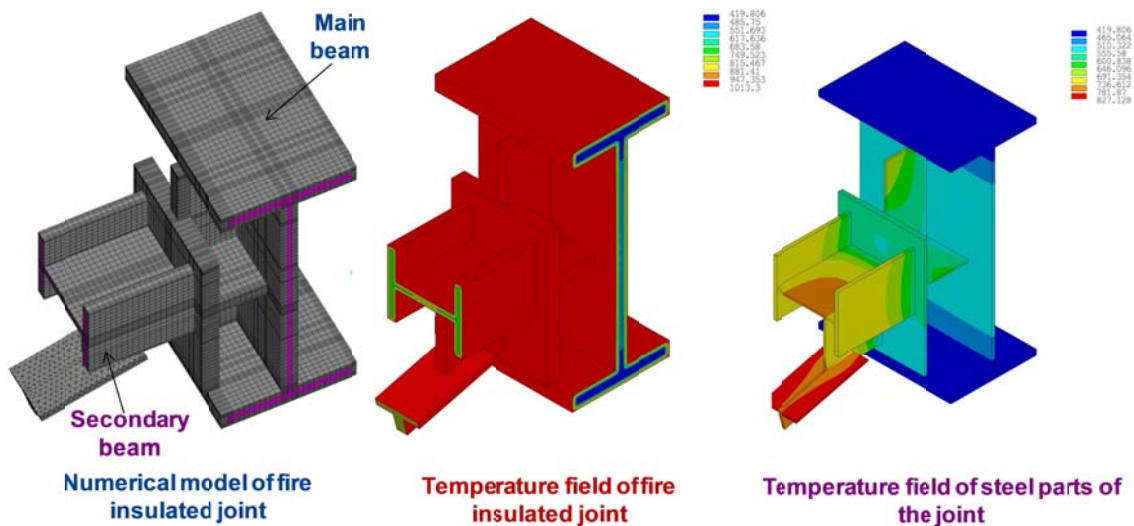


Fig.2.7.3 Principle of step by step iterative procedure in advanced numerical calculation

### 2.7.4 APPLICATION EXAMPLES OF ADVANCED CALCULATION MODELLING OF STEEL STRUCTURES

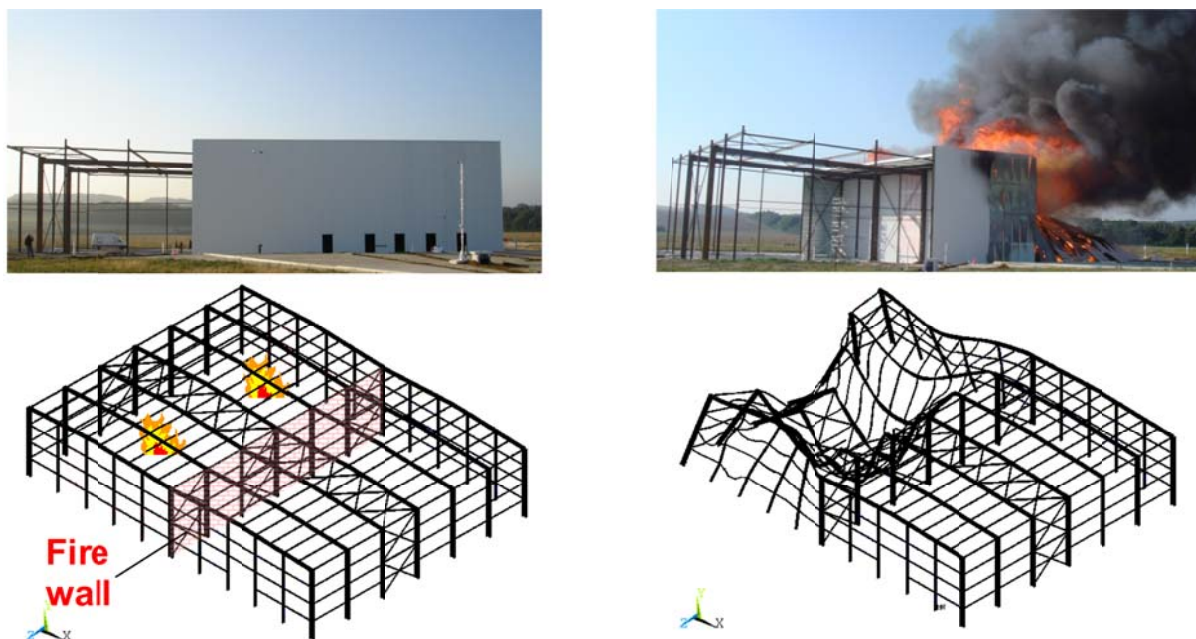
Two examples are provided to show the potential possibilities of the advanced calculation modelling, dealing with the fire resistance of steel structures.

The first example corresponds to an advanced calculation relative to the heating of the joint between two steel members with different thicknesses of the protection (see Figure 2.7.4) after a fire exposure of 90 minutes under the standard fire condition. In this example, the main beam is designed to have much lower critical temperature than the secondary beam. Hence, the heating of the secondary beam will be much higher once exposed to fire. The question arises then about the heating of the main beam when the secondary beam is connected to it. Considering the complexity of the joint configuration, it is necessary to conduct an advanced calculation to check whether the important heating of the secondary beam will lead to an excessive heating of the main beam or not.



**Fig.2.7.4** Design principle of load-bearing capacity of steel members under the fire situation

The second example concerns the failure mode of a warehouse with unprotected steel structure separated with a fire wall between the two compartments (see Figure 2.7.5). This is a typical case to show the full advantages of the advanced calculation models compared to the simple calculation methods because the latter cannot deal with this situation at all. In addition, the results of the advanced calculation model are clearly validated against the fire test.



**Fig.2.7.5** Design principle of load-bearing capacity of steel members under the fire situation

## 2.8 Worked examples

### 2.8.1 Description of the steel building

The building selected for the worked examples is an office building having six levels. Its global dimensions are summarized below:

- Length: 30 meters
- Width: 14 meters
- Height of each storey: 3,4 meters including a net height of 2,5 meters, the technical level, the depth of steel beams and slab, the ceiling and the lighting systems
- Total height:  $6 \times 3,4 = 20,4$  meters.

The lift and the staircase are designed to be located at the centre part of the building and the remaining parts of the floor are organized as an open space office area with meeting rooms having flexible locations.

The roof is considered to be accessible for persons working in the buildings.

The fire resistance requirement for this building structure is R60.

#### 2.8.1.1 Steel structure's arrangement

The steel structure (see the 3D view illustrated in Figure 2.8.1) is designed with three rows of columns along the length of the building. Along the length direction, the spacing of these columns is 6 meters and along the width direction their spacing is 7 meters.

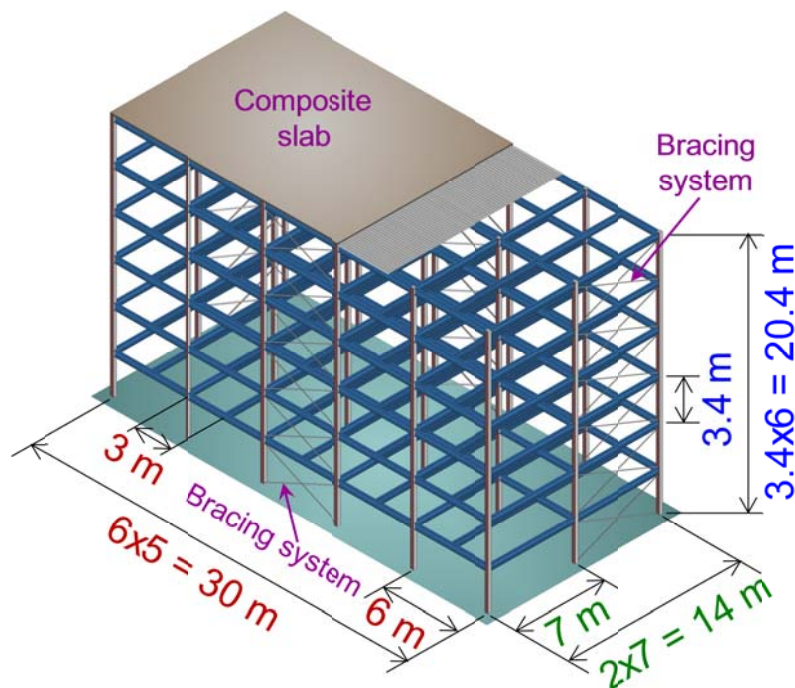
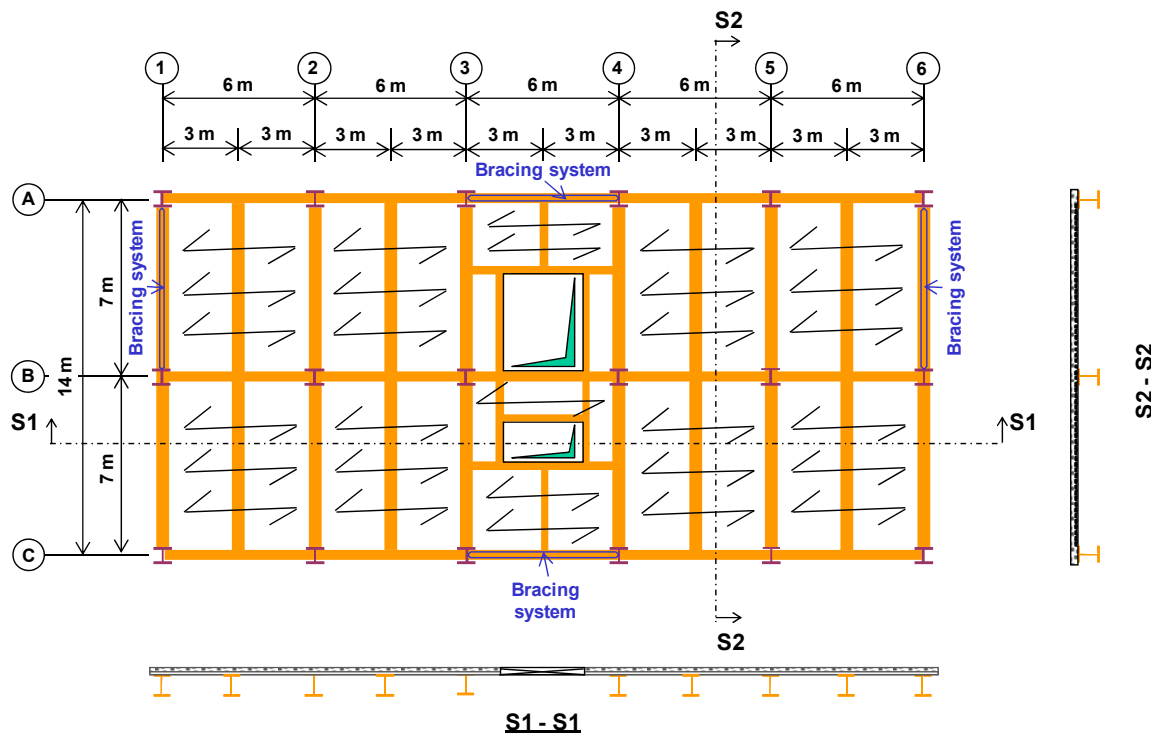


Fig.2.8.1 3D view of steel structure

The main beams have an equal span of 6 meters. The secondary beams have an equal span of 7 meters with a spacing of 3 meters, which is also the span of the slab.

The slab is designed as a composite slab with steel decking COFRAPLUS60 of 120 mm total depth. The length of the steel deck is 6,0 meters with two equal spans of 3 meters each (see Figure 3.1.1 for more details).

The structure is braced with four bracings located in the centre and at the end parts of the building (see Figure 2.8.2). The wind force transfer to the bracings is considered to be ensured by the diaphragm effect of the composite slab.



**Fig.2.8.2** Plan view of the floor structure

### 2.8.1.2 Loading conditions

The design loads for this structure are:

- Permanent load on the floor:
  - Self-weight of the slab:  $g_{p,k} = 2,12 \text{ kN/m}^2$
  - Other permanent loads:  $g_{o,k} = 1,5 \text{ kN/m}^2$
- Permanent load of the facade:  $g_{f,k} = 2,0 \text{ kN/m}$
- Variable load on floor:  $q_{v,k} = 4,0 \text{ kN/m}^2$
- Snow load on the roof:  $q_{n,k} = 1,7 \text{ kN/m}^2$ .

It must be noted that the above loads do not include the self-weight of the steel structural members, such as beams, columns, bracings etc.

### 2.8.1.3 Material properties

To simplify the design and construction, the same steel grade S275 is used for all steel members.

### 2.8.2 General

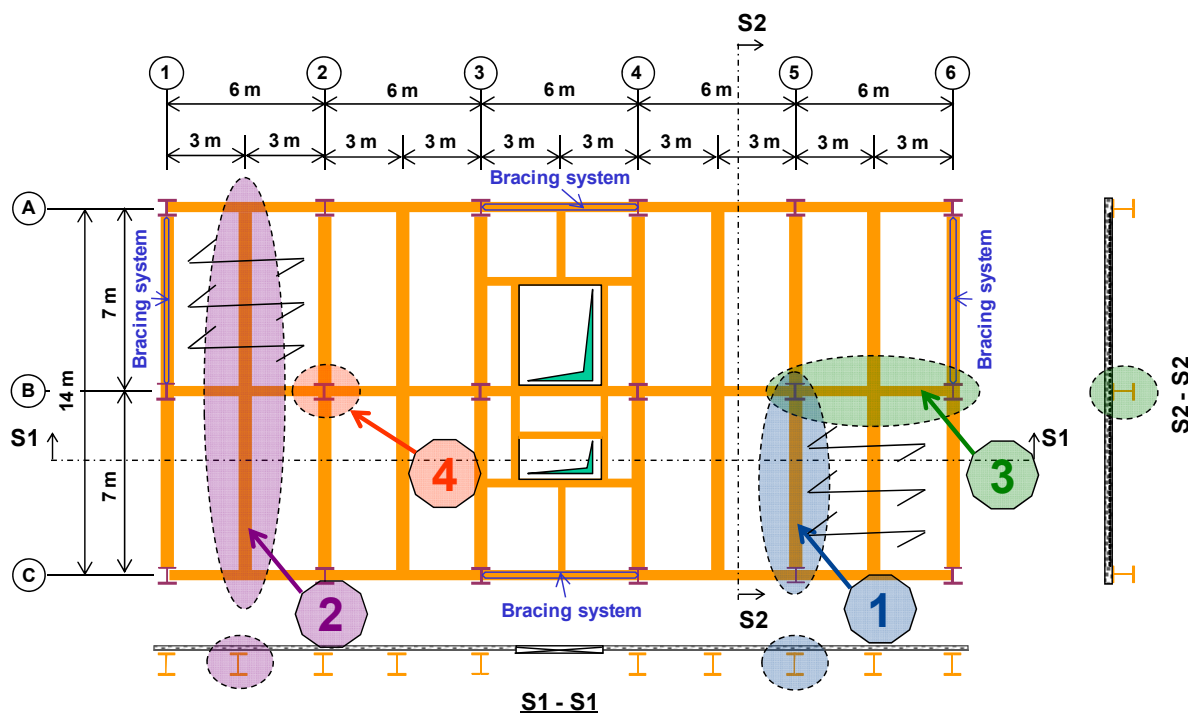
For this building, the whole design will involve a number of structural members, most of them repeatable in the terms of the calculation procedure. For this reason, only four structural members are selected for the worked examples in order to illustrate the application of the fire part of Eurocode 3 for fire resistance assessment of steel structures. The readers can use the same calculation procedure to deal with all other structural members.

As it is explained earlier, the composite slab is designed as two-span continuous slab, the structural fire design of which is described in details in the worked examples to Eurocode 4 (Chapter 3). Taking this into account, the selected four examples are (see Figure 2.8.3 and Figure 3.1.1):

1. Simply supported secondary beams under the end supports of the continuous slabs;
2. Continuous secondary beam under the central supports of the continuous slabs;
3. Simply supported central main beams;
4. Central columns at the ground floor.

It needs to be pointed out, that due to the important load from the central supports of the continuous slabs, it is decided to use continuous secondary beams under all central supports of the two-span slabs.

All above mentioned members selected for the worked examples are shown in Figure 2.8.3.

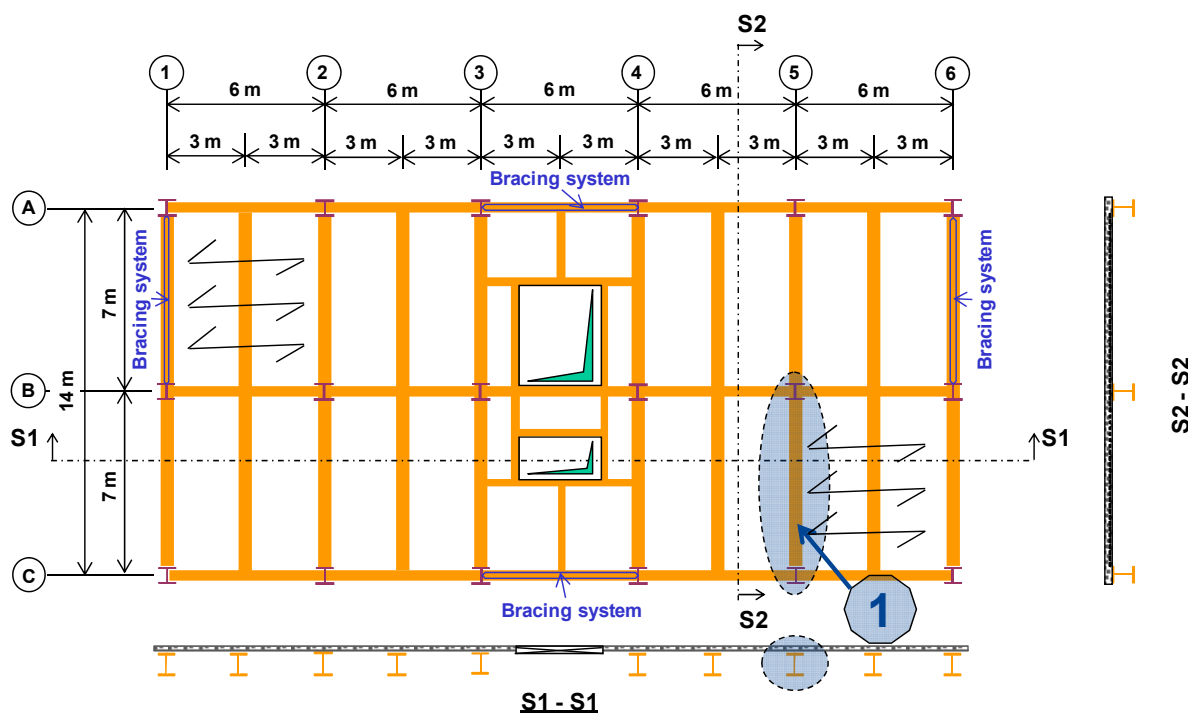


**Fig.2.8.3** Location of the structural members selected for the worked examples

The critical temperature method will be applied in detail to explain how to use this very common method for structural fire design of steel members. A step by step procedure will be adopted to deal with the fire resistance design of the above mentioned four steel members.

### 2.8.3 Example 1: Simply supported secondary beam under the end support of the continuous slab

The first worked example concerns the secondary beams under the end supports of the two-span continuous slabs (see Figure 2.8.4).



**Fig.2.8.4** Location of the selected steel beam for the first worked example

#### 2.8.3.1 Step 1: Design loads in the fire situation

The loads applied to this beam come mainly from the slab over it. Due to the fact that the slab is designed as a two-span continuous slab, the reaction forces are different at the three supports. From the static structural analysis, these forces can be determined using the following relations:

- end support:  $0,375q_s l$
- central support:  $1,25q_s l$

where:

- $q_s$  corresponds to the applied load on the slab per square meter
- $l$  is the span of the slab.

Considering that one beam should support, in general, two end supports of the slabs above it, the load applied to the supporting beam at this position should be  $0,75q_s l$ .

For the fire resistance design of this beam, it is necessary to select the relevant loads to be used for the variable actions which include live load, wind and snow actions. In the case of this beam, the influence of the wind load can be neglected. As regards the live load and the snow, there are two combination possibilities, the first one with live load as leading variable action and the snow as accompanying variable action and the second one with the snow as leading variable action and the live load as accompanying variable action. According to relation 6.11b and Table A1.1 of Eurocode 0 (EN 1990), if the recommended values are adopted for the leading variable action, that is  $\Psi_{2,1}$ , the following relation can be established:

$$E_{fi,d,t} = \sum_{i \geq 1} G_{k,j} + \Psi_{2,1} Q_{k,1} + \sum_{i \geq 1} \Psi_{2,i} Q_{k,i}$$

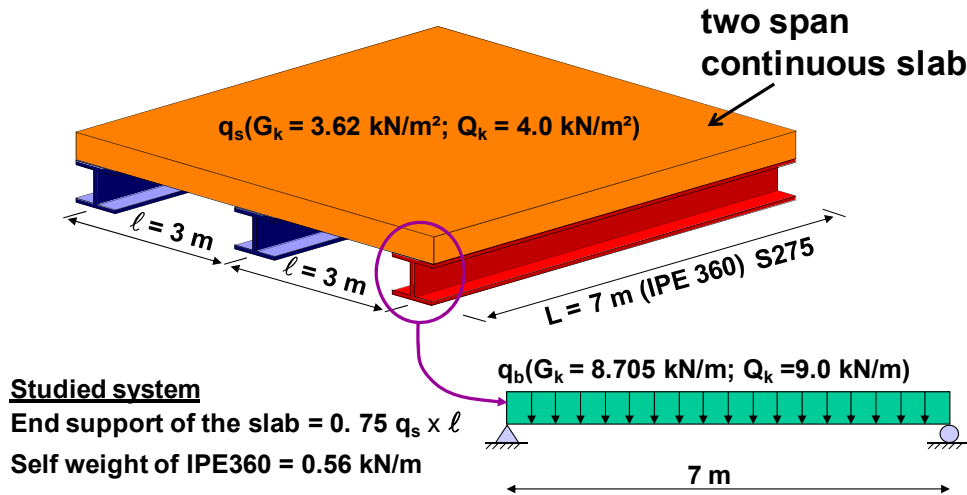
It can be found that in this case, all variable actions will take the combination coefficient  $\Psi_{2,i}$  which will lead to only one possible combination due to the fact that the value of  $\Psi_{2,i}$  for the snow action equals to 0. In consequence, the design load in the fire situation on the slab can be expressed simply as:

$$q_{fi,d,t,s} = \sum_{i \geq 1} G_{k,j} + 0,6Q_{k,1} = g_{p,k} + g_{o,k} + 0,6q_{v,k} = 2,12 + 1,50 + 0,6 \cdot 4,0 = 6,02 \text{ kN/m}^2$$

In the fire situation, the design load of the beam IPE360, which self-weight is  $G_b=0,56 \text{ kN/m}$ , can be obtained as follows:

$$q_{fi,d,t} = G_b + 0,75 \left( \sum_{i \geq 1} G_{k,j} + 0,6Q_{k,1} \right) l = G_b + 0,75q_{fi,d,t,s} l \approx 14,105 \text{ kN/m}$$

This calculation is also clearly illustrated in Figure 2.8.5 given below.



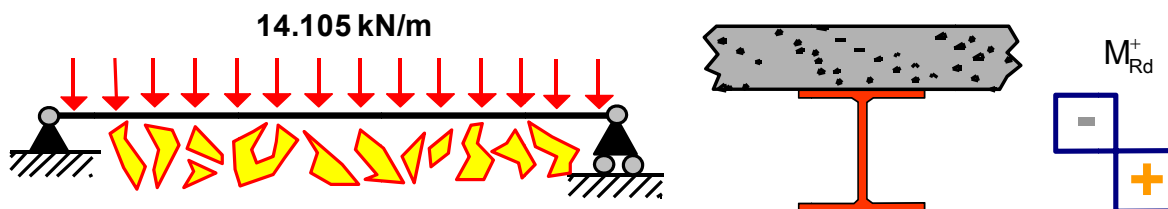
**Fig.2.8.5** Loading condition of the selected steel beam in the fire situation

The loading condition of this beam is shown in Figure 2.8.6.

For this beam, the applied load in the fire situation leads to the following maximum internal forces:



- bending moment:  $M_{fi,d,t} = \frac{q_{fi,d,t} L^2}{8} = 86,4 \text{ kNm}$
- vertical shear:  $V_{fi,d,t} = \frac{q_{fi,d,t} L}{2} = 49,4 \text{ kN}$



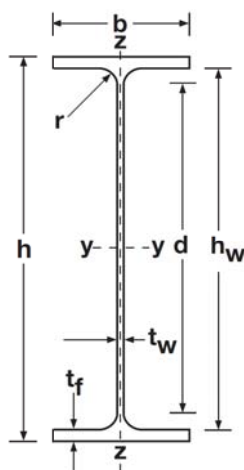
**Fig.2.8.6** Applied load on the selected steel beam in the fire situation

### 2.8.3.2 Step 2: Classification of the steel beam

The classification of this beam should be made by combining the Table 5.2 of Eurocode 3, part 1-1 (EN 1993-1-1) and the relation 4.2 of the fire part of Eurocode 3 (EN 1993-1-2). The two wall elements of the cross section, that are the flange and the web, have to be checked.

The dimensions of IPE360 are summarized below (see Figure 2.8.7):

$$H = 300 \text{ mm} \quad B = 150 \text{ mm} \quad t_w = 7,1 \text{ mm} \quad t_f = 10,7 \text{ mm} \quad r = 15 \text{ mm} \quad h_w = 278,6 \text{ mm} \quad d = 248,6 \text{ mm}$$



**Fig.2.8.7** Dimension notation of I or H shape steel profile

According to relation 4.2 of the fire part of Eurocode 3 (EN 1993-1-2):

$$\varepsilon = 0,85 \sqrt{235/f_y} = 0,786 \quad \text{with steel grade S275}$$

On the other hand, according to Table 5.2 of Eurocode 3, part 1-1, the criteria of Class 1 for the flange and web are:

- web:  $c/t_w \leq 72\varepsilon \Rightarrow c/t_w \leq 72\varepsilon \Rightarrow d/t_w \leq 72\varepsilon = 56,6$
- flange:  $c/t_f \leq 9\varepsilon \Rightarrow (B/2 - t_w/2 - r)/t_f \leq 9\varepsilon = 7,07$

with the dimensions given above, there are:

- web:  $d/t_w = 248,6/7,1 = 37,3 < 56,6$
- flange:  $(B/2 - t_w/2 - r)/t_f = (150/2 - 7,1/2 - 15)/10,2 = 4,96 < 7,07$

The beam is then classified as Class 1 and it can develop full plastic moment resistance.

### 2.8.3.3 Step 3: Determination of the design resistance of the steel beam at room temperature

As the load-bearing capacity of the beam depends on two parameters, the bending moment and the vertical shear, it is necessary to take them into account in the fire resistance design of the beam. The ultimate moment and vertical shear resistances of this beam may be obtained on the basis of §6.2.5 and §6.2.6 of Eurocode 3 part 1-1 (EN 1993-1-1).

- From relation 6.13 of Eurocode 3 part 1-1:

$$M_{Rd} = M_{pl,Rd} = \frac{W_{pl,y} f_y}{\gamma_{M0}} = \frac{1019 \cdot 10^3 \cdot 275}{1,0} = 280,3 \text{ kNm}$$

- From relation 6.18 of Eurocode 3 part 1-1:

$$V_{Rd} = V_{pl,Rd} = \frac{A_v (f_y / \sqrt{3})}{\gamma_{M0}} = \frac{3514 \cdot (275 / \sqrt{3})}{1,0} = 557,9 \text{ kN}$$

### 2.8.3.4 Step 4a: Degree of utilisation of the unprotected steel beam

From the relation 4.24 of the fire part of Eurocode 3, there are:

- With respect to the bending moment:

$$\mu_{0,M} = \eta_{fi,M} \frac{\gamma_{M0}}{\gamma_{M,fi}} = \frac{M_{fi,d,t}}{M_{Rd}} \frac{\gamma_{M0}}{\gamma_{M,fi}} = \frac{86,4}{280,3} \cdot \frac{1,0}{1,0} = 0,308$$

- With respect to the vertical shear:

$$\mu_{0,V} = \eta_{fi,V} \frac{\gamma_{M0}}{\gamma_{M,fi}} = \frac{V_{fi,d,t}}{V_{Rd}} \frac{\gamma_{M0}}{\gamma_{M,fi}} = \frac{49,4}{557,9} \cdot \frac{1,0}{1,0} = 0,088$$

As the beam supports the concrete slab above, the impact of the kappa factors relative to the temperature gradient over its depth have to be taken into account. However, they have impact only on the bending moment because no rule is provided to the vertical shear. In addition, as the kappa factors are different for unprotected and fire protected beams, two degrees of utilisation may be obtained. In case of unprotected beams, their four faces must be considered exposed, due to the fact that the composite slab does not cover more than 85 % of the upper face of the upper flange of the beam (see

clause 16 of section 4.1 of the fire part of Eurocode 4). Hence, there are  $k_1=1,0$  and  $k_2=1,0$  (for simply supported beams).

In consequence:

- The modified degree of utilisation for the bending moment (on the basis of relation 4.10 of the fire part of Eurocode 3) is:

$$\mu_{0,M,\kappa} = \mu_{0,M} (\kappa_1 \kappa_2) = 0,308 \cdot (1,0 \cdot 1,0) = 0,308$$

- The modified degree of utilisation for the vertical shear is:

$$\mu_{0,V,\kappa} = \mu_{0,V} = 0,088$$

The final value of the degree of utilisation should be determined as follows:

$$\mu_0 = \max(\mu_{0,M,\kappa}; \mu_{0,V,\kappa}) = \max(0,308; 0,088) = 0,308$$

### 2.8.3.5 Step 5a: Calculation of the critical temperature of the unprotected beam

The critical temperature of the beam can be calculated directly from the degree of utilisation using either the relation 4.22 or the reduction factor for the steel strength in Table 2.4.1.

- On the basis of relation 4.22 of the fire part of Eurocode 3:

$$\theta_{cr} = 39,19 \ln \left[ \frac{1}{0,9674 \mu_0^{3,833}} - 1 \right] + 482 \approx 660 \text{ } ^\circ\text{C}$$

- On the basis of the reduction factor for the steel strength in Table 2.4.1:

From the interpolation between  $k_{y,\theta} = 0,47$  for  $600 \text{ } ^\circ\text{C}$  and  $k_{y,\theta} = 0,23$  for  $700 \text{ } ^\circ\text{C}$ , one can obtain  $\theta_{cr} \approx 667 \text{ } ^\circ\text{C}$ .

In fact, the first approach gives an approximate value of the critical temperature, though the second one provides its accurate value.

### 2.8.3.6 Step 6a: Calculation of the section factor of the unprotected steel beam

The section factor of four sides exposed and unprotected IPE360 is  $A_m/V=186 \text{ m}^{-1}$ . The box value of the section factor is  $(A_m/V)_b=146 \text{ m}^{-1}$ . The correction factor for the shadow effect may be determined according to the relation 4.26a as follows:

$$k_{sh} = 0,9 \left( \frac{A_m}{V} \right)_b \bigg/ \frac{A_m}{V} = 0,9 \cdot 146/186 = 0,706$$

### 2.8.3.7 Step 7a: Calculation of the heating of the unprotected steel beam

The heating of the beam can then be obtained from the relation 4.25 of the fire part of Eurocode 3 given below:

$$\Delta\theta_{a,t} = \frac{k_{sh}}{c_a \rho_a} \frac{A_m}{V} h_{net,d} \Delta t$$

If this relation is applied to the above beam with following assumption:

- Time interval: 3 seconds (0,05 minutes)
- Constant values for  $\rho_a$  and  $c_a$ :  $\rho_a=7850 \text{ kg/m}^3$  and  $c_a=600 \text{ J/kgK}$

it becomes:

$$\Delta\theta_{a,t} = \frac{k_{sh}}{c_a \rho_a} \frac{A_m}{V} h_{net,d} \Delta t = \frac{0,706}{600 \cdot 7850} \cdot 186 \cdot h_{net,d} \cdot 3 = 8,364 \cdot 10^{-5} h_{net,d}$$

However,  $h_{net,d}$  varies with time and is non-linear because:

$$h_{net,d} = h_{net,r} + h_{net,c}$$

with:

$$h_{net,r} = 5,67 \cdot 10^{-8} \Phi \epsilon_{res} \left( (\theta_g + 273)^4 - (\theta_a + 273)^4 \right) = 3,969 \cdot 10^{-8} \left( (\theta_g + 273)^4 - (\theta_a + 273)^4 \right)$$

$$h_{net,c} = \alpha_c (\theta_g - \theta_a) = 25 (\theta_g - \theta_a)$$

$$\theta_g = 20 + 345 \log(8t + 1) \quad (t \text{ in minutes})$$

The most relevant way to deal with  $h_{net,d}$  is to consider a mean value within the time interval  $\Delta t$  (3 seconds in this case) between instant  $t_i$  and  $t_{i+1}$ .

Hence, there is:

$$h_{net,r} = 3,969 \cdot 10^{-8} \left[ \frac{(\theta_{g,i} + 273)^4 + (\theta_{g,i+1} + 273)^4}{2} - (\theta_{a,i} + 273)^4 \right]$$

$$h_{net,c} = 25 \left( \frac{\theta_{g,i} + \theta_{g,i+1}}{2} - \theta_{a,i} \right)$$

The step by step incremental application of the above relations leads to a time duration of 16 minutes and 30 seconds to reach the critical temperature of 667 °C. The accurate calculation with  $c_a$  varying as a function of temperature gives a time duration of 17 minutes to reach the same critical temperature. In consequence, the fire resistance of this beam, if unprotected, is at least 16 minutes and 30 seconds.

#### 2.8.3.8 Step 4b: Degree of utilisation of the fire protected steel beam

Apparently, the fire resistance of the unprotected beam cannot meet the fire resistance requirement of the fire regulation which is 60 minutes. It simply means that the beam should be fire protected.

If the beam is fire protected, in general, the voids above the upper flange are filled. In this case, the beam can be considered as three sides exposed. Hence, there are  $k_1=0,85$  and  $k_2=1,0$  for simply supported beams.

In consequence:

- The modified degree of utilisation for the bending moment (on the basis of relation 4.10 of the fire part of Eurocode 3) is:

$$\mu_{0,M,\kappa} = \mu_{0,M} (\kappa_1 \kappa_2) = 0,308 \cdot (0,85 \cdot 1,0) = 0,262$$

- The modified degree of utilisation for the vertical shear is:

$$\mu_{0,V,\kappa} = \mu_{0,V} = 0,088$$

The final value for the degree of utilisation should be determined as follows:

$$\mu_0 = \max(\mu_{0,M,\kappa}; \mu_{0,V,\kappa}) = \max(0,262; 0,088) = 0,262$$

### 2.8.3.9 Step 5b: Calculation of the critical temperature of the fire protected beam

The critical temperature of the fire protected beam can be calculated directly from the degree of utilisation using either the relation 4.22 or the reduction factor for the steel strength in Table 2.4.1.

- On the basis of relation 4.22 of the fire part of Eurocode 3:

$$\theta_{cr} = 39,19 \ln \left[ \frac{1}{0,9674 \mu_0^{3,833}} - 1 \right] + 482 \approx 684 \text{ } ^\circ\text{C}$$

- On the basis of the reduction factor for the steel strength in Table 2.4.1:

From the interpolation between  $k_{y,\theta} = 0,47$  for  $600 \text{ } ^\circ\text{C}$  and  $k_{y,\theta} = 0,23$  for  $700 \text{ } ^\circ\text{C}$ , one can obtain  $\theta_{cr} \approx 687 \text{ } ^\circ\text{C}$ .

### 2.8.3.10 Step 6b: Calculation of the section factor of the fire protected steel beam

As the beam is three sides exposed, its section factor is simply  $A_p/V=163 \text{ m}^{-1}$  if the encasement type of fire protection is adopted.

### 2.8.3.11 Step 7b: Calculation of the heating of the steel beam protected with spray material

The heating of the beam can then be obtained from the rules given in §4.2.5.2 of the fire part of Eurocode 3.

In our case, the beam is considered to be protected with sprayed material and its thickness is 10 mm. The thermal properties of this material are:

- Density:  $\rho_p=350 \text{ kg/m}^3$
- Specific heat:  $c_p=1200 \text{ J/kg}^\circ\text{K}$
- Thermal conductivity:  $\lambda_p=0,12 \text{ W/m}^\circ\text{K}$

With the above data, the relation 4.25 of the fire part of Eurocode 3 can be applied. First of all, it is necessary to determine the coefficient  $\phi$ :

$$\phi = \frac{c_p \rho_p}{c_a \rho_a} d_p \frac{A_p}{V} = \frac{350 \cdot 1200}{600 \cdot 7850} \cdot 10 \cdot 10^{-3} \cdot 163 = 0,145$$

With a time interval taken equal to 3 seconds, the relation 4.25 can then be expressed as:

$$\Delta\theta_{a,t} = \frac{\lambda_p / d_p}{c_a \rho_a} \frac{A_p}{V} \left( \frac{1}{1 + \phi / 3} \right) (\theta_{g,t} - \theta_{a,t}) \Delta t - (e^{\phi/10} - 1) \Delta\theta_{g,t} = 1,188 \cdot 10^{-3} (\theta_{g,t} - \theta_{a,t}) - 1,464 \cdot 10^{-2} \Delta\theta_{g,t}$$

To apply the above relation with an Excel sheet, one can obtain very easily that the heating of the steel section IPE360 after a fire exposure of 60 minutes is about 643 °C.

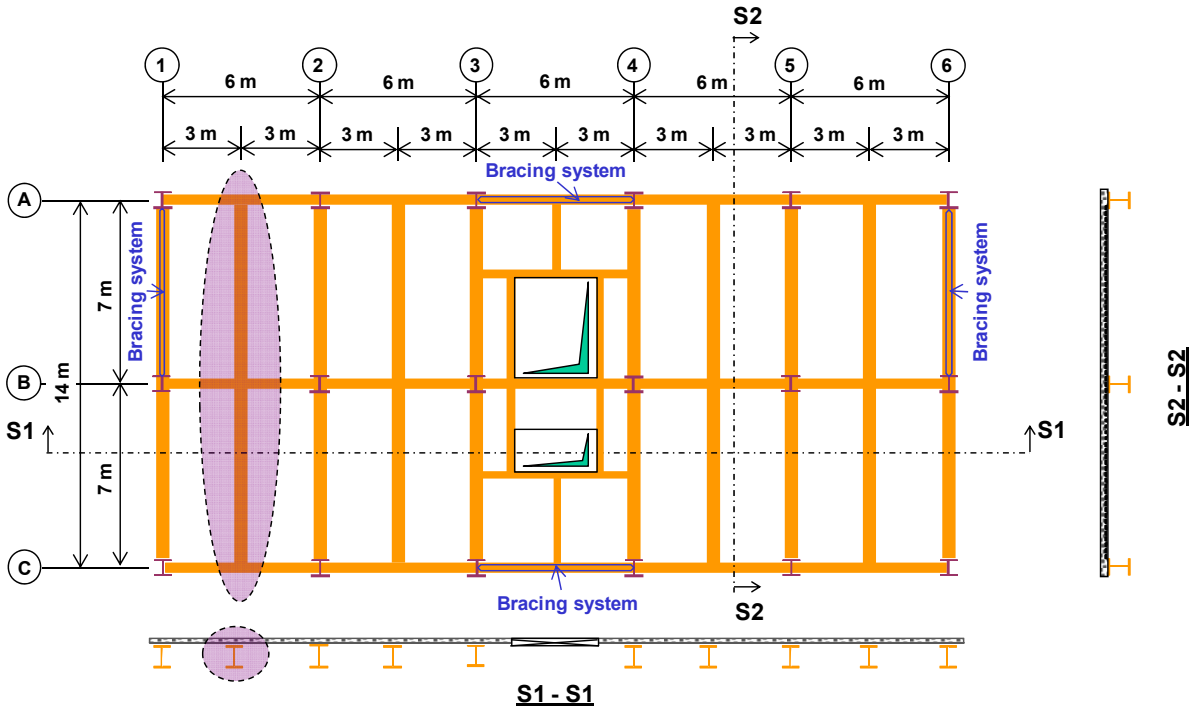
The above calculation can be made also with  $c_a$  varying as function of temperature leading to a heating of 631°C for the same beam.

Consequently, it can be found that the use of a constant value of  $c_a$  will lead to safe results for both unprotected and fire protected steel members.

In addition, one can check easily that the predicted fire protection is enough to ensure the fire resistance requirement of this beam.

### 2.8.4 Example 2: A Secondary beam under the central support of the continuous slab

The second worked example concerns the secondary beams under the central supports of the two-span continuous slabs (see Figure 2.8.8).



**Fig.2.8.8** Location of the selected steel beam for the second worked example

### 2.8.4.1 Step 1: Design loads in the fire situation

As in the first worked example, the loads applied to this beam come mainly from the slab over it. Considering that this beam is located under the central support of the slab, the load applied to the supporting beam should be  $1,25q_s l$  (see §2.9.1.1 for  $q_s$  and  $l$ ).

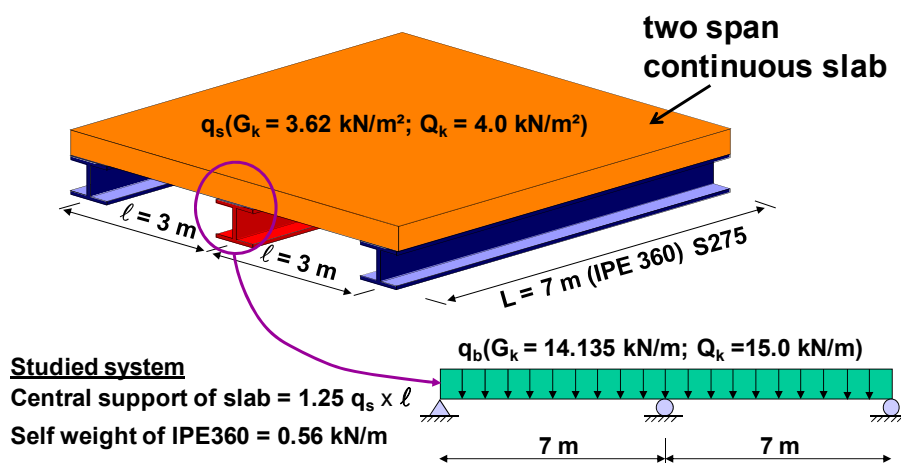
The applied loads over the slab in the fire situation are already determined in the first worked example (see §2.9.1.1). As a recall, the value of this load is given below:

$$q_{fi,d,t,s} = 6,02 \text{ kN/m}^2$$

In the fire situation, the design load of the beam IPE360, which self-weight is  $G_b=0,56 \text{ kN/m}$ , can be obtained as follows:

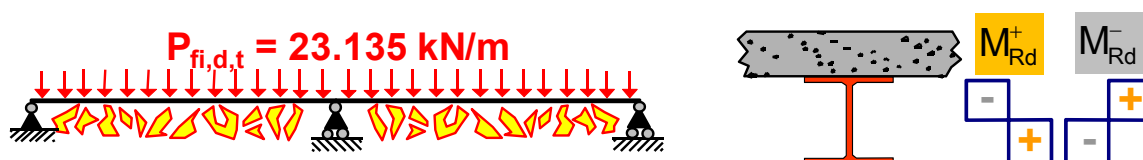
$$q_{fi,d,t} = G_b + 1,25 \left( \sum_{i \geq 1} G_{k,i} + 0,6 Q_{k,1} \right) l = G_b + 1,25 q_{fi,d,t,s} l = 23,135 \text{ kN/m}$$

This calculation is also clearly illustrated in Figure 2.8.9 given below.



**Fig.2.8.9** Loading condition of the selected steel beam in the fire situation

The loading condition of this beam is shown in Figure 2.8.10 given below.



**Fig.2.8.10** Applied load on the selected steel beam in the fire situation

### 2.8.4.2 Step 2: Classification of the steel beam

Since this beam is designed to have the same cross-section as the previous beam, it is then classified in the same way. In consequence, it can be very easily checked that this beam is in Class 1 and its fire resistance can be determined using plastic analysis.

### 2.8.4.3 Step 3: Determination of the design resistance of the steel beam at room temperature

As it concerns a continuous beam, its fire resistance design has to be dealt with on the basis of the global load-bearing capacity to be derived from the internal forces such as the bending moment and the vertical shear.

First of all, it is necessary to determine the ultimate moment and vertical shear resistances of this beam on the basis of §6.2.5 and §6.2.6 of Eurocode 3 part 1-1 (EN 1993-1-1).

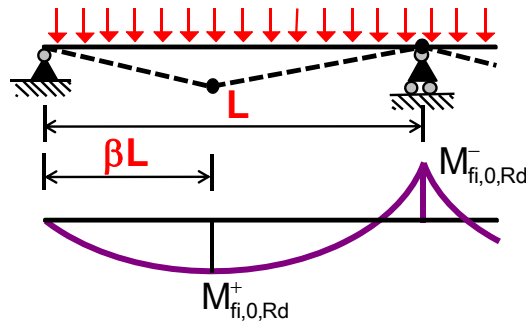
- From relation 6.13 of Eurocode 3 part 1-1:

$$M_{Rd} = M_{pl,Rd} = \frac{W_{pl,y} f_y}{\gamma_{M0}} = \frac{1019 \cdot 10^3 \cdot 275}{1,0} = 280,3 \text{ kNm}$$

- From relation 6.18 of Eurocode 3 part 1-1:

$$V_{Rd} = V_{pl,Rd} = \frac{A_v (f_y / \sqrt{3})}{\gamma_{M0}} = \frac{3514 \cdot (275 / \sqrt{3})}{1,0} = 557,9 \text{ kN}$$

The load-bearing capacity of the beam can be then determined from the plastic hinge theory (see Figure 2.8.11).



**Fig.2.8.11** Plastic mechanism of a two-span continuous beam

From the plastic mechanism analysis, it can be easily shown that three plastic hinges are necessary to reach the plastic mechanism of this beam. One of these plastic hinges is inevitably located at the central support and the other two are situated inside the two different spans. In case of two equal spans, there are:

- parameter  $\beta$  for the position of the plastic hinge inside the span

$$\beta = \sqrt{1+n} - 1/n$$

with  $n = |M_{Rd}^- / M_{Rd}^+|$ .

Hence, the load-bearing capacity of the beam is:

$$q_{fi,0,Rd} = 2 M_{fi,0,Rd}^+ / (\beta L)^2$$



However, another criterion shall be met in order to reach the above load-bearing capacity which is relative to the vertical shear. The check of this criterion consists of comparing the vertical shear resistance with the applied vertical shear derived from the ultimate load-bearing capacity obtained on the basis of the bending moment resistance as follows:

$$V_{Rd} \geq V_{fi,0,Rd}^{(n)}$$

with  $V_{fi,0,Rd}^{(n)} = q_{fi,0,Rd} L/2 + M_{fi,0,Rd}^+ / L$  .

As already explained in the first worked example, the load-bearing capacity of the beam shall take account of the influence of the adaptation factors for bending moment resistance. Therefore, according to relation 4.10 of the fire part of Eurocode 3:

- in case of an unprotected beam (four sides exposed steel section)
  - the sagging moment resistance is:

$$\left. \begin{array}{l} k_1 = 1,0 \\ k_2^+ = 1,0 \end{array} \right\} \Rightarrow M_{fi,0,Rd}^+ = \frac{M_{Rd}}{k_1 k_2^+} \frac{\gamma_{M0}}{\gamma_{M,fi}} = 280,3 \text{ kNm}$$

- the hogging moment resistance is:

$$\left. \begin{array}{l} k_1 = 1,0 \\ k_2^- = 0,85 \end{array} \right\} \Rightarrow M_{fi,0,Rd}^- = \frac{M_{Rd}}{k_1 k_2^-} \frac{\gamma_{M0}}{\gamma_{M,fi}} = 329,7 \text{ kNm}$$

From the plastic analysis, one can have:

$$n = |M_{Rd}^- / M_{Rd}^+| = \kappa_2^+ / \kappa_2^- = 1,176$$

$$\beta = \sqrt{1+n} - 1/n = 0,404$$

$$q_{fi,0,Rd} = 2 M_{Rd}^+ / (\beta L)^2 = 70,1 \text{ kN/m}$$

The applied vertical shear with the above load-bearing capacity is:

$$V_{fi,0,Rd}^{(n)} = q_{fi,0,Rd} L/2 + M_{fi,0,Rd}^+ / L = 292,4 \text{ kN}$$

This vertical shear is largely smaller than the vertical shear resistance calculated previously which is 557,9 kN. Hence, no specific attention is needed to the calculation of the degree of utilisation for this beam with respect to vertical shear.

- In case of a fire protected beam (three sides exposed steel section):
  - The sagging moment resistance at room temperature is:

$$\left. \begin{array}{l} k_1 = 0,85 \\ k_2^+ = 1,0 \end{array} \right\} \Rightarrow M_{fi,0,Rd}^+ = \frac{M_{Rd}}{k_1 k_2^+} \frac{\gamma_{M0}}{\gamma_{M,fi}} = 329,7 \text{ kNm}$$

- The hogging moment resistance at room temperature is:

$$\left. \begin{array}{l} k_1 = 0,85 \\ k_2^- = 0,85 \end{array} \right\} \Rightarrow M_{fi,0,Rd}^- = \frac{M_{Rd}}{k_1^- k_2^-} \frac{\gamma_{M0}}{\gamma_{M,fi}} = 387,9 \text{ kNm}$$

From the plastic analysis, one can have:

$$n = |M_{Rd}^- / M_{Rd}^+| = \kappa_2^+ / \kappa_2^- = 1,176$$

$$\beta = \sqrt{1+n} - 1/n = 0,404$$

$$q_{fi,0,Rd} = 2 M_{Rd}^+ / (\beta L)^2 = 82,5 \text{ kN/m}$$

The applied vertical shear with the above load-bearing capacity is:

$$V_{fi,0,Rd}^{(n)} = q_{fi,0,Rd} L/2 + M_{fi,0,Rd}^+ / L = 344,0 \text{ kN}$$

Once again, this vertical shear is largely smaller than the vertical shear resistance calculated previously which is 557,9 kN. Hence, no specific attention is needed to the calculation of the degree of utilisation for this beam.

#### 2.8.4.4 Step 4a: Degree of utilisation of the unprotected steel beam

After having determined the load-bearing capacity of the beam, the degree of utilisation of the beam can be directly derived as follows:

$$\mu_0 = q_{fi,d,t} / q_{fi,0,Rd} = 23,135/70,1 \approx 0,330$$

#### 2.8.4.5 Step 5a: Calculation of the critical temperature of the unprotected beam

The critical temperature of the beam can be calculated easily from the degree of utilisation using either the relation 4.22 or the reduction factor for the steel strength in Table 2.4.1.

- On the basis of relation 4.22 of the fire part of Eurocode 3:

$$\theta_{cr} = 39,19 \ln \left[ \frac{1}{0,9674 \mu_0^{3,833}} - 1 \right] + 482 \approx 649^\circ \text{C}$$

- On the basis of the reduction factor for the steel strength in Table 2.4.1:

From the interpolation between  $k_{y,\theta} = 0,47$  for  $600^\circ \text{C}$  and  $k_{y,\theta} = 0,23$  for  $700^\circ \text{C}$ , one can obtain  $\theta_{cr} \approx 667^\circ \text{C}$ .

#### 2.8.4.6 Step 6a: Calculation of the section factor of the unprotected steel beam

The section factor of four sides exposed and unprotected IPE360 is  $A_m/V=186 \text{ m}^{-1}$ . The box value of the section factor is  $A_m/V=146 \text{ m}^{-1}$ . The correction factor for the shadow effect may be determined according to relation 4.26a as follows:

$$k_{sh} = 0,9 \left( \frac{A_m}{V} \right)_b / \frac{A_m}{V} = 0,9 \cdot 146/186 = 0,706$$

#### 2.8.4.7 Step 7a: Calculation of the heating of the unprotected steel beam

The heating of the beam can then be obtained from the relation 4.25 of the fire part of Eurocode 3 given below:

$$\Delta\theta_{a,t} = \frac{k_{sh}}{c_a \rho_a} \frac{A_m}{V} h_{net,d} \Delta t$$

If this relation is applied to the above beam with following assumption:

- Time interval: 3 seconds (0,05 minutes)
- Constant values for  $\rho_a$  and  $c_a$ :  $\rho_a = 7850 \text{ kg/m}^3$  and  $c_a = 600 \text{ J/kgK}$ .

it becomes:

$$\Delta\theta_{a,t} = \frac{k_{sh}}{c_a \rho_a} \frac{A_m}{V} h_{net,d} \Delta t = \frac{0,706}{600 \cdot 7850} \cdot 186 h_{net,d} \cdot 3 = 8,364 \cdot 10^{-5} h_{net,d}$$

However,  $h_{net,d}$  varies with time and is non-linear because:

$$h_{net,d} = h_{net,r} + h_{net,c}$$

with:

$$h_{net,r} = 5,67 \cdot 10^{-8} \Phi \varepsilon_{res} \left( (\theta_g + 273)^4 - (\theta_a + 273)^4 \right) = 3,969 \cdot 10^{-8} \left( (\theta_g + 273)^4 - (\theta_a + 273)^4 \right)$$

$$h_{net,c} = \alpha_c (\theta_g - \theta_a) = 25 (\theta_g - \theta_a)$$

$$\theta_g = 20 + 345 \log(8t + 1) \quad (t \text{ in minutes}).$$

The most relevant way to deal with  $h_{net,d}$  is to consider a mean value within the time interval  $\Delta t$  (3 seconds in this case) between instant  $t_i$  and  $t_{i+1}$ .

Hence, there is:

$$h_{net,r} = 3,969 \cdot 10^{-8} \left[ \frac{(\theta_{g,i} + 273)^4 + (\theta_{g,i+1} + 273)^4}{2} - (\theta_{a,i} + 273)^4 \right]$$

$$h_{net,c} = 25 \left( \frac{\theta_{g,i} + \theta_{g,i+1}}{2} - \theta_{a,i} \right)$$

The step by step incremental application of the above relations leads to a time duration of 15 minutes and 54 seconds to reach the critical temperature of 658 °C. The accurate calculation with  $c_a$  varying with the temperature gives a time duration of 16 minutes and 30 seconds to reach the critical

temperature. In consequence, the fire resistance of this beam, if unprotected, is at least 15 minutes and 54 seconds.

#### 2.8.4.8 Step 4b: Degree of utilisation of the fire protected steel beam

From the obtained load-bearing capacity of the fire protected beam, its degree of utilisation can be directly derived as follows:

$$\mu_0 = q_{f,d,t} / q_{f,0,Rd} = 23,135 / 82,5 \approx 0,281$$

#### 2.8.4.9 Step 5b: Calculation of the critical temperature of the fire protected beam

The critical temperature of this fire protected beam can be calculated directly from the degree of utilisation using either the relation 4.22 or the reduction factor for steel strength in Table 2.4.1.

- On the basis of relation 4.22 of the fire part of Eurocode 3:

$$\theta_{cr} = 39,19 \ln \left[ \frac{1}{0,9674 \mu_0^{3,833}} - 1 \right] + 482 \approx 674 \text{ } ^\circ\text{C}$$

- On the basis of the reduction factor for steel strength in Table 2.4.1:

From the interpolation between  $k_{y,\theta} = 0,47$  for  $600 \text{ } ^\circ\text{C}$  and  $k_{y,\theta} = 0,23$  for  $700 \text{ } ^\circ\text{C}$ , one can obtain  $\theta_{cr} \approx 679 \text{ } ^\circ\text{C}$ .

#### 2.8.4.10 Step 6b: Calculation of the section factor of the fire protected steel beam

As the beam is three sides exposed, its section factor is simply  $A_m/V=163 \text{ m}^{-1}$  if the encasement type of fire protection is adopted.

#### 2.8.4.11 Step 7b: Calculation of the heating of the steel beam protected with spray material

The heating of the beam can then be obtained from the rules given in §4.2.5.2 of the fire part of Eurocode 3.

In our case, the beam is considered to be protected with sprayed material and its thickness is 10 mm. The thermal properties of this material are:

- Density:  $\rho_p=350 \text{ kg/m}^3$
- Specific heat:  $c_p=1200 \text{ J/kg}^\circ\text{K}$
- Thermal conductivity:  $\lambda_p=0,12 \text{ W/m}^\circ\text{K}$

With the above data, the relation 4.25 of the fire part of Eurocode 3 can be applied. First of all, it is necessary to determine the coefficient  $\phi$ :

$$\phi = \frac{c_p \rho_p}{c_a \rho_a} d_p \frac{A_p}{V} = \frac{350 \cdot 1200}{600 \cdot 7850} \cdot 10 \cdot 10^{-3} \cdot 163 = 0,145$$

With a time interval taken equal as 3 seconds, the relation 4.25 can then be expressed as:

$$\Delta\theta_{a,t} = \frac{\lambda_p / d_p}{c_a \rho_a} \frac{A_p}{V} \left( \frac{1}{1 + \phi/3} \right) (\theta_{g,t} - \theta_{a,t}) \Delta t - (e^{\phi/10} - 1) \Delta\theta_{g,t} = 1,188 \cdot 10^{-3} (\theta_{g,t} - \theta_{a,t}) - 1,464 \cdot 10^{-2} \Delta\theta_{g,t}$$

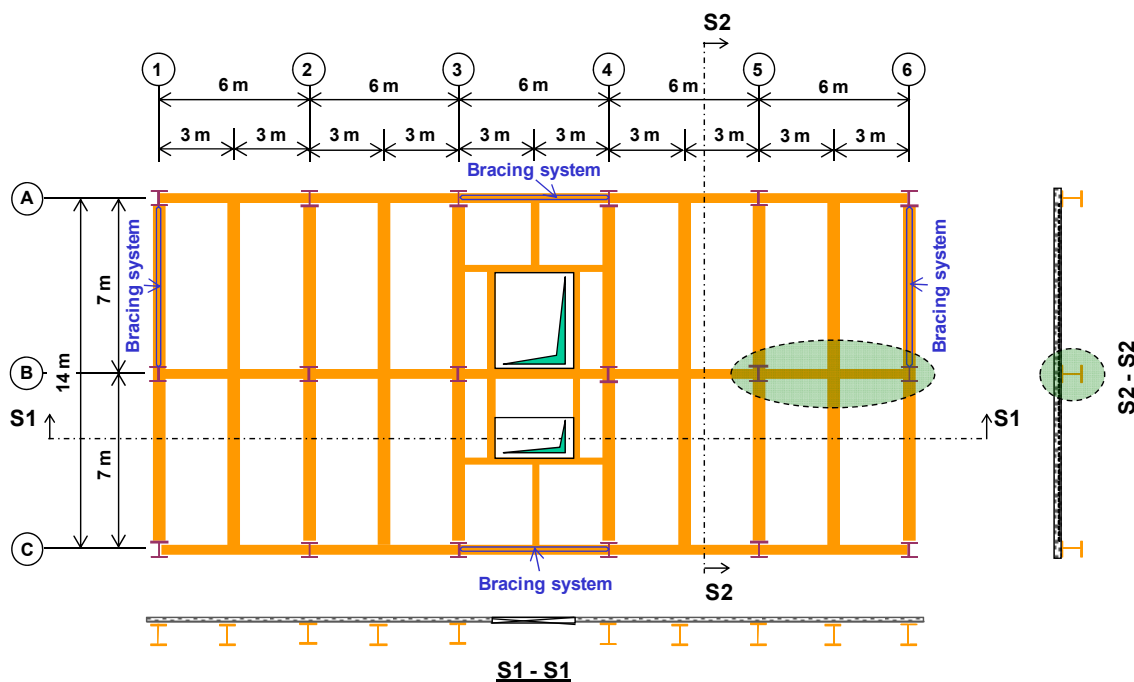
To apply the above relation with an Excel sheet, one can obtain very easily that the heating of the steel section IPE360 after a fire exposure of 60 minutes is about 643 °C.

The above calculation can also be made with  $c_a$  varying as function of temperature leading to a heating of 631 °C for the same beam.

One can check very easily that the predicted fire protection is enough to ensure the fire resistance requirement of this beam.

### 2.8.5 Example 3: Simply supported central main beam

The third worked example concerns the central main beams (see Figure 2.8.12) designed as simply supported beams with single spans.



**Fig.2.8.12** Location of the selected steel beam for the third worked example

#### 2.8.5.1 Step 1: Design loads in the fire situation

This beam receives a concentrated load at its mid-span coming from the two-span continuous secondary beam. In the second example, it was shown that in the fire situation the loads applied to the secondary beam are uniformly distributed with a value of 23,135kN/m. Therefore, the concentrated load applied to the concerned main beam is the central support reaction of the secondary beam which should be  $1,25qL$  (see Figure 2.8.12 for  $q$  and  $L$ ).

In the fire situation, the design load of this main beam HEA360, which self-weight is  $G_b=1,12$  kN/m, can be obtained as follows:

- Concentrated load at mid-span:

$$P_{fi,d,t} = 1,25 \left( \sum_{i \geq 1} G_{k,j} + 0,6Q_{k,1} \right) L = 1,25qL = 1,25 \cdot 23,135 \cdot 7 = 202,4 \text{ kN}$$

- Uniformly distributed load (self-weight of the beam):

$$q_{fi,d,t} = G_{k,1} + \psi_{2,1}Q_{k,1} = 1,12 \text{ kN/m}$$

This calculation is also clearly illustrated in Figure 2.8.13 given below.

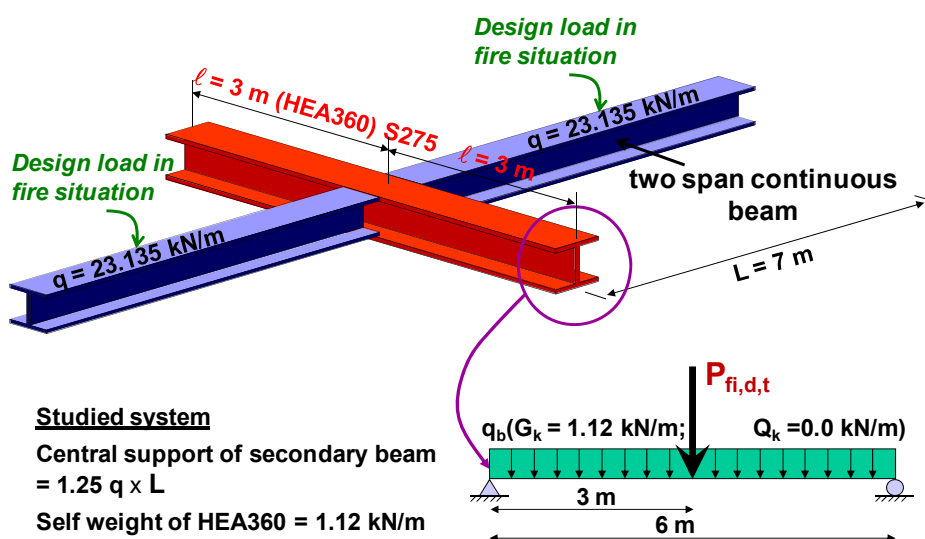


Fig.2.8.13 Loading condition of the selected steel beam in the fire situation

The accurate loading condition of this beam in the fire situation is shown in Figure 2.8.14 given below.



Fig.2.8.14 Applied load on the selected steel beam in the fire situation

For this beam, the above applied load in the fire situation leads to the following maximum internal forces:

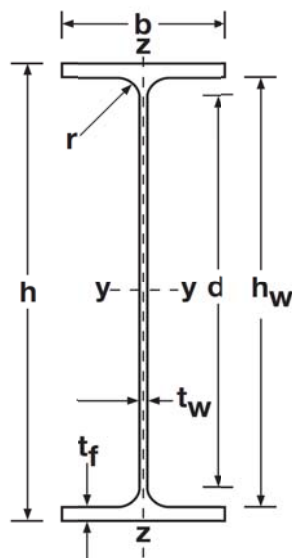
- bending moment:
 
$$M_{fi,d,t} = \frac{q_{fi,d,t}l^2}{2} + \frac{P_{fi,d,t}l}{2} = 308,6 \text{ kNm}$$
- vertical shear:
 
$$V_{fi,d,t} = q_{fi,d,t}l + \frac{P_{fi,d,t}}{2} = 104,5 \text{ kN}$$

### 2.8.5.2 Step 2: Classification of the steel beam

The classification of this beam can be made by combining the Table 5.2 of Eurocode 3, part 1-1 (EN 1993-1-1) and the relation 4.2 of the fire part of Eurocode 3 (EN 1993-1-2). The two wall elements of the cross-section, that are the flange and the web, have to be checked.

The dimensions of the HEA360 cross-section of this beam are summarized below (see Figure 2.8.15):

$$H = 350 \text{ mm} \quad B = 300 \text{ mm} \quad t_w = 10,0 \text{ mm} \quad t_f = 17,5 \text{ mm} \quad r = 27 \text{ mm} \quad h_w = 315 \text{ mm} \quad d = 261 \text{ mm}$$



**Fig.2.8.15** Dimension notation of I or H shape steel profile

According to relation 4.2 of the fire part of Eurocode 3 (EN 1993-1-2):

$$\varepsilon = 0,85\sqrt{235/f_y} = 0,786 \quad \text{with steel grade S275}$$

On the other hand, according to Table 5.2 of Eurocode 3, part 1-1, the criteria of Class 1 for flange and web are:

- web:  $c/t_w \leq 72\varepsilon \Rightarrow c/t_w \leq 72\varepsilon \Rightarrow d/t_w \leq 72\varepsilon = 56,6$
- flange:  $c/t_f \leq 9\varepsilon \Rightarrow (B/2 - t_w/2 - r)/t_f \leq 9\varepsilon = 7,07$

With the dimensions given above, there are:

- web:  $d/t_w = 261,0/10,0 = 26,1 < 56,6$
- flange:  $(B/2 - t_w/2 - r)/t_f = (350/2 - 10,0/2 - 27)/17,5 = 6,74 < 7,07$

The beam is then classified as Class 1 and can develop full plastic moment resistance.

### 2.8.5.3 Step 3: Determination of the design resistance of the steel beam at room temperature

The ultimate moment and vertical shear resistances of this beam may be obtained on the basis of §6.2.5 and §6.2.6 of Eurocode 3 part 1-1 (EN 1993-1-1).

- From relation 6.13 of Eurocode 3 part 1-1:

$$M_{Rd} = M_{pl,Rd} = \frac{W_{pl,y} \cdot f_y}{\gamma_{M0}} = \frac{2088,47 \cdot 10^3 \cdot 275}{1,0} = 574,3 \text{ kNm}$$

- From relation 6.18 of Eurocode 3 part 1-1:

$$V_{Rd} = V_{pl,Rd} = \frac{A_v \cdot (f_y / \sqrt{3})}{\gamma_{M0}} = \frac{4896 \cdot (275 / \sqrt{3})}{1,0} = 777,3 \text{ kN}$$

### 2.8.5.4 Step 4a: Degree of utilisation of the unprotected steel beam

Two resistance factors can determine the load-bearing capacity of the beam - the bending moment and the vertical shear. From the relation 4.24 of the fire part of Eurocode 3:

- with respect to the bending moment:

$$\mu_{0,M} = \eta_{fi,M} \frac{\gamma_{M0}}{\gamma_{M,fi}} = \frac{M_{fi,d,t}}{M_{Rd}} \frac{\gamma_{M0}}{\gamma_{M,fi}} = \frac{308,6}{574,3} \cdot \frac{1,0}{1,0} = 0,537$$

- with respect to the vertical shear:

$$\mu_{0,V} = \eta_{fi,V} \frac{\gamma_{M0}}{\gamma_{M,fi}} = \frac{V_{fi,d,t}}{V_{Rd}} \frac{\gamma_{M0}}{\gamma_{M,fi}} = \frac{104,5}{777,3} \cdot \frac{1,0}{1,0} = 0,134$$

As the beam is covered above with a floor slab, the impact of the kappa factors relative to the temperature gradient over its depth should be taken into account. However, they have an impact only on the bending moment because no rule is provided to the vertical shear. In addition, as the kappa factors are different for unprotected and fire protected beams, two degrees of utilisation may be obtained. Both unprotected and protected beams are considered as three sides exposed due to the fact that the steel deck of the composite slab is parallel to the steel beam and covers fully the upper face of the upper flange of the beam. Hence, there are  $\kappa_1=0,7$  and  $\kappa_2=1,0$  (for simply supported beams).

In consequence:

- The modified degree of utilisation for the bending moment (on the basis of relation 4.10 of the fire part of Eurocode 3) is:

$$\mu_{0,M,\kappa} = \mu_{0,M} (\kappa_1 \kappa_2) = 0,537 \cdot (0,7 \cdot 1,0) = 0,376$$

- The modified degree of utilisation for the vertical shear is:

$$\mu_{0,V,\kappa} = \mu_{0,V} = 0,134$$

The final value for the degree of utilisation should be determined as follows:



$$\mu_0 = \max(\mu_{0,M,\kappa}; \mu_{0,V,\kappa}) = \max(0,376; 0,134) = 0,376$$

### 2.8.5.5 Step 5a: Calculation of the critical temperature of the unprotected beam

The critical temperature of the beam can be calculated directly from the degree of utilisation using either the relation 4.22 or the reduction factor for the steel strength in Table 2.4.1.

- On the basis of relation 4.22 of the fire part of Eurocode 3:

$$\theta_{cr} = 39,19 \ln \left[ \frac{1}{0,9674 \mu_0^{3,833}} - 1 \right] + 482 \approx 629 \text{ } ^\circ\text{C}$$

- On the basis of the reduction factor for the steel strength in Table 2.4.1:

From the interpolation between  $k_{y,\theta}=0,47$  for  $600 \text{ } ^\circ\text{C}$  and  $k_{y,\theta}=0,23$  for  $700 \text{ } ^\circ\text{C}$ , one can obtain  $\theta_{cr} \approx 639 \text{ } ^\circ\text{C}$ .

### 2.8.5.6 Step 6a: Calculation of the section factor of the unprotected steel beam

The section factor of three sides exposed and unprotected HEA360 is  $A_m/V=107 \text{ m}^{-1}$ . The box value of the section factor is  $(A_m/V)_b=70 \text{ m}^{-1}$ . The correction factor for the shadow effect may be determined according to relation 4.26a as follows:

$$k_{sh} = 0,9 \left( \frac{A_m}{V} \right)_b \bigg/ \frac{A_m}{V} = 0,9 \cdot 70/107 \approx 0,589$$

### 2.8.5.7 Step 7a: Calculation of the heating of the unprotected steel beam

The heating of the beam can then be obtained from relation 4.25 of the fire part of Eurocode 3 given below:

$$\Delta\theta_{a,t} = \frac{k_{sh}}{c_a \rho_a} \frac{A_m}{V} h_{net,d} \Delta t$$

If this relation is applied to the above beam with following assumption:

- Time interval: 3 seconds (0,05 minutes)
- Constant values for  $\rho_a$  and  $c_a$ :  $\rho_a=7850 \text{ kg/m}^3$  and  $c_a=600 \text{ J/kgK}$

It becomes:

$$\Delta\theta_{a,t} = \frac{k_{sh}}{c_a \rho_a} \frac{A_m}{V} h_{net,d} \Delta t = \frac{0,589}{600 \cdot 7850} \cdot 107 h_{net,d} \cdot 3 = 4,014 \cdot 10^{-5} h_{net,d}$$

However,  $h_{net,d}$  varies with time and is non-linear because:

$$h_{net,d} = h_{net,r} + h_{net,c}$$

with:

$$h_{net,r} = 5,67 \cdot 10^{-8} \Phi \varepsilon_{res} \left( (\theta_g + 273)^4 - (\theta_a + 273)^4 \right) = 3,969 \cdot 10^{-8} \left( (\theta_g + 273)^4 - (\theta_a + 273)^4 \right)$$

$$h_{net,c} = \alpha_c (\theta_g - \theta_a) = 25 (\theta_g - \theta_a)$$

$$\theta_g = 20 + 345 \log(8t + 1) \quad (t \text{ in minutes})$$

The most relevant way to deal with  $h_{net,d}$  is to consider a mean value within the time interval  $\Delta t$  (3 seconds in this case) between instant  $t_i$  and  $t_{i+1}$ .

Hence, there is:

$$h_{net,r} = 3,969 \cdot 10^{-8} \left[ \frac{(\theta_{g,i} + 273)^4 + (\theta_{g,i+1} + 273)^4}{2} - (\theta_{a,i} + 273)^4 \right]$$

$$h_{net,c} = 25 \left( \frac{\theta_{g,i} + \theta_{g,i+1}}{2} - \theta_{a,i} \right)$$

The step by step incremental application of the above relations leads to a time duration of 22 minutes and 45 seconds to reach the critical temperature of 639 °C. The accurate calculation with  $c_a$  varying as a function of temperature gives a time duration of 23 minutes and 10 seconds to reach the same critical temperature. In consequence, the fire resistance of this beam, if unprotected, is at least 22 minutes and 45 seconds.

#### 2.8.5.8 Step 4b: Degree of utilisation of the fire protected steel beam

Apparently, the fire resistance of the unprotected beam cannot meet the requirement of the fire regulation which is 60 minutes. It simply means that the beam needs to be fire protected.

If the beam is fire protected, the voids above the upper flange are quite commonly filled. In this case, the beam can be considered as three sides exposed. Hence, there are  $k_1=0,85$  and  $k_2=1,0$  (for simply supported beams).

In consequence:

- The modified degree of utilisation for the bending moment (on the basis of relation 4.10 of the fire part of Eurocode 3 is:

$$\mu_{0,M,\kappa} = \mu_{0,M} (\kappa_1 \kappa_2) = 0,537 \cdot (0,85 \cdot 1,0) = 0,457$$

- The modified degree of utilisation for the vertical shear is:

$$\mu_{0,V,\kappa} = \mu_{0,V} = 0,134$$

The final value for the degree of utilisation should be determined as follows:

$$\mu_0 = \max(\mu_{0,M,\kappa}; \mu_{0,V,\kappa}) = \max(0,457; 0,134) = 0,457$$

### 2.8.5.9 Step 5b: Calculation of the critical temperature of the fire protected beam

The critical temperature of the fire protected beam can be calculated directly from the degree of utilisation using either the relation 4.22 or the reduction factor for the steel strength in Table 2.4.1.

- On the basis of relation 4.22 of the fire part of Eurocode 3:

$$\theta_{cr} = 39,19 \ln \left[ \frac{1}{0,9674 \mu_0^{3,833}} - 1 \right] + 482 \approx 599 \text{ } ^\circ\text{C}$$

- On the basis of the reduction factor for the steel strength in Table 2.4.1:

From the interpolation between  $k_{y,\theta}=0,47$  for  $600 \text{ } ^\circ\text{C}$  and  $k_{y,\theta}=0,23$  for  $700 \text{ } ^\circ\text{C}$ , one can obtain  $\theta_{cr} \approx 606 \text{ } ^\circ\text{C}$ .

### 2.8.5.10 Step 6b: Calculation of the section factor of the fire protected steel beam

As the beam is three sides exposed, its section factor is simply  $A_m/V=107 \text{ m}^{-1}$  because the encasement type of fire protection is adopted for this beam.

### 2.8.5.11 Step 7b: Calculation of the heating of the steel beam protected with spray material

The heating of the beam can then be obtained from the rules given in §4.2.5.2 of the fire part of Eurocode 3.

In our case, the beam is considered to be protected with sprayed material and its thickness is 10 mm. The thermal properties of this material are:

- Density:  $\rho_p=350 \text{ kg/m}^3$
- Specific heat:  $c_p=1200 \text{ J/kg}^\circ\text{K}$
- Thermal conductivity:  $\lambda_p=0,12 \text{ W/m}^\circ\text{K}$

With above data, the relation 4.25 of the fire part of Eurocode 3 can be applied. First of all, it is necessary to determine the coefficient  $\phi$ :

$$\phi = \frac{c_p \rho_p}{c_a \rho_a} d_p \frac{A_p}{V} = \frac{350 \cdot 1200}{600 \cdot 7850} \cdot 10 \cdot 10^{-3} \cdot 107 = 0,0954$$

With a time interval equal to 3 seconds, the relation 4.25 can then be expressed as:

$$\Delta\theta_{a,t} = \frac{\lambda_p / d_p}{c_a \rho_a} \frac{A_p}{V} \left( \frac{1}{1 + \phi / 3} \right) (\theta_{g,t} - \theta_{a,t}) \Delta t - (e^{\phi/10} - 1) \Delta\theta_{g,t} = 7,926 \cdot 10^{-4} (\theta_{g,t} - \theta_{a,t}) - 9,587 \cdot 10^{-3} \Delta\theta_{g,t}$$

To apply the above relation with an Excel sheet, one can obtain very easily that the heating of the steel section HEA360 after a fire exposure of 60 minutes is about  $514 \text{ } ^\circ\text{C}$ .

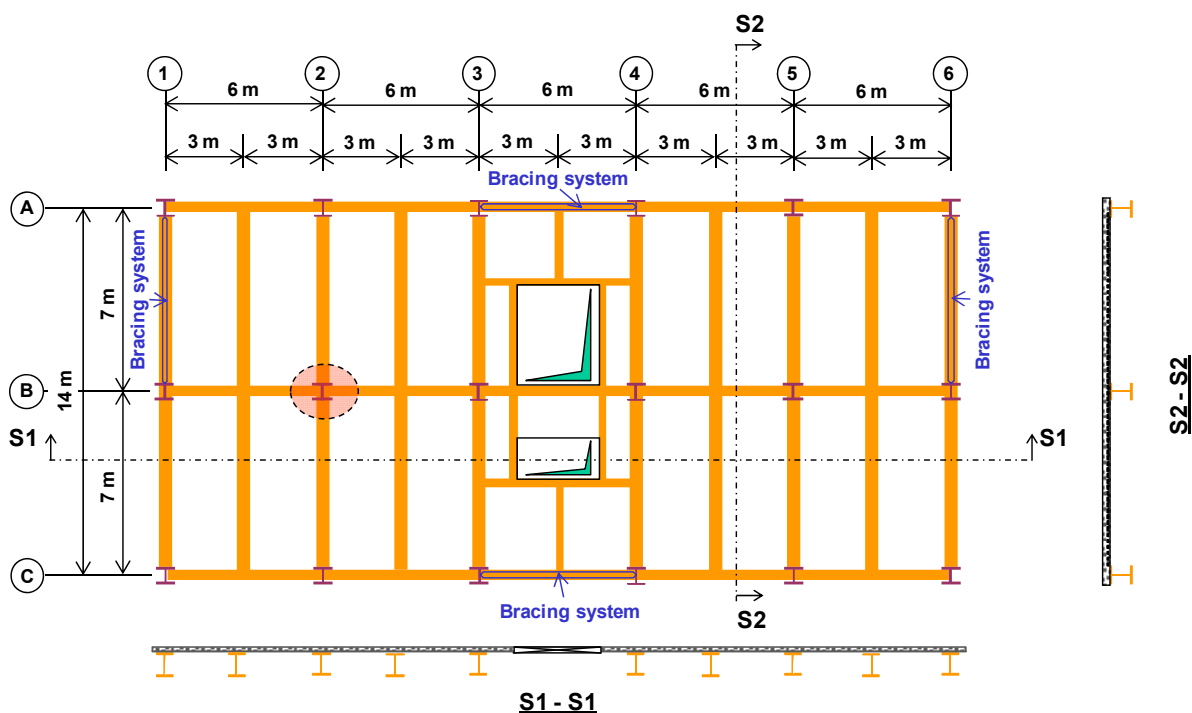
The above calculation can also be made with  $c_a$  varying as function of temperature leading to a heating of  $527 \text{ } ^\circ\text{C}$  for the same beam.

In fact, one can find that the use of a constant value for  $c_a$  will lead to safe results for both unprotected and fire protected steel members.

Also, one can check very easily that the predicted fire protection is enough to ensure the fire resistance requirement of this beam.

### 2.8.6 Example 4: Central column at the ground floor

The fourth worked example concerns the central columns at the ground floor (see Figure 2.8.16). These columns support the six floor levels.



**Fig.2.8.16** Location of the selected column for the fourth worked example

#### 2.8.6.1 Step 1: Design load in the fire situation

At each floor level, this column receives concentrated loads from the two simply supported secondary beams and the two simply supported central main beams. In the first example, it was shown that in the fire situation the applied loads to the simply supported secondary beam are uniformly distributed with a value of 14,105 kN/m. In the third example, it was shown that in the fire situation the applied loads to the simply supported central main beams are: concentrated load at the mid-span with a value of 202,4 kN and uniformly distributed load with a value of 1,12kN/m. Therefore, the concentrated load applied to this column includes the support reactions of both the secondary beam above and the main beam. In addition to the above mentioned load, the self-weight of the column, which is 1,15kN/m, should be taken into account. Therefore, the applied load to this column can be calculated as follows:

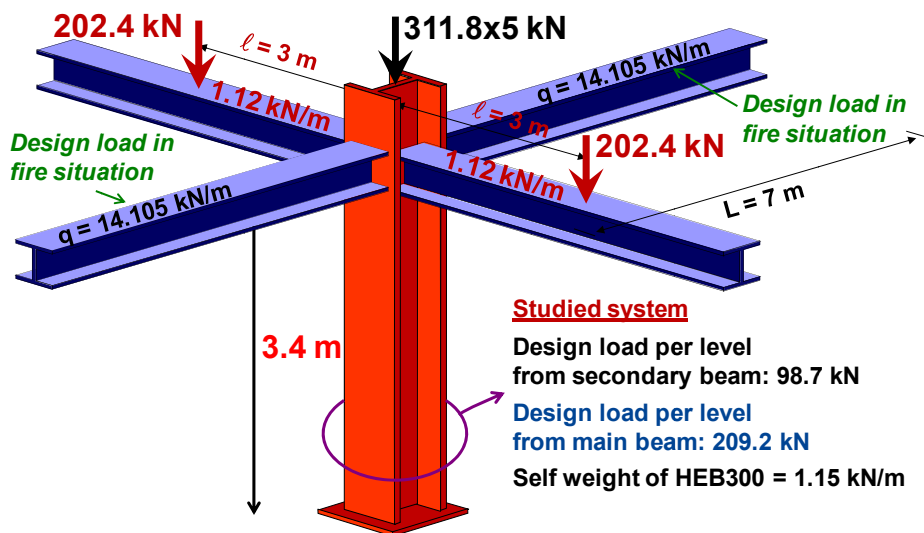
- At each level, the concentrated load from the beams is:

$$P_{fi,d,t} = \sum (G_{k,1} + \psi_{2,1} Q_{k,1}) = \underbrace{14,105 \cdot 7}_{\text{secondary beam}} + \underbrace{202,4 + 1,12 \cdot 6}_{\text{main beam}} \approx 307,9 \text{ kN}$$

- The self-weight of the column per level (conservatively with the same cross-section over the whole height of the building) is:

$$q_{fi,d,t} = 1,148 \cdot 3,4 \approx 3,9 \text{ kN/m}$$

This calculation is also clearly illustrated in Figure 2.8.17 given below.

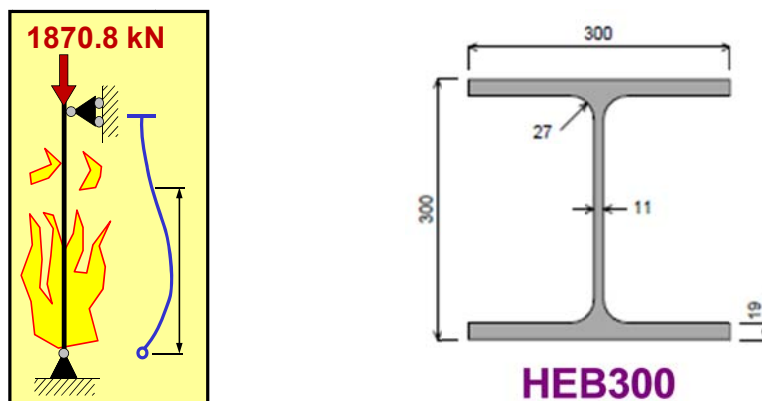


**Fig.2.8.17** Loading condition of the central column at the ground floor in the fire situation

Then, the total applied axial load to this column is:

$$N_{fi,d,t} = (307,9 + 3,9) \cdot 6 = 1870,8 \text{ kN}$$

The accurate loading condition of this column in the fire situation is shown in Figure 2.8.18 given below.



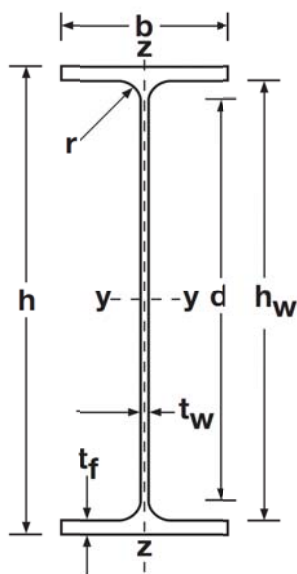
**Fig.2.8.18** Applied load on the selected steel column in the fire situation

### 2.8.6.2 Step 2: Classification of the steel column

The classification of this column can be made by combining Table 5.2 of Eurocode 3, part 1-1 (EN 1993-1-1) and relation 4.2 of the fire part of Eurocode 3 (EN 1993-1-2) with a cross-section fully in compression. The two wall elements of the cross-section, that are the flange and the web, have to be checked.

The dimensions of the HEB300 cross-section of this column are summarized below (see Figures 2.8.18 and 2.8.19):

$$H = 300 \text{ mm} \quad B = 300 \text{ mm} \quad t_w = 11 \text{ mm} \quad t_f = 19 \text{ mm} \quad r = 27 \text{ mm} \quad h_w = 262 \text{ mm} \quad d = 208 \text{ mm}$$



**Fig.2.8.19** Dimension notation of I or H shape steel profile

According to relation 4.2 of the fire part of Eurocode 3 (EN 1993-1-2):

$$\varepsilon = 0,85\sqrt{235/f_y} = 0,786 \quad \text{with steel grade S275}$$

On the other hand, according to Table 5.2 of Eurocode 3, part 1-1, the criteria of Class 1 for flange and web are:

- web:  $c/t_w \leq 33\varepsilon \Rightarrow c/t_w \leq 33\varepsilon \Rightarrow d/t_w \leq 33\varepsilon = 25,9$
- flange:  $c/t_f \leq 9\varepsilon \Rightarrow (B/2 - t_w/2 - r)/t_f \leq 9\varepsilon = 7,07$

With the dimensions given above, there are:

- web:  $d/t_w = 208,0/11,0 = 18,9 < 25,9$
- flange:  $(B/2 - t_w/2 - r)/t_f = (300/2 - 11,0/2 - 27)/19 = 6,18 < 7,07$

The column is then classified as Class 1 and can develop full plastic moment resistance.

### 2.8.6.3 Step 3: Determination of the design resistance of the steel column at room temperature

The axial plastic resistance of this column may be obtained on the basis of §4.2.3.1 of Eurocode 3 part 1-2 (EN 1993-1-2).

- From relation 4.3 or relation 4.4 of Eurocode 3 part 1-2:

$$N_{pl,fi,0} = Af_y / \gamma_{M,fi} = 14908 \cdot 275 / 1,0 \approx 4099,7 \text{ kNm}$$

In addition, its non-dimensional slenderness may be determined from relation 6.50 of Eurocode 3, part 1-1:

$$\bar{\lambda}_{fi,0} = \sqrt{\frac{Af_y}{N_{cr}}} = \frac{L_{fi}}{i_z} \frac{1}{93,9\epsilon} = \frac{0,7 \cdot 3,4}{75,8 \cdot 10^{-3}} \cdot \frac{1}{93,9 \sqrt{235/275}} = 0,362$$

It is necessary to point out here that the buckling length of the column is taken as 0,7 of its length according to the design rules given in §4.2.3.2 of the fire part of Eurocode 3 (see also Figure 2.8.18 for illustration).

### 2.8.6.4 Step 4: Degree of utilisation of the column

For this column, only compressive resistance factor is concerned in the determination of its load-bearing capacity. In order to apply the tabulated data provided in the document relative to the basic design methods of the fire part of Eurocode 3, the specific degree of utilisation should be calculated as follows:

$$\mu_0 = \frac{N_{fi,d,t}}{N_{pl,fi,0}} = \frac{1870,7}{4099,7} = 0,456$$

For this steel member, only one degree of utilisation exists because no adaptation factor is applicable to steel columns. In consequence, the critical temperature of this column will remain the same whatever its fire protection state is (unprotected or protected).

### 2.8.6.5 Step 5: Calculation of the critical temperature of the column

The critical temperature of the column cannot be calculated directly from the degree of utilisation using either the relation 4.22 or the reduction factor for the steel strength in Table 2.4.1. The designer has to apply specific tabulated data to get the critical temperature on the basis of the following two parameters:

- degree of utilisation  $\mu_0 = 0,456$
- non-dimensional slenderness of the column in the fire situation but at instant 0  $\bar{\lambda}_{fi,0} = 0,362$

On the basis of the tabulated data given in the document relative to the basic design methods in Table 5.2 (EN 1993-1-1), the interpolation is needed on the one hand between  $\mu_0=0,44$  and  $\mu_0=0,46$  and on the other hand between  $\bar{\lambda}_{fi,0} = 0,2$  and  $\bar{\lambda}_{fi,0} = 0,4$ , one can then obtain  $\theta_{cr} \approx 560$  °C (see Figure 2.8.20).

$\bar{\lambda}_{fi,0}$	0.0	0.2	0.4	0.6	0.8	1.0	1.2	1.4	1.6	1.8	2.0
$\mu_0$	...	...	...	...	...	...	...	...	...	...	...
0.40	629	603	578	544	499						
0.42	621	595	569	535	477						
0.44	613	588	561	525	455						
0.46	604	581	553	516	433						
0.48	597	573	545	506	411						
0.50	590	566	536	494	367						
0.52	584	559	528	477							

$\theta_{cr} \approx 560 \text{ } ^\circ\text{C}$

Fig.2.8.20 Application of tabulated data to determine the critical temperature of the column

### 2.8.6.6 Step 6a: Calculation of the section factor of the unprotected steel column

The section factor of four sides exposed and unprotected HEB300 is  $A_m/V=116 \text{ m}^{-1}$ . The box value of the section factor is  $A_m/V=80 \text{ m}^{-1}$ . The correction factor for the shadow effect may be determined according to the relation 4.26a as follows:

$$k_{sh} = 0,9 \left( \frac{A_m}{V} \right)_b / \frac{A_m}{V} = 0,9 \cdot 80 / 116 \approx 0,621$$

### 2.8.6.7 Step 7a: Calculation of the heating of the unprotected steel column

The heating of the column can then be obtained from the relation 4.25 of the fire part of Eurocode 3 given below:

$$\Delta\theta_{a,t} = \frac{k_{sh}}{c_a \rho_a} \frac{A_m}{V} h_{net,d} \Delta t$$

If this relation is applied to the above beam with following assumption:

- Time interval: 3 seconds (0,05 minutes)
- Constant values for  $\rho_a$  and  $c_a$ :  $\rho_a=7850 \text{ kg/m}^3$  and  $c_a=600 \text{ J/kgK}$

it becomes:

$$\Delta\theta_{a,t} = \frac{k_{sh}}{c_a \rho_a} \frac{A_m}{V} h_{net,d} \Delta t = \frac{0,621}{600 \cdot 7850} \cdot 116 h_{net,d} \cdot 3 = 4,588 \cdot 10^{-5} h_{net,d}$$

However,  $h_{net,d}$  varies with time and is non-linear because:

$$h_{net,d} = h_{net,r} + h_{net,c}$$

with:

$$h_{net,r} = 5,67 \cdot 10^{-8} \Phi \epsilon_{res} \left( (\theta_g + 273)^4 - (\theta_a + 273)^4 \right) = 3,969 \cdot 10^{-8} \left( (\theta_g + 273)^4 - (\theta_a + 273)^4 \right)$$

$$h_{net,c} = \alpha_c (\theta_g - \theta_a) = 25 (\theta_g - \theta_a)$$



$$\theta_g = 20 + 345 \log(8t + 1) \quad (t \text{ in minutes})$$

The most relevant way to deal with  $h_{net,d}$  is to consider a mean value within the time interval  $\Delta t$  (3 seconds in this case) between instant  $t_i$  and  $t_{i+1}$ .

Hence, there is:

$$h_{net,r} = 3,969 \cdot 10^{-8} \left[ \frac{(\theta_{g,i} + 273)^4 + (\theta_{g,i+1} + 273)^4}{2} - (\theta_{a,i} + 273)^4 \right]$$

$$h_{net,c} = 25 \left( \frac{\theta_{g,i} + \theta_{g,i+1}}{2} - \theta_{a,i} \right)$$

The step by step incremental application of the above relations leads to a time duration of 18 minutes and 10 seconds to reach the critical temperature of 560 °C. The accurate calculation with  $c_a$  varying as a function of the temperature gives a time duration of 17 minutes and 54 seconds to reach the critical temperature. In consequence, the fire resistance of this beam, if unprotected, is at least 17 minutes and 54 seconds.

#### 2.8.6.8 Step 6b: Calculation of the section factor of the fire protected steel column

As the column is four sides exposed, its section factor is simply  $A_m/V=80 \text{ m}^{-1}$  because the hollow encasement type of fire protection is adopted for it.

#### 2.8.6.9 Step 7b: Calculation of the heating of the steel column protected with spray material

The heating of the beam can then be obtained from the rules given in §4.2.5.2 of the fire part of Eurocode 3.

In our case, the column is considered to be protected with hollow encasement of boards and thickness 12,5 mm. The thermal properties of this material are:

- Density:  $\rho_p=800 \text{ kg/m}^3$
- Specific heat:  $c_p=1700 \text{ J/kg}^\circ\text{K}$
- Thermal conductivity:  $\lambda_p=0,20 \text{ W/m}^\circ\text{K}$

With the above data, the relation 4.25 of the fire part of Eurocode 3 can be applied. First of all, it is necessary to determine the coefficient  $\phi$ :

$$\phi = \frac{c_p \rho_p}{c_a \rho_a} d_p \frac{A_p}{V} = \frac{800 \cdot 1700}{600 \cdot 7850} \cdot 10 \cdot 10^{-3} \cdot 80 = 0,289$$

With a time interval equal to 3 seconds, the relation 4.25 can then be expressed as:

$$\Delta\theta_{a,t} = \frac{\lambda_p / d_p}{c_a \rho_a} \frac{A_p}{V} \left( \frac{1}{1 + \phi/3} \right) (\theta_{g,t} - \theta_{a,t}) \Delta t - (e^{\phi/10} - 1) \Delta\theta_{g,t} = 7,437 \cdot 10^{-4} (\theta_{g,t} - \theta_{a,t}) - 2,930 \cdot 10^{-2} \Delta\theta_{g,t}$$

To apply the above relation with an Excel sheet, one can obtain very easily that the heating of the steel section HEB300 after a fire exposure of 60 minutes is about 487 °C.

The above calculation can also be made with  $c_a$  varying as function of temperature leading to a heating of 503 °C for the same column.

Also, one can check very easily that the predicted fire protection is enough to ensure the fire resistance requirement of this column.

## 2.9 Conclusions

The worked examples given in this chapter are related to a design procedure on the basis of simple calculation methods. In order to explain this type of design application as clear as possible, all worked examples are elaborated in details with step by step advancement.

The critical temperatures of both unprotected and fire protected steel members are summarized in Table 2.10.1. One can find that the critical temperatures of steel beams vary slightly between unprotected and fire protected cases. This situation can be explained by the influence of temperature gradient which is different between unprotected steel beams and fire protected ones.

The fire resistance of the above steel members if they are not fire protected is summarized in Table 2.10.2. One can find that their fire resistance is between 16,5 and 22 minutes, which does not meet the fire resistance requirement of 60 minutes for this structure.

As far as the fire protection is concerned, two types are adopted: the first one with encasement for all steel beams and the second one with hollow encasement for steel columns for practical reasons. It is shown that the minimum thickness to be applied to these steel members to reach the necessary fire resistance requirement is quite small (see Table 2.10.3).

**Table 2.10.1** Summary of the critical temperatures of all steel members in the worked examples

Steel members	Critical temperature [°C]	
	Bare	Insulated
Secondary beams under end support of continuous slab	667	687
Secondary beams under central support of continuous slab	658	679
Simply supported central main beam	639	606
Central column at ground level	560	560

**Table 2.10.2** Summary of the fire resistance of all unprotected steel members in the worked examples

Steel members	$\theta_{cr}$ [°C]	$k_{sh}A_m/V$ [m <sup>-1</sup> ]	Fire resistance R
Secondary beams under end support of continuous slab	667	131	17 min 00 sec
Secondary beams under central support of continuous slab	658	131	16 min 30 sec
Simply supported central main beam	639	63	23 min 10 sec
Central column at ground level	560	72	17 min 50 sec

**Table 2.10.3** Summary of the fire protection of all steel members in worked examples

Steel members	$\theta_{cr}$ [°C]	Type of protection	Thickness [mm]
Secondary beams under end support of continuous slab	687	Contour encasement	10
Secondary beams under central support of continuous slab	679	Contour encasement	10
Simply supported central main beam	606	Contour encasement	10
Central column at ground level	560	Hollow encasement	12,5



## **CHAPTER 3**

### **EUROCODE 4: DESIGN OF COMPOSITE STEEL AND CONCRETE STRUCTURES. PART 1-2: GENERAL RULES – STRUCTURAL FIRE DESIGN**

**Louis-Guy CAJOT**

ArcelorMittal Research & Development, Esch/Alzette, Grand-Duchy of Luxembourg



## 3.1 Verification of the composite slab

### 3.1.1 Objective

This chapter aims to verify the stability of the composite slab in the fire situation. The slab is continuous on 3 supports and has a span equal to 3m (see Chapter 2 for description of the building). The required fire resistance is R60.

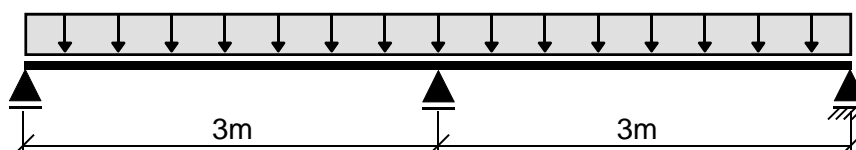


Fig.3.1.1 Static scheme of the floor

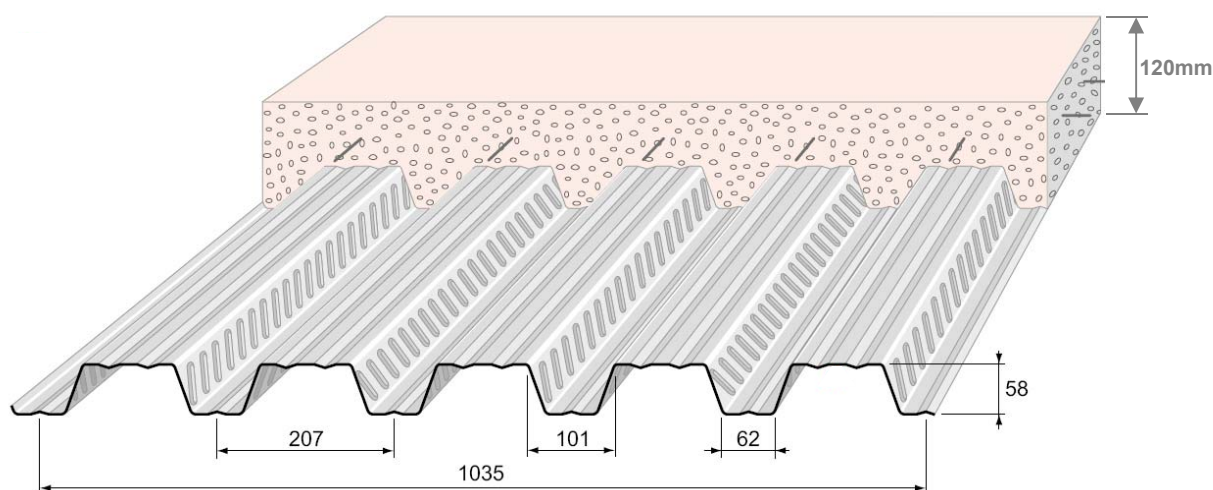


Fig.3.1.2 Dimensions of the slab (COFRAPLUS 60)

### Material characteristics

#### Steel decking

Yield strength:  $f_y = 350 \text{ N/mm}^2$

#### Concrete

Class: C 25/30

Compressive strength:  $f_c = 25 \text{ N/mm}^2$

#### Reinforcing bars

Yield strength:  $f_y = 500 \text{ N/mm}^2$

Mesh ST25:	$A = 2,57 \text{ cm}^2/\text{m}$
Ribs:	1 $\phi$ 8 /rib

### Loads

#### Permanent loads

Steel decking:  $g_{t,k} = 0,085 \text{ kN/m}^2$

Concrete:  $g_{b,k} = 2,03 \text{ kN/m}^2$

Permanent load:  $g_{c,k} = 1,5 \text{ kN/m}^2$

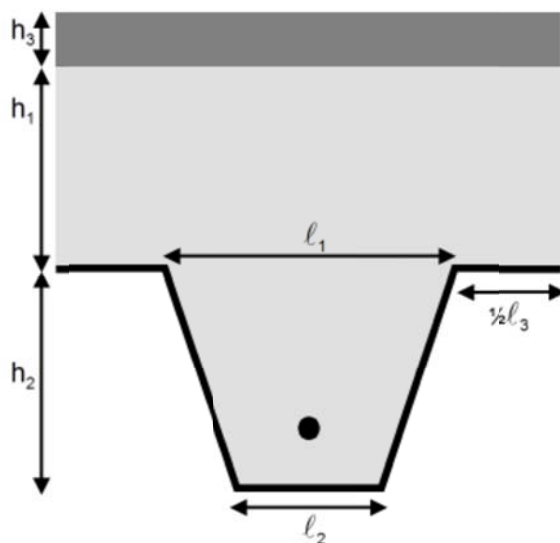
#### Variable load

Variable load:  $q_k = 4,0 \text{ kN/m}^2$

### 3.1.2 Fire resistance of the composite slab

The composite slab is designed for fire according to the EN 1994-1-2, §4.3 and Annex D.

#### 3.1.2.1 Geometric parameters and field of application (§4.3.2 - Figure 4.1, EN 1994-1-2)



**Fig.3.1.3** Transversal dimensions of the composite slab

The dimensions of the composite slab are as follows:

$$h_1 = 62 \text{ mm} \quad h_2 = 58 \text{ mm} \quad h_3 = 0$$

$$l_1 = 101 \text{ mm} \quad l_2 = 62 \text{ mm} \quad l_3 = 106 \text{ mm}$$

Thickness of the steel decking is 0,75 mm.



**Table 3.1.1** Application field for unprotected composite slabs for normal weight concrete and trapezoidal steel decking profiles (Annex D - Table D.7, EN 1994-1-2)

Trapezoidal steel decking profiles [mm]	Existing geometric parameters [mm]	Condition fulfilled?
$80 \leq \ell_1 \leq 155$	$\ell_1 = 101$	OK
$32 \leq \ell_2 \leq 132$	$\ell_2 = 62$	OK
$40 \leq \ell_3 \leq 115$	$\ell_3 = 106$	OK
$50 \leq h_1 \leq 125$	$h_1 = 62$	OK
$50 \leq h_2 \leq 100$	$h_2 = 58$	OK

All the conditions are fulfilled, the method could be applied.

### 3.1.2.2 Fire resistance according to thermal insulation (Annex D - §D.1)

The thermal insulation criterion “I” is defined as follows:

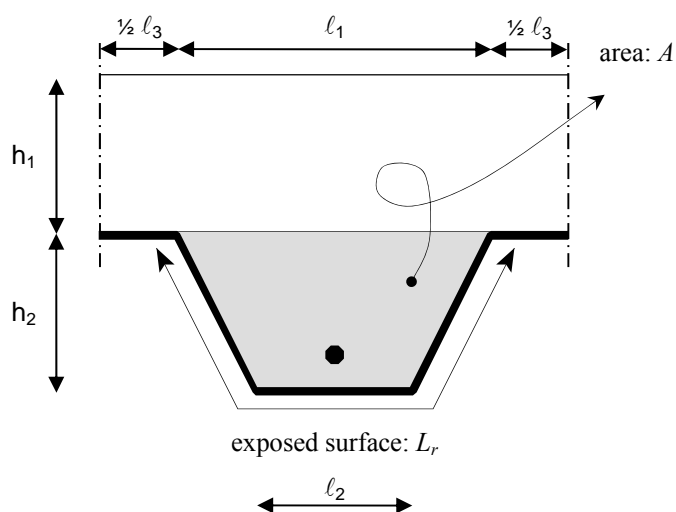
- The average temperature rise of the unexposed face does not exceed 140°C.
- The maximum temperature rise is limited to 180°C.

The corresponding fire resistance criterion “I” (given in minutes) may be determined according to the following relation:

$$t_i = a_0 + a_1 h_1' + a_2 \Phi + a_3 \frac{A}{L_r} + a_4 \frac{1}{\ell_3} + a_5 \frac{A}{L_r} \frac{1}{\ell_3}$$

with  $h_1' = h_1 + h_3$  ( $h_3$  = thickness of the screed)

The rib geometry factor  $A/L_r$  might be compared to the massivity factor of the beams.



**Fig.3.1.4** Definition of the rib geometry factor

The rib geometry factor is determined as follows:

$$\frac{A}{L_r} = \frac{h_2 \left( \frac{\ell_1 + \ell_2}{2} \right)}{\ell_2 + 2 \sqrt{h_2^2 + \left( \frac{\ell_1 - \ell_2}{2} \right)^2}} = \frac{58 \cdot \left( \frac{101 + 62}{2} \right)}{62 + 2 \cdot \sqrt{58^2 + \left( \frac{101 - 62}{2} \right)^2}} = 25,6 \text{ mm}$$

The view factor  $\Phi$  takes into account the shadow effect from the rib to the upper flange of the steel decking:

$$\Phi = \frac{\sqrt{h_2^2 + \left( \ell_3 + \frac{\ell_1 - \ell_2}{2} \right)^2} - \sqrt{h_2^2 + \left( \frac{\ell_1 - \ell_2}{2} \right)^2}}{\ell_3} = \frac{\sqrt{58^2 + \left( 106 + \frac{101 - 62}{2} \right)^2} - \sqrt{58^2 + \left( \frac{101 - 62}{2} \right)^2}}{106} = 0,727$$

The  $a_i$  coefficients for normal weight concrete are given in Table 3.1.2.

**Table 3.1.2** Coefficients for determination of the fire resistance with respect to thermal insulation “I” (Annex D - Table D.1, EN 1994-1-2)

	$a_0$	$a_1$	$a_2$	$a_3$	$a_4$	$a_5$
	[min]	[min/mm]	[min]	[min/mm]	[mm·min]	[min]
Normal weight concrete	-28,8	1,55	-12,6	0,33	-735	48

With these parameters, is obtained:

$$t_i = (-28,8) + 1,55 \cdot 62 + (-12,6) \cdot 0,727 + 0,33 \cdot 25,6 + (-735) \cdot \frac{1}{106} + 48 \cdot 25,6 \cdot \frac{1}{106} = 71 \text{ min} > 60 \text{ min}$$

The slab is considered sufficient to guarantee the thermal insulation for a standard fire of 60 minutes.

**Note:**

The simplified method described in the EN 1994-1-2, Annex D, §D.4, allows to determine the fire resistance with respect to the thermal insulation criterion by calculating the minimal effective thickness of the slab  $h_{\text{eff}}$ .

For  $h_2/h_1 \leq 1,5$  and  $h_1 > 40\text{mm}$ ,

$$h_{\text{eff}} = h_1 + 0,5h_2 \left( \frac{\ell_1 + \ell_2}{\ell_1 + \ell_3} \right) = 62 + 0,5 \cdot 58 \cdot \left( \frac{101 + 62}{101 + 106} \right) = 85 \text{ mm}$$

The relation between the fire resistance with respect to the thermal insulation criterion and the minimum effective slab thickness is given in Table 3.1.3. For  $h_3 = 0$ , the simplified method gives a fire resistance of 60 minutes (I 60).

**Table 3.1.3** Minimum effective thickness as a function of the standard fire resistance  
(Annex D - Table D.6, EN 1994-1-2)

Standard fire resistance	$h_{eff}$ [mm]
I 30	60- $h_3$
I 60	80- $h_3$
I 90	100- $h_3$
I 120	120- $h_3$
I 180	150- $h_3$
I 240	175- $h_3$

→  $h_3 = 0$ ;  $h_{eff} = 85\text{mm}$

### 3.1.2.3 Verification of the bearing capacity

#### Calculation of the sagging moment resistance

The sagging moment resistance may be determined by the following equation (§4.3.1, Eqn.(4.3), EN 1994-1-2):

$$M_{fi,t,Rd} = \sum_{i=1}^n A_i z_i k_{y,\theta,i} \left( \frac{f_{y,i}}{\gamma_{M,fi}} \right) + \alpha_{stab} \sum_{j=1}^m A_j z_j k_{c,\theta,j} \left( \frac{f_{c,j}}{\gamma_{M,fi,c}} \right)$$

To determine the reduction factors  $k_{y,\theta}$  for the upper flange, the web and the lower flange of the steel decking, it is necessary to know the temperature distribution in the steel decking. These temperatures are calculated from the following equation (Eqn.(D.4), §D.2, EN 1994-1-2):

$$\theta_a = b_0 + b_1 \frac{1}{\ell_3} + b_2 \frac{A}{L_r} + b_3 \Phi + b_4 \Phi^2$$

The coefficients  $b_i$  are given in Table 3.1.4:

**Table 3.1.4** Coefficients for the determination of the temperatures of the parts of the steel decking  
(Annex D - Table D.2, EN 1994-1-2)

	Fire resistance [min]	Part of the steel decking	$b_0$	$b_1$	$b_2$	$b_3$	$b_4$
			[°C]	[°C·mm]	[°C/mm]	[°C]	[°C]
Normal weight concrete	60	Lower flange	951	-1197	-2,32	86,4	-150,7
		Web	661	-833	-2,96	537,7	-351,9
		Upper flange	340	-3269	-2,62	1148,4	-679,8
	90	Lower flange	1018	-839	-1,55	65,1	-108,1
		Web	816	-959	-2,21	464,9	-340,2
		Upper flange	618	-2786	-1,79	767,9	-472,0
	120	Lower flange	1063	-679	-1,13	46,7	-82,8
		Web	925	-949	-1,82	344,2	-267,4
		Upper flange	770	-2460	-1,67	592,6	-379,0

For the different parts of the steel decking, the temperatures at 60 minutes are:

Lower flange:

$$\theta_a = 951 - 1197 \cdot \frac{1}{106} - 2,32 \cdot 25,6 + 86,4 \cdot 0,727 - 150,7 \cdot 0,727^2 = 863^\circ\text{C}$$

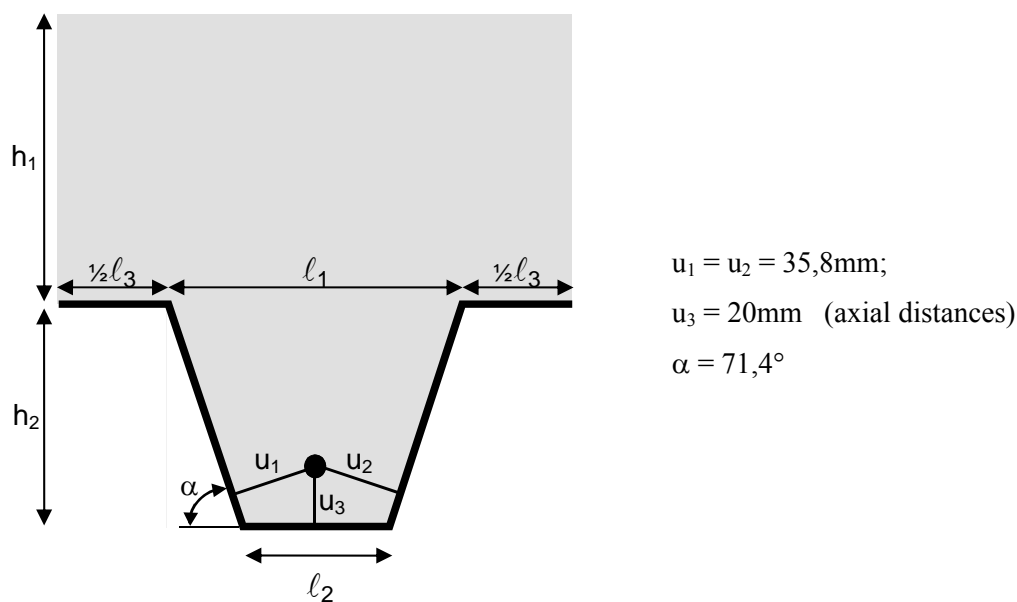
Web:

$$\theta_a = 661 - 833 \cdot \frac{1}{106} - 2,96 \cdot 25,6 + 537,7 \cdot 0,727 - 351,9 \cdot 0,727^2 = 782^\circ\text{C}$$

Upper flange:

$$\theta_a = 340 - 3269 \cdot \frac{1}{106} - 2,62 \cdot 25,6 + 1148,4 \cdot 0,727 - 679,8 \cdot 0,727^2 = 718^\circ\text{C}$$

For each rib, a reinforcing bar of diameter  $\phi 8$  is used. The position of the reinforcing bar is shown in Figure 3.1.5.



**Fig.3.1.5** Position of the reinforcing bar

The temperature of the reinforcing bar is determined by the following relation:

$$\theta_s = c_0 + c_1 \frac{u_3}{h_2} + c_2 z + c_3 \frac{A}{L_r} + c_4 \alpha + c_5 \frac{1}{l_3}$$

with

$$\frac{1}{z} = \frac{1}{\sqrt{u_1}} + \frac{1}{\sqrt{u_2}} + \frac{1}{\sqrt{u_3}} = \frac{1}{\sqrt{35,8}} + \frac{1}{\sqrt{35,8}} + \frac{1}{\sqrt{20}} \Rightarrow z = 1,79\text{mm}^{0,5}$$

The coefficients  $c_i$  for normal weight concrete are given in Table 3.1.5.

**Table 3.1.5** Coefficients for the determination of the temperatures of the reinforcing bar in the rib  
(Annex D - Table D.3, EN 1994-1-2)

	Fire resistance [min]	$c_0$ [°C]	$c_1$ [°C]	$c_2$ [°C/mm <sup>0.5</sup> ]	$c_3$ [°C/mm]	$c_4$ [°C/°]	$c_5$ [°C]
Normal weight concrete	60	1191	-250	-240	-5,01	1,04	-925
	90	1342	-256	-235	-5,30	1,39	-1267
	120	1387	-238	-227	-4,79	1,68	-1326

With these parameters, the temperature of the reinforcing bar is:

$$\theta_s = 1191 - 250 \cdot \frac{20}{58} - 240 \cdot 1,79 - 5,01 \cdot 25,6 + 1,04 \cdot 71,4 - 925 \cdot \frac{1}{106} = 612^\circ\text{C}$$

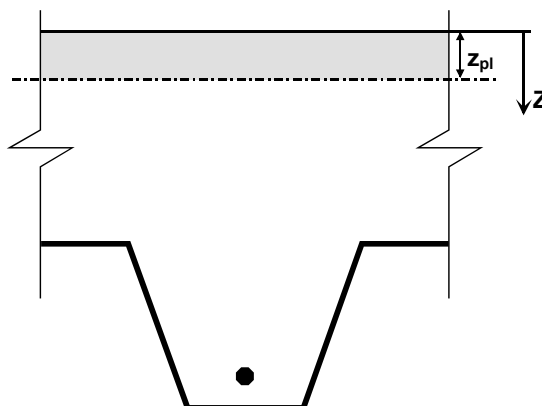
For the steel decking, the reduction factors  $k_{y,i}$  according to the temperature are given in Table 3.2 of the EN 1994-1-2. Those related to the reinforcing bars are given in Table 3.4, EN 1994-1-2.

The contributions to the bearing capacity of the different parts of the steel decking and the reinforcing bar could be now calculated. They are given in Table 3.1.6.

**Table 3.1.6** Reduction factors and bearing capacities

	Temperature $\theta_i$ [°C]	Reduction factor $k_{y,i}$ [-]	Partial area $A_i$ [cm <sup>2</sup> ]	$f_{y,i,\theta}$ [kN/cm <sup>2</sup> ]	$F_i$ [kN]
Lower flange	863	0,078	0,465	2,74	1,274
Web	782	0,131	0,918	4,60	4,221
Upper flange	718	0,209	0,795	7,31	5,813
Reinforcing bar in the rib	612	0,367	0,503	18,34	9,22

The plastic neutral axis is calculated by the equilibrium of the horizontal forces (§4.3, Eqn.(4.2), EN 1994-1-2). For one rib, is obtained:



**Fig.3.1.6** Position of the plastic neutral axis

$$z_{pl} = \frac{\sum F_i}{\alpha_{slab} (\ell_1 + \ell_3) f_c} = \frac{1,274 + 4,221 + 5,813 + 9,22}{0,85 \cdot (101 + 106) \cdot 25 \cdot 10^{-3}} = 4,7 \text{ mm}$$

The moment resistance of each part of the rib is given in Table 3.1.7.

**Table 3.1.7** Moment resistance of the parts of the rib

	$F_i$ [kN]	$z_i$ [cm]	$M_i$ [kNcm]
Lower flange	1,274	11,96	15,245
Web	4,221	9,10	38,410
Upper flange	5,813	6,16	35,820
Reinforcing bar in the rib	9,22	10,0	92,2
Concrete	-20,527	0,23	-4,79

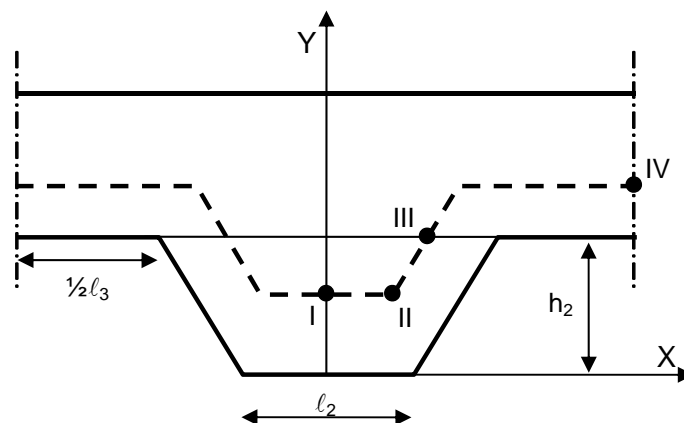
The sagging moment resistance of the composite slab, for a rib width of 207mm, is given by  $\Sigma M_i = 176,9 \text{ kNcm}$ .

Then, for a slab width equal to 1m,

$$M_{fi,Rd}^+ = \frac{\sum M_i}{\text{rib width}} = \frac{1,769}{0,207} = 8,5 \text{ kNm/m}$$

### Calculation of the hogging moment resistance

The hogging moment resistance of the slab is calculated by considering a reduced cross section established on the basis of the isotherm for the limit temperature  $\theta_{lim}$  schematised by means of 4 characteristic points (Eqns. D8 to D14, Annex D.3(5), EN 1994-1-2) (see Figure 3.1.7).



**Fig.3.1.7** Schematisation isotherm

The limit temperature  $\theta_{lim}$  is given by:

$$\theta_{lim} = d_0 + d_1 N_s + d_2 \frac{A}{L_r} + d_3 \Phi + d_4 \frac{1}{\ell_3}$$

with  $N_s = 26,6$  kN is the normal force in the upper reinforcing bar (see Table 3.1.10).

The values of the  $d_i$  factors are given in Table 3.1.8.

**Table 3.1.8** Coefficients for the determination of the limiting temperature  
(Annex D - Table D.4, EN 1994-1-2)

	Fire resistance [min]	$d_0$ [°C]	$d_1$ [°C].N	$d_2$ [°C].mm	$d_3$ [°C]	$d_4$ [°C].mm
Normal weight concrete	60	867	$-1,9 \cdot 10^{-4}$	-8,75	-123	-1378
	90	1055	$-2,2 \cdot 10^{-4}$	-9,91	-154	-1990
	120	1144	$-2,2 \cdot 10^{-4}$	-9,71	-166	-2155

With these parameters, the limit temperature is:

$$\theta_{lim} = 867 - 1,9 \cdot 10^{-4} \cdot 26600 - 8,75 \cdot 25,6 - 123 \cdot 0,727 - 1378 \cdot \frac{1}{106} = 535^\circ\text{C}$$

The parameter  $z$  of the formula D.9 (EN 1994-1-2) is obtained from the equation for the determination of the temperature of the reinforcing bar, assuming that  $u_3/h_2 = 0,75$  and  $\theta_s = \theta_{lim}$ .

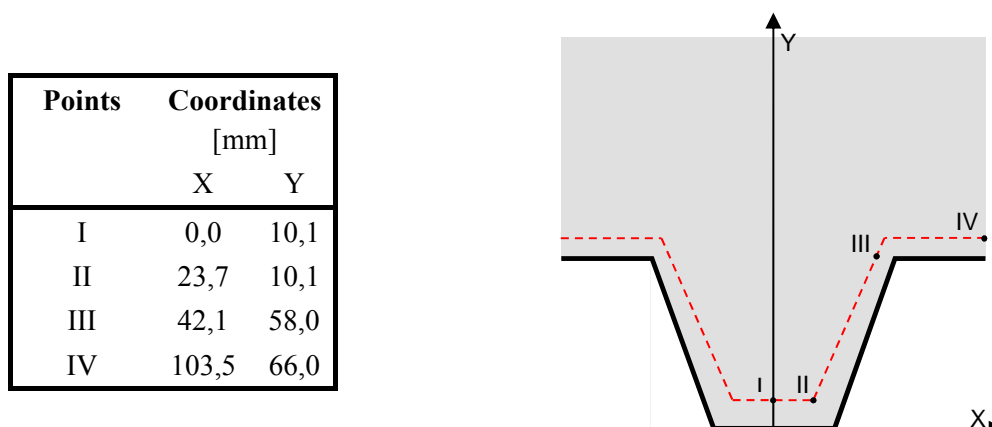
$$\theta_{lim} = c_0 + 0,75c_1 + c_2 z + 25,6c_3 + 71,4c_4 + c_5 \frac{1}{106} \quad \Rightarrow$$

$$z = \frac{\theta_{lim} - c_0 - 0,75c_1 - 25,6c_3 - 71,4c_4 - c_5 \frac{1}{106}}{c_2} =$$

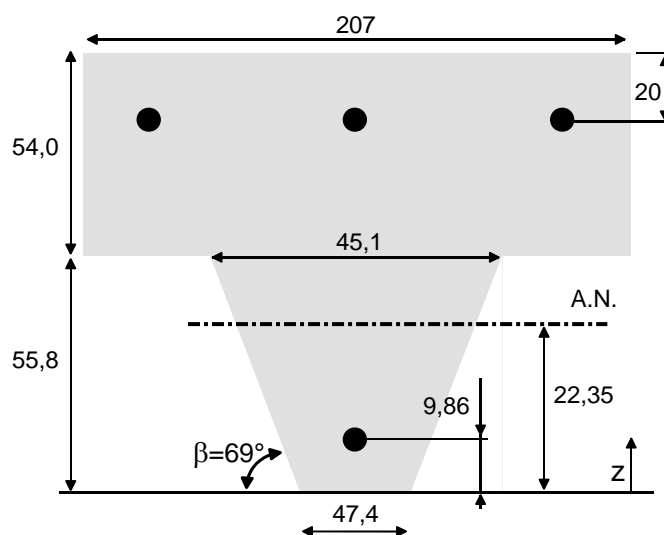
$$= \frac{535 - 1191 + 0,75 \cdot 250 + 25,6 \cdot 5,01 - 71,4 \cdot 1,04 + 925 \cdot \frac{1}{106}}{(-240)} = 1,69 \text{ mm}^{0,5}$$

The coordinates of the 4 characteristic points are determined by the formulae D.8 to D.14 (EN 1994-1-2) and are given in Table 3.1.9.

**Table 3.1.9** Coordinates of the points of the isotherm



The reduced cross section becomes:



**Fig.3.1.8** Coordinates of the points of the isotherm

The bearing capacity of the reinforcing bars is given in Table 3.1.10.

**Table 3.1.10** Reduction factors and bearing capacity of the reinforcing bars

Temperature $\theta_i$ [°C]	Reduction factor $k_{y,i}$ [-]	Partial area $A_i$ [cm <sup>2</sup> ]	$f_{y,i,\theta}$ [kN/cm <sup>2</sup> ]	$F_i$ [kN]
mesh ST25 $\theta < \theta_{lim}$	1	0,532	50	26,60

The horizontal equilibrium gives:



$$\sum F_i = \left( \frac{1}{t g \beta} z_{pl}^2 + 47,4 z_{pl} \right) 0,85 f_c$$

For 1 rib, the plastic neutral axis is  $z_{pl} = 22,35\text{mm}$

The moment resistance for each part of the rib is given in Table 3.1.11.

**Table 3.1.11** Moment resistance of the parts of the rib

	$F_i$ [kN]	$z_i$ [cm]	$M_i$ [kNcm]
mesh ST25	26,60	8,9	239,01
concrete rib	-26,60	4,5	-120,32

The hogging moment resistance of the composite slab, for a rib width of 207mm, is given by  $\Sigma M_i = 118,7\text{kNcm}$ .

Then, for a slab width equal to 1m,

$$M_{fi,Rd}^- = \frac{\sum M_i}{\text{rib width}} = \frac{1,187}{0,207} = 5,734 \text{ kNm/m}$$

For a slab width equal to 1m, the bearing capacity may be deduced from the sagging and hogging moment by the following relation:

$$p_{fi,Rd} = \frac{2M_{fi,Rd}^- + 4M_{fi,Rd}^+}{\ell^2} + \frac{2}{\ell^2} \sqrt{(M_{fi,Rd}^- + 2M_{fi,Rd}^+)^2 - M_{fi,Rd}^-^2}$$

$$p_{fi,Rd} = \frac{2 \cdot 5,734 + 4 \cdot 8,5}{3^2} + \frac{2}{3^2} \cdot \sqrt{(5,734 + 2 \cdot 8,5)^2 - 5,734^2} = 9,98 \text{ kN/m} \quad \text{for a slab width of 1 m}$$

The applied load is determined by the combination of actions in accidental situations:

$$E_{fi,d} = G_k + \psi_{1,1} Q_{k,1} \quad (\text{EN 1991-1-2 } \S 4.3.1(2)), (\text{EN 1990 - Table A.1.1})$$

$$p_{fi,d} = 1,0(0,085 + 2,03 + 1,5) + 0,64 = 6,02 \text{ kN/m}^2$$

$$p_{fi,Rd} = 9,98 \text{ kN/m}^2 > p_{fi,d} = 6,02 \text{ kN/m}^2$$

→ The slab has a fire resistance of 60 minutes.

## 3.2 Verification of the statically determined composite beam

### 3.2.1 Objective

This section aims to verify the fire resistance R60 (with protection material) of a simply supported isostatic composite beam of an office building in fire situation. The beam is submitted to a load  $G_k$  uniformly distributed, and a variable load  $Q_k$ .

This beam represents the central support of the slab uniformly loaded on 3 supports. The reaction on the supports is equal to  $1,25 P\ell$ , with  $\ell$  equal to 3m.

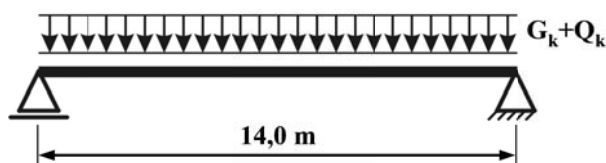


Fig.3.2.1 Statically determined system

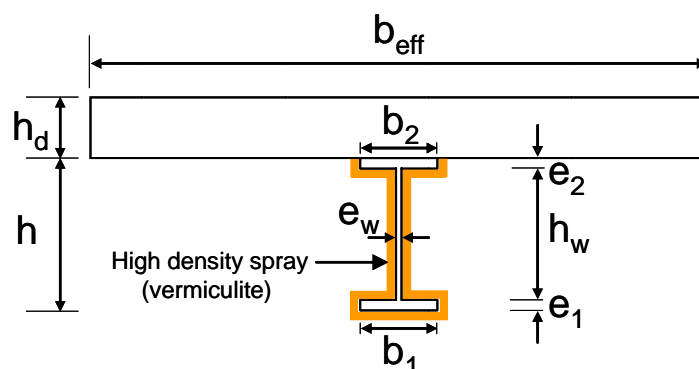


Fig.3.2.2 Transversal section

### Geometrical characteristics and material properties

#### Beam

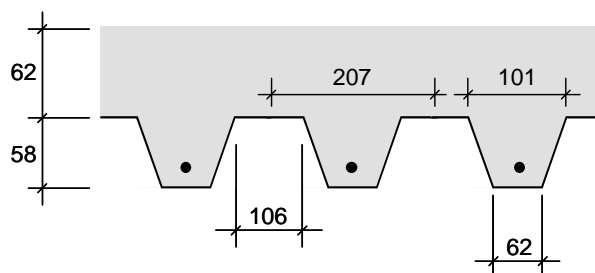
Profile:	Rolled section IPE450
Steel grade:	S355
Height:	$h = 450$ mm
Web height:	$h_w = 420,8$ mm
Depth:	$b_1 = b_2 = b = 190$ mm
Web thickness:	$e_w = t_w = 9,4$ mm
Flange thickness:	$e_f = e_1 = e_2 = t_f = 14,6$ mm
Steel section area:	$A_a = 9880$ mm <sup>2</sup>
Yield strength:	$f_{y,a} = 355$ N/mm <sup>2</sup>

### Fire protection

Material:	Sprayed product
Thickness:	$d_p = 15\text{ mm}$
Thermal conductivity:	$\lambda_p = 0,12\text{ W/m}^\circ\text{K}$
Specific heat:	$c_p = 1100\text{ J/kg}^\circ\text{K}$
Density:	$\rho_p = 550\text{ kg/m}^3$

### Slab

Concrete classe:	C 25/30
Height:	$h_d = 120\text{ mm}$
Effective width:	$b_{\text{eff}} = 3000\text{ mm}$
Compressive strength:	$f_c = 25\text{ N/mm}^2$
Concrete area:	$A_b = (62 \cdot 207) + 0,5 \cdot 58 \cdot (101 + 62) = 17561\text{ mm}^2$



**Fig.3.2.3** Cross section of the slab

### Steel decking

Yield strength:	$f_{y,p} = 350\text{ kN/m}^2$
-----------------	-------------------------------

### Connectors

Number:	$n = 136$
Diameter:	$d = 19\text{ mm}$
Ultimate strength:	$f_u = 450\text{ N/mm}^2$

### Loads

#### Permanent Load

Steel decking:	$g_{t,k} = 0,085\text{ kN/m}^2$
Concrete:	$g_{b,k} = 2,03\text{ kN/m}^2$
Permanent load:	$g_{c,k} = 1,5\text{ kN/m}^2$
Self-weight of the profile :	$G_{a,k} = 0,776\text{ kN/m}$

#### Variable load

Variable load:	$q_k = 4,0\text{ kN/m}^2$ (EN 1991-1-1 , Tables 6.1 and 6.2)
----------------	--

### 3.2.2 Fire resistance of the composite beam

#### 3.2.2.1 Mechanical actions in fire situation (EN 1990, §6.4.3.3)

The applied load is determined by the combination of actions in accidental situations:

$$F_{fi,d} = 1,25[(g_{k,1} + \psi_{2,1}q_{k,1})\ell] + G_{a,k} = 1,25[(3,62 + 0,6 \cdot 4) \cdot 3] + 0,776 = 23,332 \text{ kN/m}$$

The design bending moment in fire situation is:

$$M_{fi,Ed} = \frac{F_{fi,d}L^2}{8} = \frac{23,332 \cdot 14^2}{8} = 571,6 \text{ kNm}$$

#### 3.2.2.2 Classification of the section in fire situation (EN 1993-1-2, §4.2.2)

$$\varepsilon = 0,85 \sqrt{\frac{235}{f_y}} = 0,69$$

- Web classification (EN 1993-1-1, Table 5.2)

$$\frac{d}{t_w} = \frac{378,8}{9,4} = 40,3 \leq 72\varepsilon = 49,8$$

→ web Class 1

- Classification of the steel flange in compression (EN 1994-1-2, §4.3.4.1.2(2))

For simply supported beams, the steel flange in compression may be treated as Class 1, provided it is well connected to the concrete slab.

→ flange Class 1

Moreover, as the web is in tension and the flange is connected to the slab, Class 1 is always considered.

#### 3.2.2.3 Temperature calculation in the cross section (EN 1994-1-2)

When a steel-concrete composite beam with no concrete encasement is submitted to ISO-fire, its heating is assumed to be uniform on its length and could be determined by considering different parts for the steel section and the concrete slab. In our example, the steel profile is split into three parts: the bottom flange, the web and the upper flange (§4.3.4.2, EN 1994-1-2).

The different steps to calculate the temperatures of each parts of the beam are the following:

- Determination of the section factor,
- Determination of the corresponding temperature.

The protection material is directly applied to the surface of the steel section. The section factors are calculated by the following way (§4.3.4.2.2, EN 1994-1-2):

Bottom flange (Eqn. (4.9a), EN 1994-1-2)

$$\left(\frac{A_{p,i}}{V_i}\right) = \frac{2(b_1 + e_1)}{b_1 e_1} = \frac{2(0,19 + 0,0146)}{0,19 \cdot 0,0146} = 147,5 \text{ m}^{-1}$$

### Web

$$\left(\frac{A_{p,i}}{V_i}\right) = \frac{2h_w}{h_w e_w} = \frac{2 \cdot 0,4208}{0,4208 \cdot 0,0094} = 212,8 \text{ m}^{-1}$$

If the beam height  $h$  does not exceed 500mm, the temperature of the web may be taken as equal to that of the lower flange (4.3.4.2.2(10), EN 1994-1-2).

### Upper flange

As less than 85% of the upper flange of the steel profile is in contact with the concrete slab (Eqn.(4.9c), EN 1994-1-2):

$$\left(\frac{A_{p,i}}{V_i}\right) = \frac{2(b_2 + e_2)}{b_2 e_2} = \frac{2(0,19 + 0,0146)}{0,19 \cdot 0,0146} = 147,5 \text{ m}^{-1}$$

The steel temperatures are determined according to the following equation (§4.3.4.2.2(6), EN 1994-1-2):

$$\Delta\theta_{a,t} = \left[ \left( \frac{\lambda_p / d_p}{c_a \rho_a} \right) \left( \frac{A_{p,i}}{V_i} \right) \left( \frac{I}{I + w / 3} \right) (\theta_t - \theta_{a,t}) \Delta t \right] - \left[ (e^{w/10} - 1) \Delta\theta_t \right]$$

with:

- $c_a$  specific heat of the steel; varying according to the steel temperature [J/(kg.K)] (§3.3.1(4), EN 1994-1-2)
- $\rho_a$  density of the steel [kg/m<sup>3</sup>] (§ 3.4(1), EN 1994-1-2)
- $\lambda_p$  thermal conductivity of the fire protection material [W/m<sup>2</sup>K]
- $d_p$  thickness of the fire protection material [m]
- $A_{p,i}$  is the area of the inner surface of the fire protection material per unit length of the part  $i$  of the steel member [m<sup>2</sup>/m]
- $V_i$  volume of the part  $i$  of the steel cross section per unit length [m<sup>3</sup>/m]
- $A_{p,i}/V_i$  section factor of the part  $i$  of the insulated steel cross-section [m<sup>-1</sup>]
- $\Delta t$  time interval (less than 5sec) [s]

$$w = \left( \frac{c_p \rho_p}{c_a \rho_a} \right) d_p \left( \frac{A_{p,i}}{V_i} \right)$$

with

- $c_p$  specific heat of the fire protection material [J/kg<sup>o</sup>K]
- $\rho_p$  density of the fire protection material [kg/m<sup>3</sup>]

**Table 3.2.1** Temperature evolution in the different parts of the steel profile

Steel temperatures after 60 min of fire exposure [°C]	
Upper flange	480
Web	588
Lower flange	480

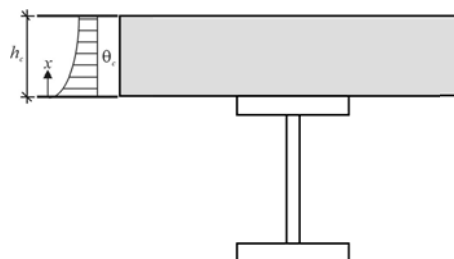
### Temperatures in the concrete slab

The temperatures are not uniformly distributed in the concrete slab. Therefore, the compressive strength of the concrete varies within the thickness. For temperatures less than 250°C, the compressive strength of the concrete is not reduced. Above that temperature, the compressive strength has to be corrected by the reduction factor  $k_{c,\theta}$  (EN 1994-1-2).

The temperature distribution in the concrete slab can be determined by Table 3.2.2.

**Table 3.2.2** Temperature distribution in a full slab of 100mm (EN 1994-1-2, Annex D.3, Table D.5)

height x [mm]	Temperature $\theta_c$ [°C] after a fire duration of					
	30'	60'	90'	120'	180'	240'
5	535	705				
10	470	642	738			
15	415	581	681	754		
20	350	525	627	697		
25	300	469	571	642	738	
30	250	421	519	591	689	740
35	210	374	473	542	635	700
40	180	327	428	493	590	670
45	160	289	387	454	549	645
50	140	250	345	415	508	550
55	125	200	294	369	469	520
60	110	175	271	342	430	495
80	80	140	220	270	330	395
100	60	100	160	210	260	305



### 3.2.2.4 Verification of the resistance by the moment resistance method (EN 1994-1-2, Annex E)

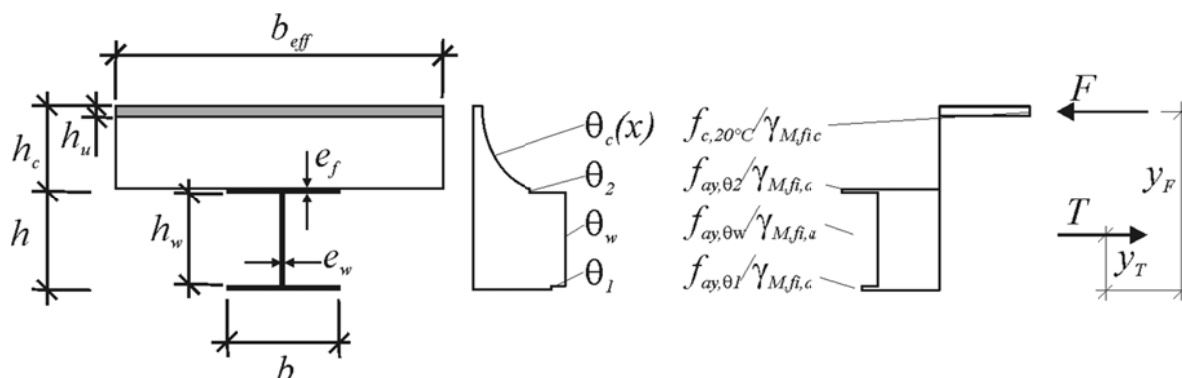


Fig.3.2.4 Principle of the calculation of the resistant moment

Before the calculation of the fire resistance of the beam, it is necessary to calculate the yield strength  $f_{ay,\theta}$  (effective strength) of the three parts of the steel profile, in function of the temperatures given in Table 3.2.3.

After calculation, the values are:

**Table 3.2.3** Effective resistance of the steel profile after 60 minutes of fire exposure (§3.2.1, Table 3.2, EN 1994-1-2)

	$\theta_{a,max,60}$ [°C]	$k_{y,\theta}$ [-]	$f_{ay,\theta}$ [N/mm <sup>2</sup> ]
Upper flange	480	0,824	292,5
Web	588	0,507	179,9
Lower flange	480	0,824	292,5

#### Calculation of the sagging moment resistance $M_{fi,Rd}^+$

The steel profile is subjected to a tensile force T which could be calculated by the following way (E.1(1), EN 1994-1-2):

$$T = \frac{(f_{ay,\theta_1} b e_f + f_{ay,\theta_w} h_w e_w + f_{ay,\theta_2} b e_f)}{\gamma_{M,fi,a}}$$

$$T = \frac{(292,5 \cdot 190 \cdot 14,6 + 179,9 \cdot 420,8 \cdot 9,4 + 292,5 \cdot 190 \cdot 14,6)}{1,0} = 2334,096 \text{ kN}$$

The location of the tensile force from the edge of the bottom flange is given by the following equation:

$$y_T = \frac{f_{ay,\theta_1} \left( \frac{b e_f^2}{2} \right) + f_{ay,\theta_w} (h_w e_w) \left( e_f + \frac{h_w}{2} \right) + f_{ay,\theta_2} (b e_f) \left( h - \frac{e_f}{2} \right)}{T \gamma_{M,fi,a}}$$

$$y_T = \frac{292,5 \cdot \left( \frac{190 \cdot 14,6^2}{2} \right) + 180,0(420,8 \cdot 9,4) \left( 14,6 + \frac{420,8}{2} \right) + 292,5 \cdot (190 \cdot 14,6) \left( 450 - \frac{14,6}{2} \right)}{2334,1 \cdot 10^3 \cdot 1} = 222,6 \text{ mm}$$

In case of a symmetric beam heated symmetrically, the tensile force is applied at mid-height of the steel profile ( $y_T = 225 \text{ mm}$ ).

In addition, it has to be checked whether the value of the tensile force does not exceed the shear resistance of the connectors (E1(2)):

$$T \leq NP_{fi,Rd}$$

Where:

- N is the number of connectors in the critical length of the beam,
- $P_{fi,Rd}$  is the design shear resistance of one connector in fire situation.

To determine the shear resistance of one connector in fire situation, different parameters should be calculated: the reduction factors  $k_{u,\theta}$  and  $k_{c,\theta}$ , and the shear resistance at ambient temperature  $P_{Rd,1}$  and  $P_{Rd,2}$  of the connectors.

The temperatures  $\theta_v$  [ $^{\circ}\text{C}$ ] of the connectors and  $\theta_c$  [ $^{\circ}\text{C}$ ] of the concrete, needed to calculate the reduction factors  $k_{u,\theta}$  and  $k_{c,\theta}$  may be taken as 80% and 40% respectively of the temperature of the upper flange of the steel profile (§4.3.4.2.5 (2), EN 1994-1-2).

According to the Table 3.2 and Table 3.3 of EN 1994-1-2, the reduction factors  $k_{u,\theta}$  and  $k_{c,\theta}$  are the following:

$$\theta_v = 0,8 \cdot 480 = 384,1^{\circ}\text{C} \quad \Rightarrow k_{u,\theta} = 1,04$$

$$\theta_c = 0,4 \cdot 480 = 192^{\circ}\text{C} \quad \Rightarrow k_{c,\theta} = 0,954$$

The shear resistance at ambient temperature of one connector is determined in accordance with EN 1994-1-1 (§6.6.3.1), except that the partial factor  $\gamma_v$  should be replaced by  $\gamma_{M,fi,v}$ :

$$P'_{Rd,1} = 0,8 \frac{f_u}{\gamma_{M,fi,v}} \frac{\pi d^2}{4} = 0,8 \cdot \frac{450}{1,0} \cdot \frac{\pi 19^2}{4} = 102 \text{ kN}$$

$$P'_{Rd,2} = 0,29 \alpha d^2 \frac{\sqrt{f_c E_{cm}}}{\gamma_{M,fi,v}} = 0,29 \cdot 1,0 \cdot 19^2 \cdot \frac{\sqrt{25 \cdot 30500}}{1,0} = 91 \text{ kN}$$

Finally, the shear resistance of the connectors in fire situation corresponds to the smaller of the following values (§4.3.4.2.5, EN 1994-1-2):

$$P_{fi,Rd} = \min \begin{cases} P_{fi,Rd,1} = 0,8 k_{u,\theta} P'_{Rd,1} = 0,8 \cdot 1,04 \cdot 102 = 84,91 \text{ kN} \\ P_{fi,Rd,2} = k_{c,\theta} P'_{Rd,2} = 0,954 \cdot 91 = 87,21 \text{ kN} \end{cases}$$

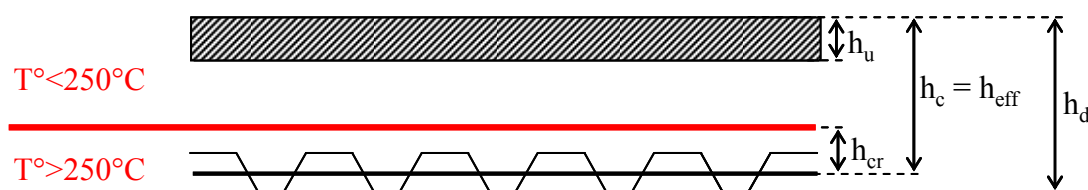


For the concerned beam, the limit of the tensile force is fulfilled:  $2334,096 \text{ kN} < 68 \cdot 84,91 = 5773,9 \text{ kN}$  (68 is the number of connectors on half of the beam)

Then, the thickness of the compressive zone  $h_u$  of the concrete slab is determined by considering the equilibrium of the forces in the section, and taking into account of the effective width of the slab  $b_{\text{eff}}$  calculated at ambient temperature (E.1(3)).

$$h_u = \frac{T}{b_{\text{eff}} f_c / \gamma_{M,fi,c}} = \frac{2334,096}{3000 \cdot 25 / 1,0} = 31,12 \text{ mm}$$

Before going further, it is necessary to verify, on the basis of Table D.5 (Annex D.3, EN 1994-1-2), that the temperature of the concrete in the compression zone is less than  $250^\circ\text{C}$ . If this is the case,  $h_u$  remains unchanged, otherwise it is necessary to recalculate  $h_u$  implementing an iterative procedure to take into account of the decrease of the concrete strength with the temperature.



**Fig.3.2.5** Verification of the temperature of the concrete in the compression zone

Moreover,  $h_u$  is less than  $h_1$ , then the equations also apply for the composite slabs with steel deck (E.1(6), EN 1994-1-2).

The effective thickness of the composite slab is determined by the following equation (Annex D.4, EN 1994-1-2):

$$h_{\text{eff}} = h_1 + 0,5h_2 \left( \frac{\ell_1 + \ell_2}{\ell_1 + \ell_3} \right) = 62 + 0,5 \cdot 58 \left( \frac{101 + 62}{101 + 106} \right) = 84,8 \text{ mm}$$

where  $h_1$ ,  $\ell_1$ ,  $\ell_2$  and  $\ell_3$  are the geometric characteristics of the steel deck.

Thereafter, it is assumed that  $h_c = h_{\text{eff}} = 84,8 \text{ mm}$  (E.1(6), EN 1994-1-2)

Then it must be checked that the concrete strength in the compression zone is not affected by the temperature ( $\theta < 250^\circ\text{C}$ ) (E.1(4), EN 1994-1-2) by determining the critical height  $h_{\text{cr}}$  according to Table 3.2.2. The critical height  $h_{\text{cr}}$  is the height which corresponds to a temperature of  $250^\circ\text{C}$ .

$$(h_c - h_u) = 8,48 - 3,112 = 5,371 \text{ cm} \geq h_{\text{cr}} = 5,0 \text{ cm} \Rightarrow \text{compression zone } T < 250^\circ\text{C}$$

Therefore,  $h_u$  remain unchanged and it is not needed to reduce the strength of the compression part.

The location of the compression force (with regard to the bottom flange) is given by the following equation (E.1(5), EN 1994-1-2):

$$y_F \approx h + h_c - (h_u / 2) = 45 + 8,48 - (3,112 / 2) = 51,928 \text{ cm}$$

And the moment resistance:

$$M_{fi,Rd} = T(y_F - y_T) = 2334,1 \cdot (0,51928 - 0,2226) = 692,4 \text{ kNm}$$

**Check:**

The moment resistance should be greater than the moment applied to the beam:

$$\frac{M_{fi,Ed}}{M_{fi,Rd}} = \frac{571,6}{692,4} = 0,83 < 1 \Rightarrow \text{the stability of the beam in the fire situation is fulfilled.}$$

**NOTE**

The Eqn.(E.6) from clause E.1.(5), EN 1994-1-2 is a simplified model for composite slabs with steel deck assuming that  $h_c = h_{eff}$ . A more accurate calculation considering the real height  $h_c$  of the composite slab leads to:

$$y_F \approx h + h_c - (h_u / 2) = 45 + 12 - (3,112 / 2) = 55,4 \text{ cm}$$

$$M_{fi,Rd} = T(y_F - y_T) = 2334,1(0,554 - 0,2226) = 774,5 \text{ kNm}$$

$$\frac{M_{fi,Ed}}{M_{fi,Rd}} = \frac{571,6}{774,5} = 0,74 < 1$$

**3.2.2.5 Critical temperature method (EN 1994-1-2)**

This method is only applicable to the symmetrical sections having a height less than 500mm and supporting a slab with a thickness exceeding 120mm.

Contrary to the previous method, the temperature distribution is assumed uniform in the steel profile and is based on the section factor of the bottom plate (§4.3.4.2.3, EN 1994-1-2).

For R60:

$$\eta_{fi,t} = f_{ay,\theta_{cr}} / f_{ay}$$

with

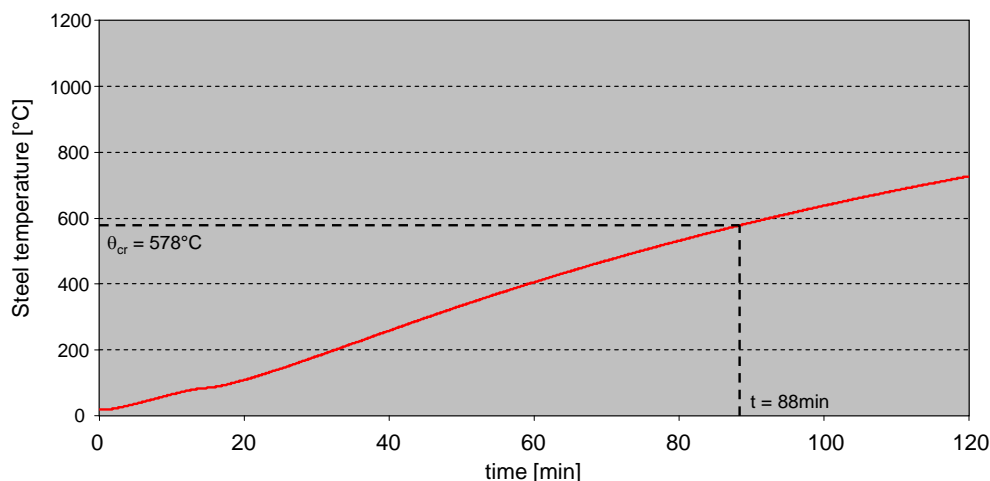
$$\eta_{fi,t} = \frac{M_{fi,Ed}}{M_{Rd}} = \frac{571,6}{1065} = 0,537 \quad (\text{see Annex 1 for the calculation of } M_{Rd})$$

$$\Rightarrow k_{y,\theta} = f_{ay,\theta_{cr}} / f_{ay} = 0,537$$

According to Table 3.2 of EN 1994-1-2 and a linear interpolation, the critical temperature of the steel is equal to 578°C. This critical temperature is reached after 88 minutes of ISO-fire exposure.

The critical temperature could be also calculated by the following equation (EN 1993-1-2, §4.2.4(2)):

$$\theta_{a,cr} = 39,19 \ln \left( \frac{1}{0,9674 \cdot \mu_0^{3,833}} - 1 \right) + 482 = 573,2^\circ\text{C} \quad \text{with } \mu_0 = 0,537 \text{ (EN 1993-1-2, Table 4.1)}$$



**Fig.3.2.6** Temperature evolution in function of the time. Bottom flange IPE450.

The height of the beam is less than 500mm, the temperature of the web is considered equal to the temperature of the bottom flange.

### 3.2.2.6 Verification of the vertical shear resistance (E.4, EN 1994-1-2)

#### Shear buckling verification (EN 1993-1-5, §5.1(2))

$$\frac{h_w}{t_w} = \frac{420,8}{9,4} = 44,77 \leq 72 \frac{\varepsilon}{\eta} = 72 \cdot \frac{0,81}{1,2} = 48,82$$

with  $\varepsilon = \sqrt{\frac{235}{355}} = 0,81$  and  $\eta = 1,2$  for steel grade up to S460.

#### Shear resistance verification (EN 1993-1-1, §6.2.6)

The shear resistance should satisfy

$$\frac{V_{fi,Ed}}{V_{pl,fi,Rd}} \leq 1,0$$

$$V_{pl,fi,Rd} = A_v \frac{f_{ay,\theta}}{\sqrt{3} \gamma_{M,fi,a}} = 5090 \cdot \frac{292,5}{\sqrt{3} \cdot 1,0} = 859,5 \text{ kN}$$

$$V_{fi,Ed} = \frac{p\ell}{2} = \frac{23,332 \cdot 14}{2} = 163,33 \text{ kN}$$

$$\frac{V_{fi,Ed}}{V_{pl,fi,Rd}} = \frac{163,33}{859,5} = 0,19 \leq 1,0 \quad \Rightarrow \text{OK}$$

### 3.3 Verification of the column

#### 3.3.1 Objective

This example checks the fire resistance of a composite column with a partially encased steel profile. The considered column is located on the ground floor of an office building (described in Chapter 2). The building frame is braced and the columns made of a composite cross-section with a steel profile HEA260 have a height of 3,40m, and are disposed such as to have the flanges of the steel profile parallel to the longest facade. The expected fire resistance is R60.

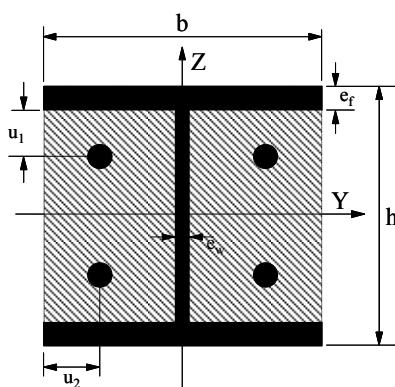


Fig.3.3.1 Cross-section of the column

#### Geometrical characteristics and material properties

##### Steel column

Steel profile:	HE 260 A
Steel grade:	S460
Height:	$h = 250 \text{ mm}$
Width:	$b = 260 \text{ mm}$
Web thickness:	$e_w = 7,5 \text{ mm}$
Flange thickness:	$e_f = 12,5 \text{ mm}$
Section area:	$A_a = 8680 \text{ mm}^2$
Yield strength:	$f_y = 355 \text{ N/mm}^2$
Young modulus:	$E_a = 210000 \text{ N/mm}^2$
Inertia:	$I_z = 3668 \text{ cm}^4$ (weak axis) $I_y = 10450 \text{ cm}^4$ (strong axis)

##### Reinforcing bars

Steel grade:	S500
Diameter:	$4\phi 28$
Area:	$A_s = 2463 \text{ mm}^2$
Yield strength:	$f_s = 500 \text{ N/mm}^2$

Young modulus:	$E_s = 210000 \text{ N/mm}^2$
Concrete cover:	$u_1 = 52 \text{ mm}$ $u_2 = 60 \text{ mm}$
Inertia:	$I_{s,z} = 4 \left[ \frac{\pi d^4}{64} + \frac{\pi d^2}{4} \left( \frac{b}{2} - u_2 \right)^2 \right] = 1324,6 \text{ cm}^4$ $I_{s,y} = 4 \left[ \frac{\pi d^4}{64} + \frac{\pi d^2}{4} \left( \frac{h}{2} - u_s \right)^2 \right] = 1218,9 \text{ cm}^4$

### Concrete

Class:	C30/37
Concrete cross section area:	$A_c = hb - A_a - A_s = 538,6 \text{ cm}^2$
Compressive strength:	$f_c = 30 \text{ N/mm}^2$

### Loads

#### Permanent loads:

Slab:	2,12 kN/m <sup>2</sup>
Finishing:	1,50 kN/m <sup>2</sup>
Facade:	2,0 kN/m

<u>Variable loads:</u>	4,0 kN/m <sup>2</sup>
------------------------	-----------------------

### 3.3.2 Mechanical actions in the fire situation (EN 1991-1-2)

The combination of the mechanical actions in fire situation should be calculated as accidental situation (§ 4.3, EN 1991-1-2).

$$E_d = E \left( \sum_{j \geq 1} G_{k,j} + (\psi_{1,1} \text{ or } \psi_{2,1}) Q_{k,1} + \sum_{i > 1} \psi_{2,i} Q_{k,i} \right)$$

The combination coefficient for main variable actions for this type of building is  $\psi_{2,1} = 0,6$ .

Therefore, the axial load applied to the column, weighted in fire situation is (see Annex 2):

- Design load per level from the central secondary beams:  $q = 23,351 \text{ kN/m}$
- Design load per level from the other secondary beams:  $q = 14,321 \text{ kN/m}$
- The axial load applied to the column for 1 level is:  $N_{fi,Rd} = 287,636 \text{ kN}$
- For the total height of the building (R+5):  $N_{fi,Rd} = 6 \cdot 287,636 = 1726 \text{ kN}$

### 3.3.3 Use of the tabulated data (EN 1994-1-2, §4.2.3.3, Table 4.6)

For a fire resistance of 60 minutes and  $0,28 < \eta_{fi,t} < 0,47$ , the tabulated data asks a minimum dimension  $h$  and  $b$  of 300mm. In case of HE260A,  $h=250\text{mm}$  and  $b=260\text{mm}$ .

Therefore, the tabulated data cannot be used.

### 3.3.4 Field of application of the simplified method (EN 1994-1-2, annex G)

The simplified calculation method consists to verify if the bearing capacity of the element is guaranteed after a given time  $t$  of fire exposure, i.e.:

$$N_{fi,d} / N_{fi,Rd} \leq 1$$

The Eurocode has developed only the calculation in case of a buckling according to the weak axis (Annex G, EN 1994-1-2). Axial compressive strength of a partially encased steel column, is calculated as follows (§4.3.5.1(2), EN 1994-1-2):

$$N_{fi,Rd,z} = \chi_z N_{fi,pl,Rd}$$

where:

$\chi_z$  is the reduction factor for the buckling curve  $c$ , which depends on the reduced slenderness  
 $N_{fi,pl,Rd}$  is the design value of the plastic resistance to axial compression in fire situation.

For a buckling according to the strong axis, the method is not explicitly given in the Eurocode 4. But it can be extended here for the strong axis.

The method given hereafter is restricted to columns in braced frames. First of all, one should check that the cross section of the column is in the limit of the field of application of the method. These limits are presented in Table 3.3.1 and compared to the geometric characteristics of the calculated column (§4.3.5.2, EN 1994-1-2).

**Table 3.3.1** Fields of application of the method

Conditions	Column	Fulfilled
$\ell_{\theta} \leq 13,5b = 13,5 \cdot 0,26 = 3,51\text{m}$	$\ell_{\theta y} = 0,7 \cdot 3,4 = 2,38\text{ m}$ $\ell_{\theta z} = 0,7 \cdot 3,4 = 2,38\text{ m}$ (explanations here below*)	YES
$230\text{mm} \leq h \leq 1100\text{mm}$	$h = 250\text{ mm}$	YES
$230\text{mm} \leq b \leq 500\text{mm}$	$b = 260\text{ mm}$	YES
$1\% \leq A_s / (A_c + A_s) \leq 6\%$	$24,63 / (538,6 + 24,63) = 4,4\%$	YES
max R120	R60	YES
$\ell_{\theta}$ limited to $10b$ if $230 \leq b < 300$	$\ell_{\theta z} = \ell_{\theta y} = 2,38 < 2,6\text{m}$	YES
* Concerning the buckling lengths, for a column submitted to the fire, they vary in function of the rotational stiffness of the support. The recommended values are 0,5 to 0,7 $\ell$ . Or, about the weak		

axis, it is considered that the buckling length in fire condition is the same as in cold condition as the column is fully heated (§4.3.5.1(10), EN 1994-1-2).

All the conditions are satisfied.

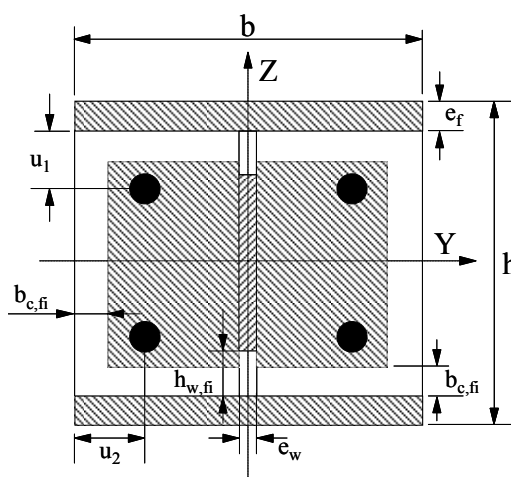
### 3.3.5 Calculation of the resistance to axial compression according to the weak axis

According to the method described in the Annex G of the EN 1994-1-2, the geometric and mechanical characteristics are conventionally reduced in accordance with the fire resistance to achieve.

The cross section of the column is divided into four parts:

- the flanges of the steel profile,
- the web of the steel profile,
- the concrete between the flanges,
- the reinforcing bars.

Each part can be evaluated on the basis of a reduced characteristic resistance, a reduced Young modulus and a reduced cross section.



**Fig.3.3.2** Reduced cross section for the fire resistance calculation

#### Contribution of the flanges of the steel profile

The mechanical characteristics (yield strength and Young modulus) of the flanges of the steel profiles must be reduced by reduction factors. For this, the average temperature of the flanges must be calculated (§G.2, EN 1994-1-2):

$$\theta_{f,t} = \theta_{0,t} + k_t A_m / V$$

Where  $t$  is the time of fire exposure in minutes,  $\theta_{0,t}$  is a temperature in °C and  $k_t$  is an empirical coefficient given in Table 3.3.2, and  $A_m/V$  is the section factor calculated according to the following relation:

$$\frac{A_m}{V} = \frac{2(h+b)}{hb} = 15,7 \text{ m}^{-1}$$





**Table 3.3.2** Parameters for the calculation of the average temperature of the flanges  
(EN 1994-1-2, Annex G, Table G.1)

Standard fire resistance	$\theta_{o,t}$ [°C]	$k_t$ [m°C]
R 30	550	9,65
R 60	680	9,55
R 90	805	6,15
R 120	900	4,65

For a fire resistance R60, the average temperature is:

$$\theta_{f,t} = 680 + 9,55 \cdot 15,7 = 830^\circ\text{C}$$

For that temperature, the reduction factors to apply to the mechanical characteristics of the flanges are determined from the Table 3.2 of the EN 1994-1-2.

Applying a linear interpolation for the intermediate values of the temperature,  $k_{y,\theta} = 0,095$  and  $k_{E,\theta} = 0,083$  are obtained.

The plastic resistance to axial compression and the effective bending stiffness of both flanges of the steel profile exposed to fire are determined by:

$$N_{fi,pl,Rd,f} = 2(b e_f f_{ay,f} k_{y,\theta}) / \gamma_{M,fi,a} = 2 \cdot (260 \cdot 12,5 \cdot 460 \cdot 0,095) / 1,0 = 284,3 \text{ kN}$$

$$(EI)_{fi,f,z} = E_{a,f} k_{E,\theta} (e_f b^3) / 6 = 210000 \cdot 0,083 \cdot (12,5 \cdot 260^3) / 6 = 640,4 \text{ kNm}^2$$

### Contribution of the web of the steel profile

A part of the web with a height  $h_{w,fi}$  starting at the lower face of the flange should be neglected. That part of the web is determined by (§G.3, EN 1994-1-2):

$$h_{w,fi} = 0,5(h - 2e_f) \left(1 - \sqrt{1 - 0,16(H_t / h)}\right),$$

where  $H_t$  is given by Table 3.3.3.

**Table 3.3.3** Reduction parameters for the web (EN 1994-1-2, Annex G, Table G.2)

Standard fire resistance	$H_t$ [mm]
R 30	350
R 60	770
R 90	1100
R 120	1250

For a fire resistance R60, is obtained:

$$h_{w,fi} = 0,5 \cdot (250 - 2 \cdot 12,5) \left(1 - \sqrt{1 - 0,16(770 / 250)}\right) = 32,4 \text{ mm}$$

The level of maximum stress in the remaining part of the web is obtained from:

$$f_{ay,w,t} = f_{ay,w} \sqrt{1 - (0,16H_t / h)} = 460 \sqrt{1 - (0,16 \cdot 770 / 250)} = 327,6 \text{ MPa}$$

The plastic resistance to axial compression and the effective bending stiffness of the web of the steel profile exposed to fire are determined by:

$$N_{fi,pl,Rd,w} = \left[ e_w (h - 2e_f - 2h_{w,fi}) f_{ay,w,t} \right] / \gamma_{M,fi,a} = (7,5(250 - 2 \cdot 12,5 - 2 \cdot 32,4) \cdot 327,6) / 1 = 393,7 \text{ kN}$$

$$(EI)_{fi,w,z} = \left[ E_{a,w} (h - 2e_f - 2h_{w,fi}) e_w^3 \right] / 12 = (210000(250 - 2 \times 12,5 - 2 \times 32,4) 7,5^3) / 12 = 1,18 \text{ kNm}^2$$

### Contribution of the concrete

A layer of concrete, of a thickness  $b_{c,fi}$  should be neglected in the calculation. This thickness is given in Table 3.3.4 as a function of the fire resistance.

For R60, is obtained (§G.4, EN 1994-1-2):

**Table 3.3.4** Reduction thickness of the concrete (EN 1994-1-2, Annex G, Table G.3)

Standard fire resistance	$b_{c,fi}$ [mm]
R30	4,0
R60	15,0
R90	$0,5(A_m/V) + 22,5$
R120	$2,0(A_m/V) + 24,0$

The compression resistance of the remaining concrete cross section must be reduced by the reduction factor  $k_{c,\theta}$  depending on the average temperature of the concrete. This average temperature of the concrete is given in Table 3.3.5 as a function of the section factor  $A_m/V$  of the composite cross section.

**Table 3.3.5** Average temperature of the concrete as a function of the section factor of the composite cross section (EN 1994-1-2, Annex G, Table G.4)

R30		R60		R90		R120	
$A_m/V$ [m <sup>-1</sup> ]	$\theta_{c,t}$ [°C]	$A_m/V$ [m <sup>-1</sup> ]	$\theta_{c,t}$ [°C]	$A_m/V$ [m <sup>-1</sup> ]	$\theta_{c,t}$ [°C]	$A_m/V$ [m <sup>-1</sup> ]	$\theta_{c,t}$ [°C]
4	136	4	214	4	256	4	265
23	300	9	300	6	300	5	300
46	400	21	400	13	400	9	400
---	---	50	600	33	600	23	600
---	---	---	---	54	800	38	800
---	---	---	---	---	---	41	900
---	---	---	---	---	---	43	1000

The average temperature in the concrete is obtained by interpolation. For a fire resistance R60 and a section factor equal to  $A_m/V = 15,7 \text{ m}^{-1}$ , is obtained  $\theta_{c,t} = 356^\circ\text{C}$ .

Based on this temperature, the reduction factor  $k_{c,\theta}$  and the deformation  $\varepsilon_{cu,\theta}$  are deduced from the Table 3.3 of the EN 1994-1-2, according to the compressive resistance  $f_{c,\theta}$ :  $k_{c,\theta} = 0,79$  and  $\varepsilon_{cu,\theta} = 8,68 \cdot 10^{-3}$ .

The secant modulus of the concrete is obtained by:

$$E_{c,\text{sec},\theta} = \frac{f_{c,\theta}}{\varepsilon_{cu,\theta}} = \frac{f_c \cdot k_{c,\theta}}{\varepsilon_{cu,\theta}} = \frac{30 \cdot 0,79}{8,68 \cdot 10^{-3}} = 2746,4 \text{ MPa}$$

The plastic resistance to axial compression and the effective bending stiffness of the concrete are determined by:

$$N_{fi,pl,Rd,c} = 0,86 \left\{ (h - 2e_f - 2b_{c,fi}) (b - e_w - 2b_{c,fi}) - A_s \right\} f_{c,\theta} / \gamma_{M,fi,c}$$

$$N_{fi,pl,Rd,c} = 0,86 \left\{ (250 - 2 \cdot 12,5 - 2 \cdot 15) (260 - 7,5 - 2 \cdot 15) - 2463 \right\} 25 \cdot 0,79 / 1 = 839 \text{ kN}$$

$$(EI)_{fi,c,z} = E_{c,\text{sec},\theta} \left[ \left\{ (h - 2e_f - 2b_{c,fi}) \left( (b - 2b_{c,fi})^3 - e_w^3 \right) / 12 \right\} - I_{s,z} \right]$$

$$(EI)_{fi,c,z} = 2746,4 \left[ \left\{ (250 - 2 \cdot 12,5 - 2 \cdot 15) \left( (260 - 2 \cdot 15)^3 - 7,5^3 \right) / 12 \right\} - 1324,6 \cdot 10^4 \right] = 509,5 \text{ kNm}^2$$

### Contribution of the reinforcing bars

The contribution of the reinforcing bars is taken into account by reducing their mechanical characteristics (yield strength and Young modulus). The reduction factor of the yield strength  $k_{y,t}$ , and the reduction factor of the Young modulus  $k_{E,t}$  of the reinforcing bars are determined according to Table 3.3.6 and Table 3.3.7 in function of the standard fire resistance, and of the mean value  $u$  of the axis distances between the reinforcing bars and the borders of concrete.

The mean value  $u$  is obtained by the following equation (§G.5, EN 1994-1-2):

$$u = \sqrt{u_1 u_2} = \sqrt{52 \cdot 60} = 55,86 \text{ mm}$$

$u_1$  is the axis distance from the external reinforcing bar to the inner side of the flange

$u_2$  is the axis distance from the external reinforcing bar to the concrete border.

**Table 3.3.6** Reduction factor  $k_{y,t}$  for the yield strength  $f_{sy}$  of the reinforcing bars

Standard fire resistance	u [mm]				
	40	45	50	55	60
R30	1	1	1	1	1
R60	0,789	0,883	0,9763	1	1
R90	0,314	0,434	0,572	0,696	0,822
R120	0,170	0,223	0,288	0,367	0,436

**Table 3.3.7** Reduction factor  $k_{E,t}$  for the Young modulus  $E_s$  of the reinforcing bars

Standard fire resistance	u [mm]				
	40	45	50	55	60
R30	0,830	0,865	0,88	0,914	0,935
R60	0,604	0,647	0,689	0,729	0,763
R90	0,193	0,283	0,406	0,522	0,619
R120	0,110	0,128	0,173	0,233	0,285

For R60 fire resistance  $k_{y,t} = 1,0$  and  $k_{E,t} = 0,735$ .

The plastic resistance to axial compression and the effective bending stiffness of the reinforcing bars are determined by:

$$N_{fi,pl,Rd,s} = A_s k_{y,t} f_{s,y} / \gamma_{M,fi,s} = 2463 \cdot 1,0 \cdot 500 / 1,0 = 1231,5 \text{ kN}$$

$$(EI)_{fi,s,z} = k_{E,t} E_s I_{s,z} = (0,735 \cdot 210000 \cdot 1218,9 \cdot 10^4) = 1881,4 \text{ kNm}^2$$

### Plastic resistance of the composite section

The plastic resistance to axial compression of the composite section is obtained by addition of the resistance capacity of the different parts:

$$N_{fi,pl,Rd} = N_{fi,pl,Rd,f} + N_{fi,pl,Rd,w} + N_{fi,pl,Rd,c} + N_{fi,pl,Rd,s} = 284,3 + 393,7 + 839 + 1231,5 = 2748 \text{ kN}$$

The effective bending stiffness of the composite section should be reduced by the reduction coefficients given by Table 3.3.8:

$$(EI)_{fi,eff,z} = \varphi_{f,\theta} (EI)_{fi,f,z} + \varphi_{w,\theta} (EI)_{fi,w,z} + \varphi_{c,\theta} (EI)_{fi,c,z} + \varphi_{s,\theta} (EI)_{fi,s,z}$$

$$(EI)_{fi,eff,z} = 0,9 \cdot 640,4 + 1,0 \cdot 1,18 + 0,8 \cdot 509,5 + 0,9 \cdot 1881,4 = 2678,4 \text{ kNm}^2$$

**Table 3.3.8** Reduction coefficients for the effective bending stiffness

Standard fire resistance	$\varphi_{f,\theta}$	$\varphi_{w,\theta}$	$\varphi_{c,\theta}$	$\varphi_{s,\theta}$
R30	1,0	1,0	0,8	1,0
R60	0,9	1,0	0,8	0,9
R90	0,8	1,0	0,8	0,8
R120	1,0	1,0	0,8	1,0

### Determination of the axial buckling load at elevated temperatures (§ G.6, EN 1994-1-2)

The Euler buckling load is given by the following equation:

$$N_{fi,cr,z} = \frac{\pi^2 (EI)_{fi,eff,z}}{\ell_{0z}^2} N_{fi,cr,z} = \frac{\pi^2 \cdot 2678,4}{2,38^2} = 4667 \text{ kN}$$

where  $\ell_0$  is the buckling length of the column in case of fire.

The non-dimensional slenderness ratio is obtained from:

$$\bar{\lambda}_\theta = \sqrt{\frac{N_{fi,pl,R}}{N_{fi,cr,z}}} = \sqrt{\frac{2748}{4667}} = 0,767$$

where  $N_{fi,pl,R}$  is the value of  $N_{fi,pl,Rd}$  when the factors  $\gamma_{M,fi}$  are taken as 1,0

Using the buckling curve c, the reduction coefficient  $\chi_z$  is equal to 0,683 (EN 1994-1-1, §6.7.3.5).

The axial buckling resistance is:

$$N_{fi,Rd,z} = \chi_z N_{fi,pl,Rd} = 0,683 \cdot 2748 = 1876 \text{ kN} > N_{fi,Rd} = 1726 \text{ kN}$$

### 3.3.6 Calculation of the resistance to axial compression according to the strong axis

The calculation method is similar as previously except of the inertia. In our case, the method could not be applied for the design because the buckling length in case of fire according to the strong axis does not fulfill the limitation imposed by Eurocode 4.

Nevertheless, it will be used it for a pre-design.

#### Contribution of the flanges of the steel profile (§G.2, EN 1994-1-2)

$$N_{fi,pl,Rd,f} = 284,3 \text{ kN}$$

$$(EI)_{fi,f,y} = E_{a,f} k_{E,\theta} \left[ 2 \left( \frac{be_f^3}{12} + be_f \left( \frac{h}{2} - \frac{e_f}{2} \right)^2 \right) \right]$$

$$(EI)_{fi,f,y} = 210000 \cdot 0,083 \cdot \left[ 2 \cdot \left( \frac{260 \cdot 12,5^3}{12} + 260 \cdot 12,5 \left( \frac{250}{2} - \frac{12,5}{2} \right)^2 \right) \right] = 1604,5 \text{ kNm}^2$$

#### Contribution of the web of the steel profile (§G.3, EN 1994-1-2)

$$N_{fi,pl,Rd,w} = 393,7 \text{ kN}$$

$$(EI)_{fi,w,y} = \left[ E_{a,w} \left( h - 2e_f - 2h_{w,fi} \right)^3 e_w \right] / 12 = \left[ 210000 \cdot (250 - 2 \cdot 12,5 - 2 \cdot 32,4)^3 \cdot 7,5 \right] / 12 = 540 \text{ kNm}^2$$

#### Contribution of the concrete (§G.4, EN 1994-1-2)

$$N_{fi,pl,Rd,c} = 839 \text{ kN}$$

$$(EI)_{fi,c,y} = E_{c,sec,\theta} \left[ \left\{ \left( \frac{h}{2} - b_{c,fi} - \frac{e_w}{2} \right) \left( (b - 2e_f - 2b_{c,fi})^3 \right) / 6 \right\} - I_{s,y} \right]$$

$$(EI)_{fi,c,y} = 2746,4 \left[ \left\{ \left( \frac{260}{2} - 15 - \frac{7,5}{2} \right) \left( (260 - 2 \cdot 12,5 - 2 \cdot 15)^3 \right) / 6 \right\} - 1218,9 \cdot 10^4 \right] = 341,2 \text{ kNm}^2$$

### Contribution of the reinforcing bars (§G.5, EN 1994-1-2)

$$N_{fi,pl,Rd,s} = 1231,5 \text{ kN}$$

$$(EI)_{fi,s,y} = k_{E,t} E_s I_{s,y} = 0,735 \cdot 210000 \cdot 1218,9 \cdot 10^4 = 2044,5 \text{ kNm}^2$$

### Plastic resistance of the composite section

The plastic resistance to axial compression of the composite section is obtained by addition of the resistance capacity of the different parts:

$$N_{fi,pl,Rd} = N_{fi,pl,Rd,f} + N_{fi,pl,Rd,w} + N_{fi,pl,Rd,c} + N_{fi,pl,Rd,s} = 284,3 + 393,7 + 839 + 1231,5 = 2748 \text{ kN}$$

The effective flexural stiffness of the composite section should be reduced by the reduction coefficients given in Table 3.3.8:

$$(EI)_{fi,eff,y} = \varphi_{f,\theta} (EI)_{fi,f,y} + \varphi_{w,\theta} (EI)_{fi,w,y} + \varphi_{c,\theta} (EI)_{fi,c,y} + \varphi_{s,\theta} (EI)_{fi,s,y}$$

$$(EI)_{fi,eff,y} = 0,9 \cdot 1604,5 + 1,0 \cdot 540 + 0,8 \cdot 341,2 + 0,9 \cdot 2044,5 = 4097,1 \text{ kNm}^2$$

### Determination of the axial buckling load at elevated temperatures (§ G.6, EN 1994-1-2)

The Euler buckling load is given by the following equation:

$$N_{fi,cr,y} = \frac{\pi^2 (EI)_{fi,eff,y}}{\ell_{\theta y}^2} = \frac{\pi^2 4097,1}{2,38^2} = 7138,8 \text{ kN}$$

where  $\ell_{\theta}$  is the buckling length of the column in case of fire.

The non-dimensional slenderness ratio is obtained from:

$$\bar{\lambda}_{\theta} = \sqrt{\frac{N_{fi,pl,R}}{N_{fi,cr,y}}} = \sqrt{\frac{2748}{7138,8}} = 0,62$$

where  $N_{fi,pl,R}$  is the value of  $N_{fi,pl,Rd}$  when the factors  $\gamma_{M,fi}$  are taken as 1,0.

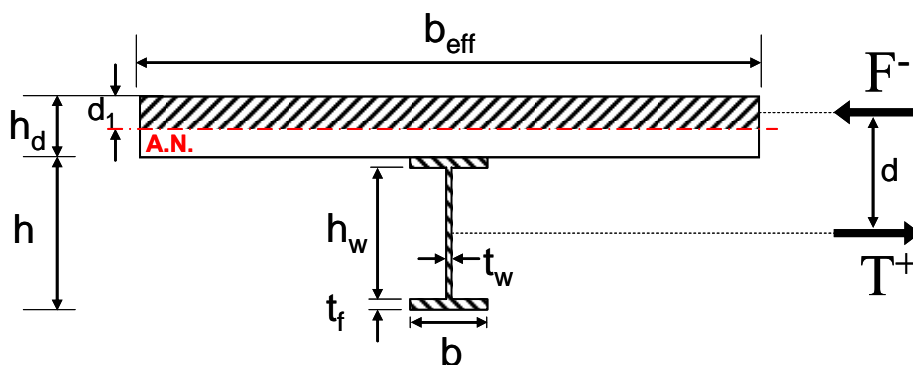
Using the buckling curve c, the reduction coefficient  $\chi_y$  is equal to 0,773 (EN 1994-1-1, §6.7.3.5)

The axial buckling resistance is:

$$N_{fi,Rd,y} = \chi_y N_{fi,pl,Rd} = 0,773 \cdot 2748 = 2124,8 \text{ kN} > N_{fi,Rd} = 1726 \text{ kN}$$

### 3.4 Annex 1

#### Calculation of $M_{Rd}$



$$M_{Rd} = Td$$

Position of the neutral axis:

$$\frac{Af_y}{\gamma_{M0}} = b_{eff} d_1 \frac{0,85 f_{ck}}{\gamma_{M1}} \quad \Rightarrow d_1 = 82,53 \text{ mm}$$

$$M_{Rd} = \frac{Af_y}{\gamma_{M0}} d = \frac{9880 \cdot 355}{1,0} \cdot 303,74 \cdot 10^{-6} = 1065 \text{ kNm}$$

#### Note

$M_{Rd}$  is calculated for full shear connection; might be slightly reduced in case of partial connection  
( $M_{Rd} = 1015 \text{ kNm}$  with 136 studs  $\phi 19$ )

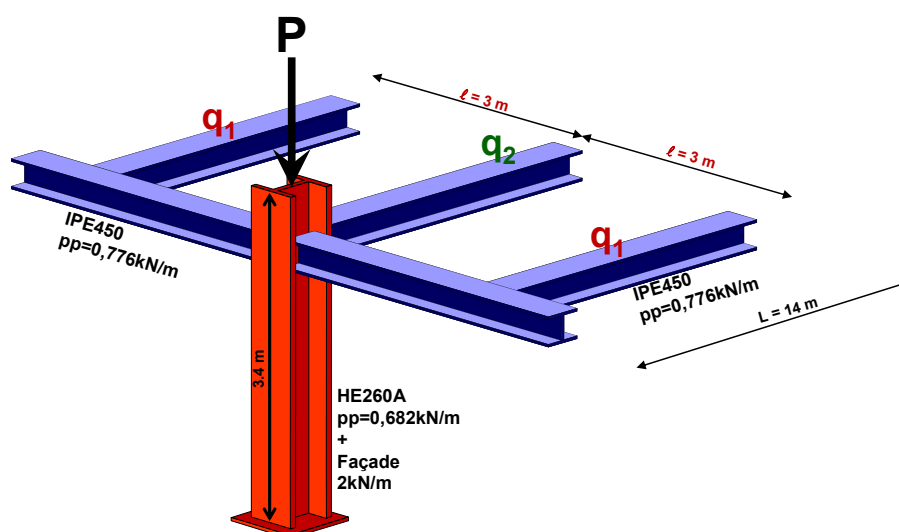
Fire software to calculate Composite Beams (ABC) and Columns (A3C) are available on the “Download Center” Tab of [www.arcelormittal.com/sections/](http://www.arcelormittal.com/sections/), or directly to:

- ⇒ <http://www.arcelormittal.com/sections/download-center/design-software/composite-solutions.html> (ABC)
- ⇒ <http://www.arcelormittal.com/sections/download-center/design-software/steel-solutions.html> (A3C)

### 3.5 Annex 2

#### Composite Column Loading

Permanent loads:	Slab = 2,12 kN/m <sup>2</sup> Finishing = 1,50 kN/m <sup>2</sup> Facade = 2,0 kN/m
Variable loads:	q <sub>k</sub> = 4,0 kN/m <sup>2</sup>



The combination of the mechanical actions in fire situation is

$$E_d = E \left( \sum_{j \geq 1} G_{k,j} + (\psi_{1,1} \text{ ou } \psi_{2,1}) Q_{k,1} + \sum_{i > 1} \psi_{2,i} Q_{k,i} \right) \quad \text{with } \psi_{2,1} = 0,6.$$

Design load per level from the central secondary beams

$$q_1 = 1,25 \cdot [(2,12 + 1,50 + 0,6 \cdot 4,0) \cdot 3] + 0,776 = 23,351 \text{ kN/m}$$

Design load per level from other secondary beams

$$q_2 = 0,750 \cdot [(2,12 + 1,50 + 0,6 \cdot 4,0) \cdot 3] + 0,776 = 14,321 \text{ kN/m}$$

$$P = 2 \cdot (23,351 \cdot 14 / 4) + (14,321 \cdot 14 / 2) + 2 \cdot 6 + 0,776 \cdot 6 + 2,14 \cdot 3,4 = 287,636 \text{ kN}$$

For the building

$$R + 5 \Rightarrow P = 6 \cdot 287,636 = 1726 \text{ kN}$$



## **CHAPTER 4**

### **FIRE RESISTANCE ASSESSMENT OF CONCRETE STRUCTURES ACCORDING TO EN 1992-1-2**

**Fabienne ROBERT**

CERIB, France

Other contributors for numerical modelling:

**L. Davenne<sup>1</sup>, L. Stoian<sup>2</sup>**

<sup>1</sup>NECS, France

<sup>2</sup>CERIB, France



## 4.1 Motivation

To any construction, the fire is a definite danger that needs to be prevented and fought by all possible means. The fire may occur anywhere and in any phase in the lifetime of a building (construction, service, refurbishment or demolition).

The aim of this chapter is to give a general overview of the fire design according to the Eurocodes (EN 1990, EN 1991-1-2 and EN 1992-1-2) through some examples drawn out of a concrete building which has been designed in a previous workshop dedicated to the concrete structure design (“Design of Concrete Buildings”, Workshop with worked examples, 20-21 October 2011, Brussels, organized by JRC). The fire load-bearing capacity of three concrete members (a column, a beam and a slab) will be in particular determined.

The EN 1990 concerns the basis of the structural design. The EN 1991-1-2 describes the thermal and mechanical actions for the structural design of building exposed to fire. The EN 1992-1-2 describes the principles, requirements and rules for the structural design of building for the accidental situation of fire exposure, including the safety requirements, design procedure and design aids.

In this chapter, the prescriptive approach is adopted (in opposite to the performance-based code), i.e. it uses nominal fires to generate thermal actions like the standard temperature-time curve (EN 1991-1-2, Section 3). Needless to say that EN 1991-1-2 and EN 1992-1-2 are intended to be used in conjunction with EN 1991-1-1 and EN 1992-1-1.

To make things clear, should be reminded that the fire resistance is the ability of a structure, a part of a structure or a member to fulfill its required functions (load bearing function and/or fire spreading function) for a specified load level, for a specified fire exposure and for a specified period of time.

In this paper, the different methods given in EN 1992-1-2, Section 4, will be illustrated that is to say:

- The use of tabulated data which gives detailing according to recognized solutions (EN 1992-1-2, Section 5);
- The use of simplified calculation methods to structural members (EN 1992-1-2, Section 4.2);
- The use of advanced calculation methods (EN 1992-1-2, Section 4.3)

EN 1992-1-2 gives alternative procedures, values and recommendations for classes with notes indicating where national choices may have to be made. Therefore the National Standard implementing EN 1992-1-2 should have a National Annex containing the Eurocode Nationally Determined Parameters (NDPs) to be used for the design of buildings, and where required and applicable, for civil engineering works to be constructed in the relevant country. However, for this design example, no National Annex has been selected, and the recommended values for the NDPs given in EN 1992-1-2 have been used.

## 4.2 Data concerning the studied building

### 4.2.1 Description of the building

The building consists of two levels for underground parking, a ground level floor and 5 floors for offices which are open to public. The plan view and the main sections of the building are given in Figures 4.2.1 to 4.2.4.

In this paper, the attention will be concentrated on:

- The T-beam in axis 2 which is a continuous beam. It has been calculated in Chapter 3 concerning Limit State Design (ULS-SLS) of the JRC Scientific&Policy report “Design of Concrete Buildings” with worked examples. The length  $L_{\text{beam}}$  of the continuous beam is equal to 7,125 m. The width  $b_w$  of the web is 0,25 m. The height of the table  $h_{\text{slab}}$  is 0,18 m. The total height of the beam  $h_{\text{beam}}$  is 0,40 m;
- The 4 m high column B2 is the one in the second basement. Its effective length  $l_{0,\text{column}}$  has been calculated in the previously mentioned chapter concerning ULS-SLS and is equal to 3,1 m. The slenderness  $\lambda_{\text{column}}$  of the column at normal temperatures is equal to 22,5. The cross-section is a square of 0,50 m. Its section  $A_{c,\text{column}}$  is equal to 0,25 m<sup>2</sup>;
- The slab on the beams (A1B2). It is a two-way slab of uniform thickness ( $h_{\text{slab}} = 0,18$  m). The width of the slab in x-direction  $l_x$  is equal to 6 m and the width of the slab in y-direction  $l_y$  is equal to 7,125 m.

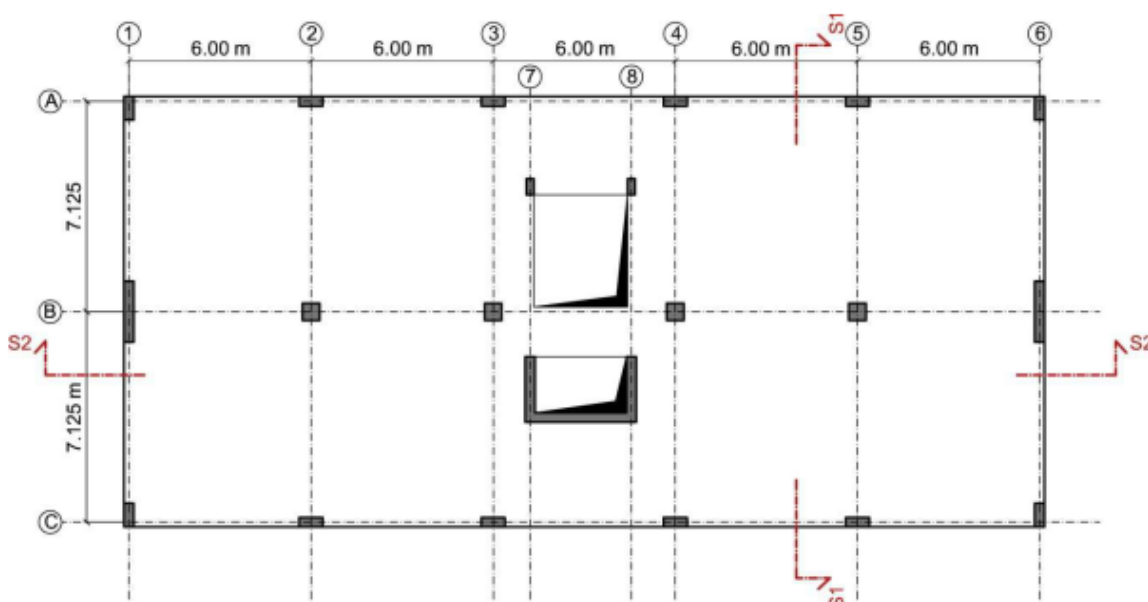
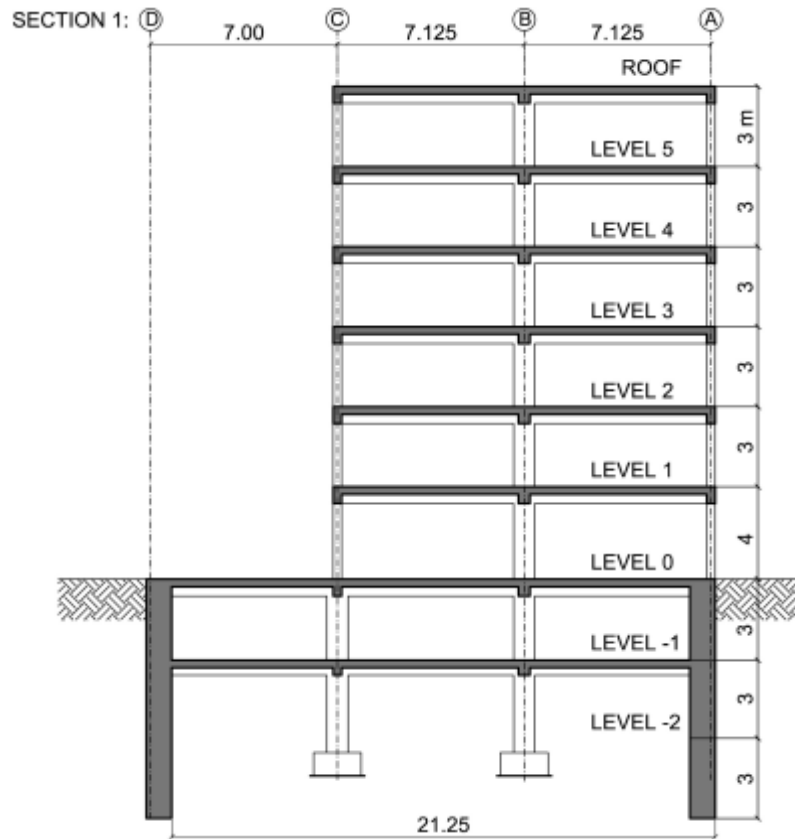
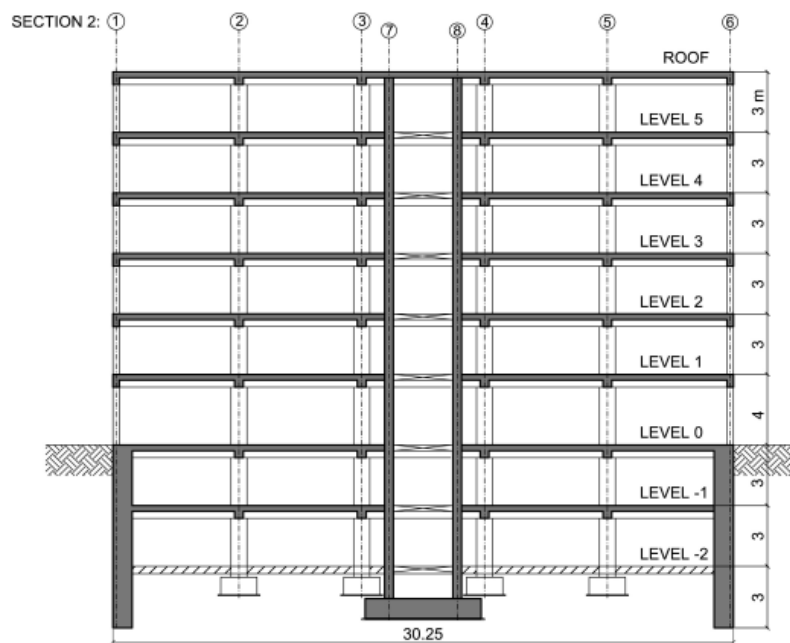


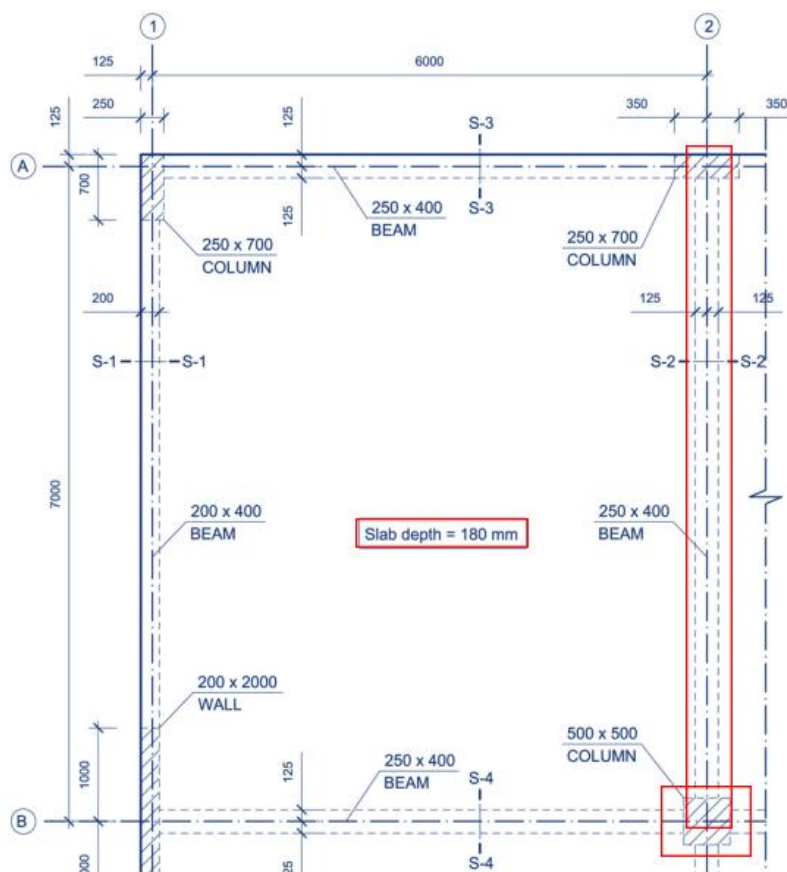
Fig.4.2.1 Ground view of the slab on beams



**Fig.4.2.2** Section 1 of the building



**Fig.4.2.3** Section 2 of the building



**Fig.4.2.4** View in plan of the elements to verify under fire (dimensions) – a column, a beam and a slab

## 4.2.2 Mechanical material properties

### 4.2.2.1 General

The values of the material properties shall be treated as characteristic values. These values may be used with simplified and advanced calculation methods. The mechanical properties of concrete and reinforcing steel at normal temperature are presented in EN 1992-1-1 for normal temperature design.

Moreover, design values of mechanical (strength and deformation) material properties  $X_{d,fi}$  are defined as follows (Eqn 4.1):

$$X_{d,fi} = k_{\theta} X_k / \gamma_{M,fi} \quad (4.1)$$

$X_k$  is the characteristic value of strength or deformation property for normal temperature design as described in EN 1992-1-1,  $k_{\theta}$  is the reduction factor for a strength or deformation property dependent on the material temperature ( $X_{k,\theta}/X_k$ ) and  $\gamma_{M,fi}$  is the partial safety factor for the relevant material property for the fire situation.

For thermal and mechanical properties of concrete and reinforcing steel,  $\gamma_{M,fi}$  is taken equal to 1.

Table 4.2.1 indicates, for each member, the class of concrete and reinforcement steel used.

**Table 4.2.1** Concrete class and steel class of members

Slab	Beam	Column
C25/30	C25/30	C30/37
Grade 500 class B	Grade 500 class B	Grade 500 class B

The exposure class considered is XC2-XC3. Anyway, due to non uniformity of EU national choices and to avoid country specific conditions, the nominal cover to reinforcement  $c_{nom}$  was fixed to 30 mm.

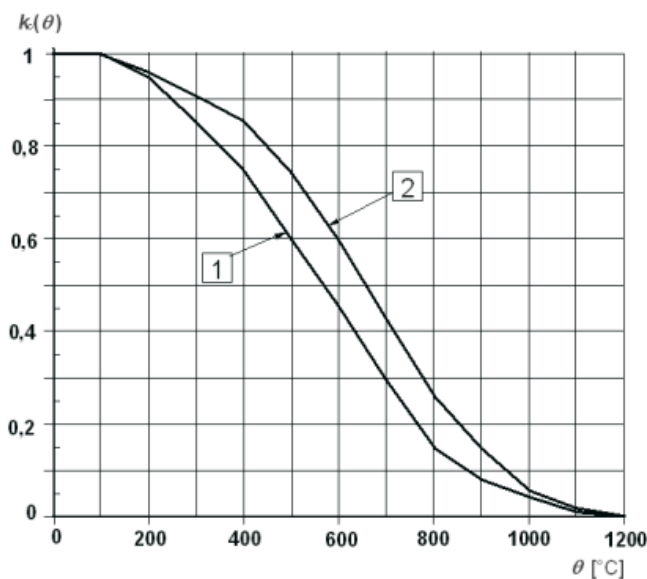
#### 4.2.2.2 Concrete

The concrete used in this building is assumed to be made of siliceous aggregates. The strength and deformation properties of uniaxially stressed concrete at elevated temperatures are presented in terms of stress-strain relationship, as described in EN 1992-1-2, Section 3. This relationship is described by two parameters: the compressive strength  $f_{c,\theta}$  and the strain  $\epsilon_{c1,\theta}$  corresponding to  $f_{c,\theta}$ . Values of each of these parameters are given in Table 4.2.2, as a function of concrete temperature.

The reduction factor for concrete strength dependent on the material temperature is presented in Figure 4.2.5.

**Table 4.2.2** Values for the main parameters of the stress-strain relationships of normal concrete with siliceous aggregates at elevated temperatures (from EN 1992-1-2, Section 3, Table 3.1)

Temperature (°C)	$f_{c,\theta}/f_{ck}$	$\epsilon_{c,\theta}$	$\epsilon_{c1,\theta}$
20	1,00	0,0025	0,0200
100	1,00	0,0040	0,0225
200	0,95	0,0055	0,0250
300	0,85	0,0070	0,0275
400	0,75	0,0100	0,0300
500	0,60	0,0150	0,0325
600	0,45	0,0250	0,0350
700	0,30	0,0250	0,0375
800	0,15	0,0250	0,0400
900	0,08	0,0250	0,0425
1000	0,04	0,0250	0,0450
1100	0,01	0,0250	0,0475
1200	0,00	-	-



**Fig.4.2.5** Coefficient  $k_c(\theta)$  allowing for decrease of characteristic strength  $f_{ck}$  of concrete (1: siliceous aggregates, 2: calcareous aggregates)

Mathematical model for stress-strain relationships of concrete under compression at elevated temperatures is as follows (Eqn 4.2) for  $\varepsilon < \varepsilon_{c1,\theta}$ :

$$\sigma(\theta) = \frac{3\varepsilon f_{c,\theta}}{\varepsilon_{c1,\theta} \left( 2 + \left( \frac{\varepsilon}{\varepsilon_{c1,\theta}} \right)^3 \right)} \quad (4.2)$$

For  $\varepsilon_{c1,\theta} < \varepsilon < \varepsilon_{cu1,\theta}$  and numerical purposes, a descending branch should be adopted.

#### 4.2.2.3 Reinforcing bars

The reinforcing steel used in this building is hot rolled steel. The strength and deformation properties of reinforcing steel at elevated temperatures is obtained from the stress-strain relationships, as described in EN 1992-1-2, Section 3. These stress-strain relationships are defined by three parameters: the slope of the linear elastic range  $E_{s,\theta}$ , the proportional limit  $f_{sp,\theta}$  and the maximum stress level  $f_{sy,\theta}$ . Values for those parameters are given in Table 4.2.4, as a function of steel temperature.

Mathematical model for stress-strain relationships of reinforcing steel at elevated temperatures is presented in Table 4.2.3.



**Table 4.2.3** Mathematical model for stress-strain relationships of reinforcing steel at elevated temperatures according to EN 1992-1-2, Section 3

Range	Stress $\sigma(\theta)$	Tangent modulus
$\varepsilon_{sp,\theta}$	$\varepsilon E_{s,\theta}$	$E_{s,\theta}$
$\varepsilon_{sp,\theta} \leq \varepsilon \leq \varepsilon_{sy,\theta}$	$f_{sp,\theta} - c + (b/a) \left[ a^2 - (\varepsilon_{sy,\theta} - \varepsilon)^2 \right]^{0,5}$	$\frac{b(\varepsilon_{sy,\theta} - \varepsilon)}{a \left[ a^2 - (\varepsilon - \varepsilon_{sy,\theta})^2 \right]^{0,5}}$
$\varepsilon_{sy,\theta} \leq \varepsilon \leq \varepsilon_{st,\theta}$	$f_{sy,\theta}$	0
$\varepsilon_{st,\theta} \leq \varepsilon \leq \varepsilon_{su,\theta}$	$f_{sy,\theta} \left[ 1 - (\varepsilon - \varepsilon_{st,\theta}) / (\varepsilon_{su,\theta} - \varepsilon_{st,\theta}) \right]$	-
$\varepsilon = \varepsilon_{su,\theta}$	0,00	-
Parameter *)	$\varepsilon_{sp,\theta} = f_{sp,\theta} / E_{s,\theta}$ $\varepsilon_{sy,\theta} = 0,02$ $\varepsilon_{st,\theta} = 0,15$ $\varepsilon_{su,\theta} = 0,20$ Class A reinforcement: $\varepsilon_{st,\theta} = 0,05$ $\varepsilon_{su,\theta} = 0,10$	
Functions	$a^2 = (\varepsilon_{sy,\theta} - \varepsilon_{sp,\theta}) (\varepsilon_{sy,\theta} - \varepsilon_{sp,\theta} + c/E_{s,\theta})$ $b^2 = c (\varepsilon_{sy,\theta} - \varepsilon_{sp,\theta}) E_{s,\theta} + c^2$ $c = \frac{(f_{sy,\theta} - f_{sp,\theta})^2}{(\varepsilon_{sy,\theta} - \varepsilon_{sp,\theta}) E_{s,\theta} - 2(f_{sy,\theta} - f_{sp,\theta})}$	

**Table 4.2.4** Values for the main parameters of the stress-strain relationships of hot rolled reinforcing steel at elevated temperatures (from EN 1992-1-2, Section 3, Table 3.2a)

Temperature (°C)	$f_{sy,\theta}/f_{yk}$	$E_{s,\theta}/E_s$
20	1,00	1,00
100	1,00	1,00
200	1,00	0,90
300	1,00	0,80
400	1,00	0,70
500	0,78	0,60
600	0,47	0,31
700	0,23	0,13
800	0,11	0,09
900	0,06	0,07
1000	0,04	0,04
1100	0,02	0,02
1200	0,00	0,00

### 4.2.3 Physical and thermal material properties

Thermal and physical material properties of concrete and steel are described in EN 1992-1-2, Section 3.

#### 4.2.3.1 Thermal elongation of concrete and steel

Variations of thermal elongation of concrete and steel with temperature are illustrated in Figure 4.2.6 and in Figure 4.2.7:

- Concrete - the thermal strain  $\varepsilon_c(\theta)$  of siliceous concrete may be determined from the following equations with reference to the length at 20°C ( $\theta$  is the concrete temperature), Eqn 4.3 and 4.4:

$$\varepsilon_c(\theta) = -1,8 \cdot 10^{-4} + 9 \cdot 10^{-6} \theta + 2,3 \cdot 10^{-11} \cdot \theta^3 \quad \text{for } 20^\circ\text{C} \leq \theta \leq 700^\circ\text{C} \quad (4.3)$$

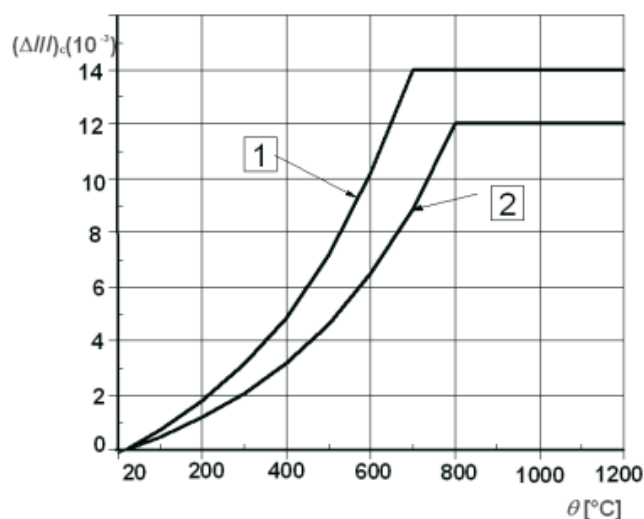
$$\varepsilon_c(\theta) = 14 \cdot 10^{-3} \quad \text{for } 700^\circ\text{C} < \theta \leq 1200^\circ\text{C} \quad (4.4)$$

- Steel - the thermal elongation of reinforcing steel  $\varepsilon_s(\theta)$  is described in EN 1992-1-2, Section 3 as follows (Eqn 4.5, 4.6 and 4.7):

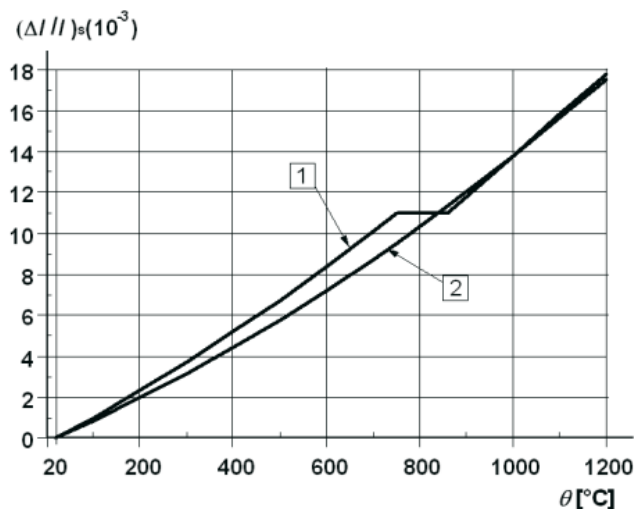
$$\varepsilon_{sc}(\theta) = -2,416 \cdot 10^{-4} + 1,2 \times 10^{-5} \cdot \theta + 0,4 \cdot 10^{-8} \cdot \theta^2 \quad \text{for } 20^\circ\text{C} \leq \theta \leq 750^\circ\text{C} \quad (4.5)$$

$$\varepsilon_c(\theta) = 11 \cdot 10^{-3} \quad \text{for } 750^\circ\text{C} < \theta \leq 860^\circ\text{C} \quad (4.6)$$

$$\varepsilon_{sc}(\theta) = -6,2 \cdot 10^{-3} + 2 \cdot 10^{-5} \cdot \theta \quad \text{for } 860^\circ\text{C} < \theta \leq 1200^\circ\text{C} \quad (4.7)$$



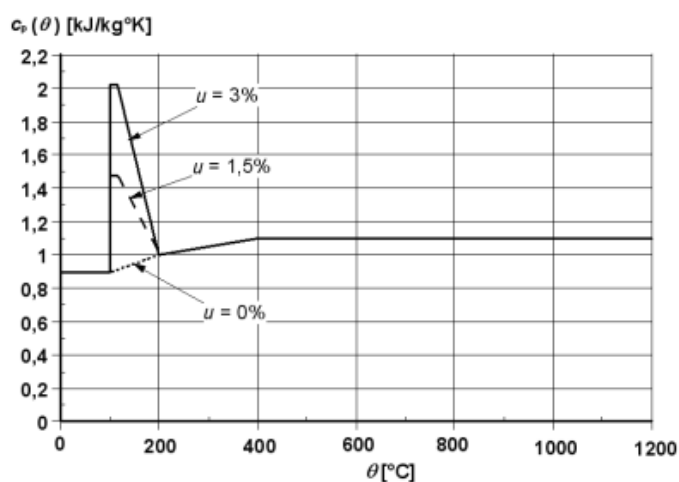
**Fig.4.2.6** Total thermal elongation (1: siliceous aggregates, 2: calcareous aggregates) according to EN 1992-1-2, Section 3.3.1



**Fig.4.2.7** Total thermal elongation of steel (1: reinforcing steel, 2: prestressing steel) according to EN 1992-1-2, Section 3.4

#### 4.2.3.2 Specific heat of concrete

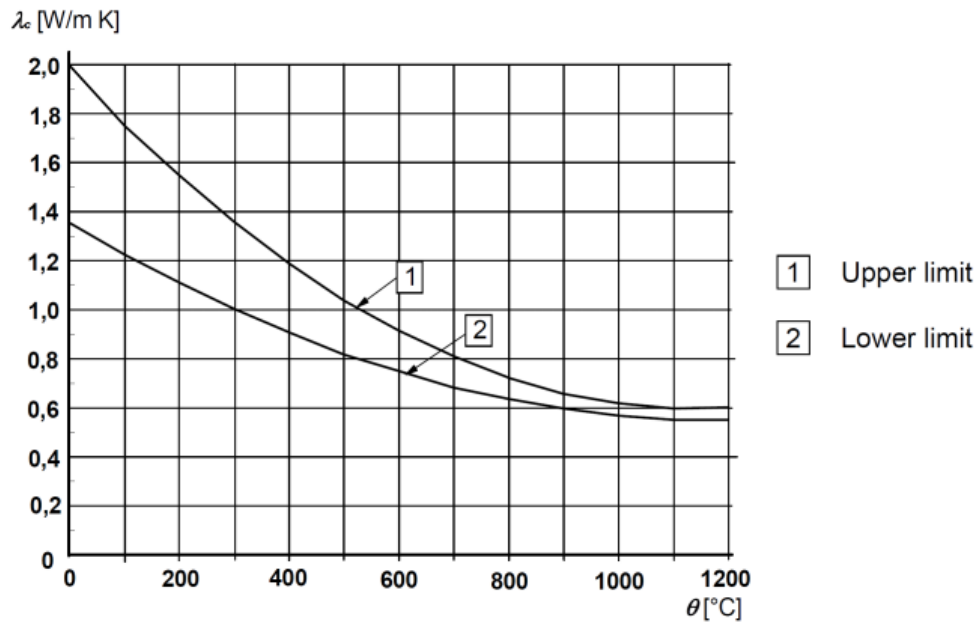
Calculation is made for a moisture content of 1,5% of concrete weight. The corresponding value of  $c_{p,peak}$  is equal to 1470 J/kg.K. Figure 4.2.8 illustrates the variation of the specific heat as a function of concrete temperature.



**Fig.4.2.8** Specific heat as function of temperature and moisture content by weight for siliceous concrete according to EN 1992-1-2, Section 3.3.2

#### 4.2.3.3 Thermal conductivity of concrete

For thermal conductivity  $\lambda_c$  of concrete, its value is set by the National Annex within the range defined by lower and upper limit. The lower limit has been used within EN 1992-1-2 to establish the temperature profiles given in EN 1992-1-2 Annex A. Thus it has been used for the present worked example (see Eqn 4.8 and Figure 4.2.9).



**Fig.4.2.9** Thermal conductivity of concrete according to EN 1992-1-2, Section 3.3.3

$$\lambda_c = 1,36 - 0,136 \cdot (\theta/100) + 0,0057 \cdot (\theta/100)^2 \text{ W/mK} \quad 20^\circ\text{C} \leq \theta \leq 1200^\circ\text{C} \quad (4.8)$$

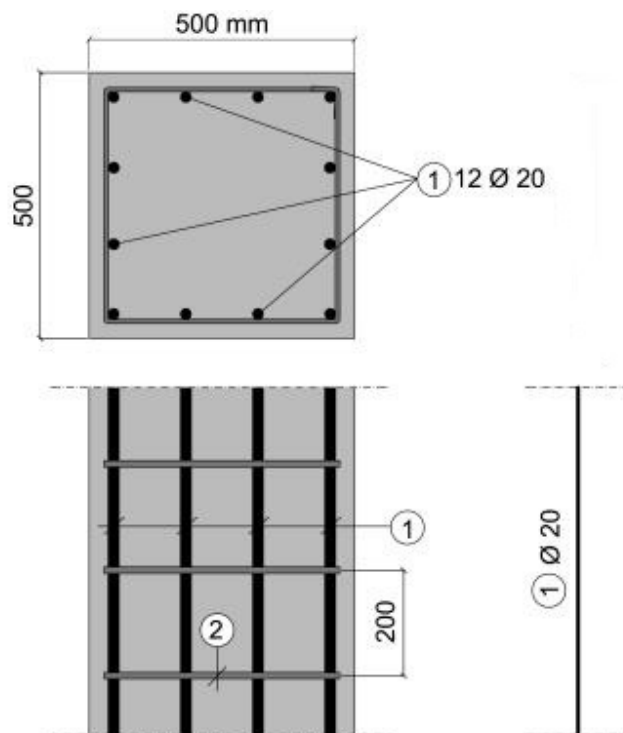
#### 4.2.3.4 Concrete density

The variation of density with temperature is influenced by water loss and is defined as described in EN 1992-1-2, Section 3.3.2.

### 4.2.4 Description of reinforcing bars in members (column, beam and slab)

#### 4.2.4.1 Column B2

According to the design performed in Chapter 3 of the JRC S&P report “Design of Concrete Buildings”, the calculation of the column reinforcement has led to apply 12 $\phi$ 20 (37,69 cm<sup>2</sup>) in a symmetric manner, with stirrups  $\phi$ 12/200 mm (see Figure 4.2.10 and Table 4.2.5).



**Fig.4.2.10** Layout of the reinforced column B2

**Table 4.2.5** Steel reinforcement of column B2

Longitudinal	Transversal
12 $\phi$ 20	$\phi$ 12/200 mm

The axis distance of the longitudinal steel bars is equal to  $a_{\text{column}}$ :  $30 \text{ mm} + 12 + 20/2 \text{ mm} = 52 \text{ mm}$ .

#### 4.2.4.2 Beam in axis 2

The beam in axis 2 is a continuous beam. The spans are equal to 7,125 m. The reinforcement steel is presented in Table 4.2.6.

**Table 4.2.6** Steel longitudinal (lower/upper) and transversal reinforcement of the beam in axis 2

Title 1	End support	Middle span	Intermediate support
Upper	7 $\phi$ 12	2 $\phi$ 10	9 $\phi$ 12
Lower	3 $\phi$ 16	3 $\phi$ 16	3 $\phi$ 16
Stirrups	$\phi$ 6/175	$\phi$ 6/175	$\phi$ 6/175

At the middle span, the axis distance  $a_{\text{mid-span,beam}}$  of the lower layer steel reinforcement from the exposed face is equal to 44 mm. At support, the axis distance  $a_{\text{support,beam}}$  of upper layer steel reinforcement from the non-exposed face is equal to 42 mm.

#### 4.2.4.3 Slab on beams

For this study, the solution “slabs on beams” is considered (see the chapter concerning ULS-SLS from the workshop “Design of Concrete Buildings” (20-21 October 2011)). The thickness  $h_{\text{slab}}$  is 0,18 m.

The reinforcement of the slab is shown in Figure 4.2.11 and Figure 4.2.12 and summarized in Table 4.2.7 and Table 4.2.8.

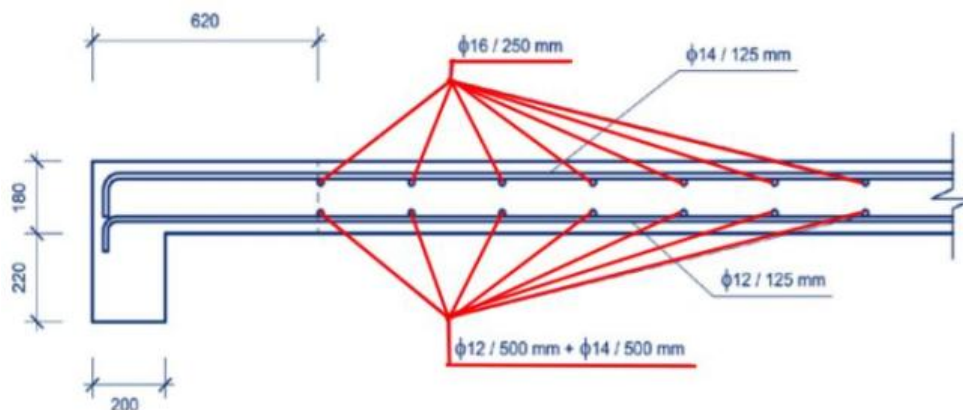


Fig.4.2.11 Layout of the reinforced slab

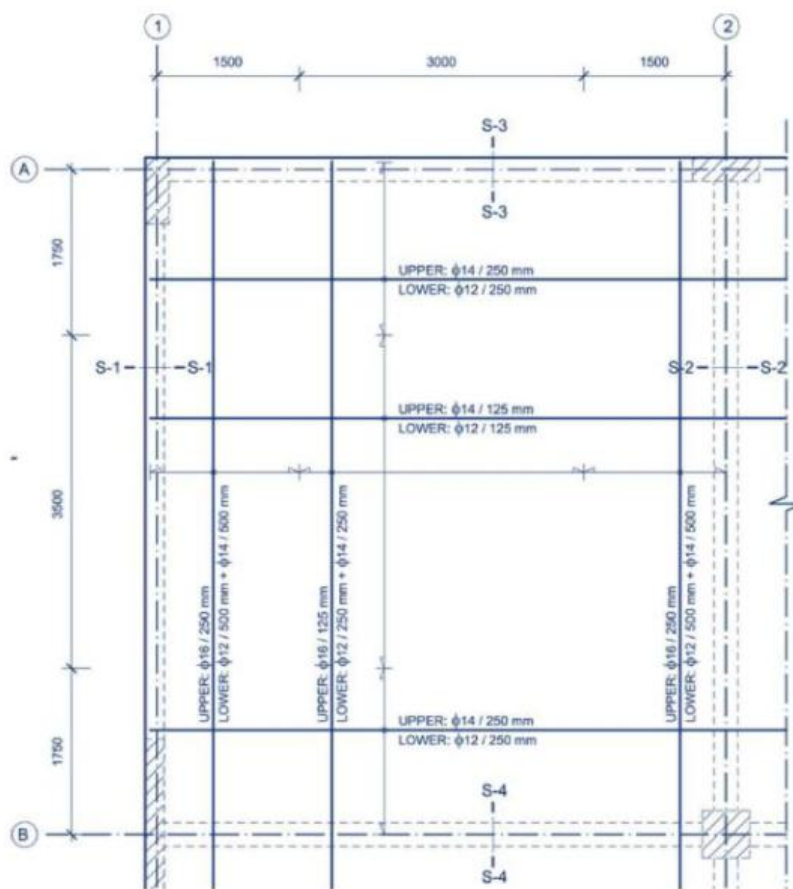


Fig.4.2.12 Layout of the reinforced slab

**Table 4.2.7** Longitudinal reinforcement of the slab in x-direction

<b>Middle strip (3,5 m)</b>	
Upper	$\phi 14/125$ mm
Lower	$\phi 12/125$ mm

**Table 4.2.8** Longitudinal reinforcement of the slab in y-direction

<b>Middle strip (3 m)</b>	
Upper	$\phi 16/125$ mm
Lower	$\phi 12/250$ mm $\phi 14/250$ mm

The axis distance of the lower layer  $a_{x,slab}$  of reinforcing steel in x-direction from the exposed surface is equal to:

$$a_{x,slab} = c_{nom} + \frac{\phi_x}{2} = 30 + \frac{12}{2} = 36 \text{ mm} \quad (4.9)$$

The axis distance of the lower layer  $a_{y,slab}$  of reinforcing steel in y-direction from the exposed surface is equal to:

$$a_{y,slab} = c_{nom} + \phi_x + \frac{\phi_y}{2} = 30 + 12 + \frac{14}{2} = 49 \text{ mm} \quad (4.10)$$

#### 4.2.5 Actions

The thermal and mechanical actions shall be taken from EN 1991-1-2. The emissivity related to the concrete surface should be taken as 0,7 (EN 1992-1-2, Section 2).

We will consider:

- The dead weight  $G_{slab}$  based on reinforced concrete unit weight of  $25 \text{ kN/m}^3$  and on the geometry of the slab;
- The imposed actions  $G_{imp}$  are finishing, pavement, embedded services and partitions;
- The variable actions  $Q_1$ .

For obtaining the relevant effects of actions  $E_{fi,d,t}$  during fire exposure, the mechanical actions shall be combined in accordance with EN 1990 for accidental design situations. The representative value of the variable action  $Q_1$  may be considered as the quasi-permanent value  $\psi_{2,1} Q_1$  (recommended value).  $\Psi_{2,1}$  is equal to 0,6 for Category C, offices open to public/meeting rooms (EN 1990, Annex A, Table A1.1).

**Table 4.2.9** Exterior actions acting on the slabs

$G_{\text{slab}}$	$G_{\text{Imp}}$	$Q_1$	$P_{\text{slab,fi}}$
4,5 kN/m <sup>2</sup>	1,5 kN/m <sup>2</sup>	4 kN/m <sup>2</sup>	8,4 kN/m <sup>2</sup>

The reduction factor  $\eta_{fi}$  for load combination is equal to:

$$n_{fi} = \frac{G_k + \psi_{fi} Q_{k,1}}{\gamma_G G_k + \gamma_{Q,1} Q_{k,1}} \quad (4.11)$$

$$n_{fi} = 0,6$$

The ratio  $l_x/l_y$  is equal to 0,84. The bending design isostatic moment in x-direction  $M_{0Ed,fi,x\text{-slab}}$  is given by  $\mu_x p_{\text{slab,fi}} l_x^2$  ( $\mu_x$  equals to 0,052). The design isostatic moment in y-direction  $M_{0Ed,fi,y\text{-slab}}$  is equal to  $\mu_y M_{0Ed,fi,x\text{-slab}}$  ( $\mu_y$  equals to 0,671).

**Table 4.2.10** Values of  $\mu_x$  and  $\mu_y$  as a function of the ratio  $l_x/l_y$  ( $v = 0$ )

$l_x/l_y$	$\mu_x = \frac{M_x}{pl_x^2}$	$\mu_y = M_y/M_x$
0,385	0,110	0,200(**)
0,40	0,109	0,204
0,45	0,102	0,220
0,50	0,095	0,241
0,55	0,088	0,282
0,60	0,081	0,327
0,65	0,0745	0,369
0,70	0,068	0,436
0,75	0,062	0,509
0,80	0,056	0,595
0,85	0,051	0,685
0,90	0,046	0,778
0,95	0,041	0,887
1,00	0,037	1,000

For the beam in axis 2, the design load is calculated from the maximum design moments  $M_{Ed}$  given in Chapter 3 of the JRC S&P report "Design of Concrete Buildings". It's obtained  $p_{\text{beamAB}} = 21$  kN/m, and multiplied by the reduction factor as a simplification,  $p_{\text{beamAB,fi}} = 12,6$  kN/m.

With regard to the shear capacity of the beam, the shear force may be determined at distance  $d$  from the support. At ambient temperature,  $V_{Ed,beam}$  is equal to 115,5 kN and multiplied by the reduction factor as a simplification,  $V_{Ed,fi\text{ beam}}$  is equal to 69,3 kN.

For column, the normal force  $N_{Ed,fi}$  under fire is equal to 2630 kN (the design normal force  $N_{Ed}$  is equal to 4384 kN). Actions on the column have been provided as data.

All actions acting on the slab, the beam and the column are summed up in Table 4.2.11.



**Table 4.2.11** Exterior actions acting on the slab, the beam (axis 2) and on the column B2

$M_{0Ed,fi,x-slab}$	$M_{0Ed,fi,y-slab}$	$M_{0Ed,fi,beam}$	$V_{Ed,fi,beam}$	$N_{Ed,fi,column}$
15,7 kNm/m	10,5 kNm/m	80,0 kNm	69,3 kN	2 630 kN

## 4.3 Tabulated data

### 4.3.1 Scope

The Eurocode fire parts give design solutions in terms of tabulated data (based on tests or advanced calculation methods), which may be used within the specified limits of validity.

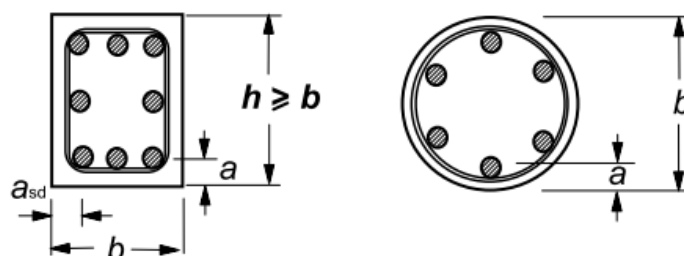
When using tabulated data, the considered member is considered as isolated. Indirect fire actions are not considered, except those resulting from thermal gradients.

Tabulated data give recognized design solutions for the standard fire exposure up to 240 minutes. The values, given in tables in terms of minimal cross-sectional dimensions and of minimum nominal axis distance, apply to normal weight concrete made with siliceous aggregates (Figure 4.3.1).

When using tabulated data, it is written in EN 1992-1-2, Section 5 that no further checks are required concerning shear and torsion capacity and spalling.

Tabulated data are based on a reference load level  $\eta_{fi}$  equal to 0,7.

Linear interpolation between the values given in the tables may be carried out.



**Fig.4.3.1** Sections through structural members showing nominal axis distance  $a$  and minimum dimensions (EN 1992-1-2, Section 5)

### 4.3.2 Column 500/52

Tabulated data are given for braced structures. For assessing the fire resistance of columns, two methods (A and B) are provided in EN 1992-1-2, Section 5. However, method A is applicable for columns whose effective length is less than 3 m. In this worked example, the effective length equals to 3,1 m. Thus method B is used which is applicable for  $\lambda_{fi} \leq 30$  ( $= 22,5$  in our case) and  $e_{max} = 100$  mm (30 mm in our case).

- Load level,  $n_{column}$ , at normal temperature conditions is given by:

$$n_{column} = \frac{N_{0Ed,fi}}{0,7(A_c f_{cd} + A_s f_{yd})} \quad (4.12)$$

- Slenderness of the column under fire conditions  $\lambda_{fi}$  as mentioned in EN 1992-1-2, Section 5.3.3, Note 2, is assumed to be equal to  $\lambda$  at normal temperature in all cases.
- The mechanical reinforcement ratio at normal temperature conditions is equal to:

$$w = \frac{A_s f_{yd}}{A_c f_{cd}} \quad (4.13)$$

All of these parameters are summed up in Table 4.3.1.

**Table 4.3.1** Parameters for method B (Tabulated data) – column B2

n	e	$\lambda_{fi}$	w
0,57	0,03	22,5	0,33

According to Table 4.3.2, and thanks to linear interpolation between the different column tables, it leads to classify the column R 90, as the minimum dimensions required for  $\omega=0,33$  and  $n=0,57$  are 500/43.

**Table 4.3.2** Minimum column dimensions and axis distances for reinforced concrete columns with a rectangular or circular section (EN 1992-1-2, Section 5)

Standard fire resistance	Mechanical reinforcement ratio $\omega$	Minimum dimensions (mm). Column width $b_{min}$ /axis distance a			
		$n = 0,15$	$n = 0,3$	$n = 0,5$	$n = 0,7$
1	2	3	4	5	6
R 30	0,100	150/25*	150/25*	200/30:250/25*	300/30:350/25*
	0,500	150/25*	150/25*	150/25*	200/30:250/25*
	1,000	150/25*	150/25*	150/25*	200/30:300/25*
R 60	0,100	150/30:200/25*	200/40:300/25*	300/40:500/25*	500/25*
	0,500	150/25*	150/35:200/25*	250/35:350/25*	350/40:550/25*
	1,000	150/25*	150/30:200/25*	200/40:400/25*	300/50:600/30
R 90	0,100	200/40:250/25*	300/40:400/25*	500/50:550/25*	550/40:600/25*
	0,500	150/35:200/25*	200/45:300/25*	300/45:550/25*	500/50:600/40
	1,000	200/25*	200/40:300/25*	250/40:550/25*	500/50:600/45
R 120	0,100	250/50:350/25*	400/50:550/25*	550/25*	550/60:600/45
	0,500	200/45:300/25*	300/45:550/25*	450/50:600/25*	500/60:600/50
	1,000	200/40:250/25*	250/50:400/25*	450/45:600/30	600/60
R 180	0,100	400/50:500/25*	500/60:550/25*	550/60:600/30	(1)
	0,500	300/45:450/25*	450/50:600/25*	500/60:600/50	600/75
	1,000	300/35:400/25*	450/50:550/25*	500/60:600/45	(1)
R 240	0,100	500/60:550/25*	550/40:600/25*	600/75	(1)
	0,500	450/45:500/25*	550/55:600/25*	600/70	(1)
	1,000	400/45:500/25*	500/40:600/30	600/60	(1)

\* Normally the cover required by EN 1992-1-1 will control.

(1) Requires width greater than 600 mm. Particular assessment for buckling is required.

### 4.3.3 Beam 250/44

The tabulated data in En 1992-1-2, Section 5 apply to beams which can be exposed to the fire on three sides. In this building, the upper side is insulated by slabs during the whole fire resistance period.

The beam has a constant width  $b_{w,beam}$  (equal to 0,25 m).

Table 4.3.3 provides minimum values of axis distance to the soffit and sides of continuous beams together with minimum values of width of the beam, for standard fire resistance of R30 to R240.

The beam has only one layer of reinforcement. Interpolation between columns 2 and 3 gives a width of 250 mm and an axis distance of 40 mm. However, it is indicated under the table, that for values of width inferior to values in column 3, an increase of  $a_{sd}$  is required. Then, for R120,  $a_{sd}$  should be equal to 50 mm (40 mm + 10 mm) which is higher than the value of 44 mm.

Note: it is assumed that the redistribution of bending moment for normal temperature design does not exceed 15 %. Otherwise, the continuous beam must be considered as a simply supported beam.

**Table 4.3.3** Minimum dimensions and axis distances for continuous beam made with reinforced concrete (EN 1992-1-2, Section 5)

Standard fire resistance	Minimum dimensions (mm)						
	Possible combinations of $a$ and $b_{min}$ where $a$ is the average axis distance and $b_{min}$ is the width of beam				Web thickness $b_w$		
					Class WA	Class WB	Class WC
1	2	3	4	5	6	7	8
R 30	$b_{min}= 80$ $a = 15^*$	160 12*			80	80	80
R 60	$b_{min}= 120$ $a = 25$	200 12*			100	80	100
R 90	$b_{min}= 150$ $a = 35$	250 25			110	100	100
R 120	$b_{min}= 200$ $a = 45$	300 35	450 35	500 30	130	120	120
R 180	$b_{min}= 240$ $a = 60$	400 50	550 50	600 40	150	150	140
R 240	$b_{min}= 280$ $a = 75$	500 60	650 60	700 50	170	170	160
$a_{sd} = a + 10\text{mm}$ (see note below)							
For prestressed beams the increase of axis distance according to 5.2(5) should be noted.							
$a_{sd}$ is the axis distance to the side of beam for the corner bars (or tendon or wire) of beams with only one layer of reinforcement. For values of $b_{min}$ greater than that given in Column 3 no increase of $a_{sd}$ is required.							
* Normally the cover required by EN 1992-1-1 will control.							

#### 4.3.4 Slab 180/36/49

Fire resistance of reinforced concrete slabs may be considered adequate if the values of Table 4.3.4 are applied. The minimum slab thickness  $h_s$  ensures adequate separating function (criterion E and I).

In this building, slabs are continuous solid slabs. This two-way slab is supported at all its four edges. The values given in Table 4.3.4 (column 2 and 4) apply to one-way or two-way continuous slab.

The ratio of the length in y-direction to the length in x-direction  $l_y/l_x$  is equal to  $1,19 < 1,5$ . Columns 2 and 4 of Table 4.3.4 apply.

Note: it is assumed that the moment redistribution does not exceed 15 % for ambient temperature design.

**Table 4.3.4** Minimum dimensions and axis distance for reinforced concrete simply supported one-way and two-way solid slabs (EN 1992-1-2, Section 5)

Standard fire resistance	Minimum dimensions (mm)			
	slab thickness $h_s$ (mm)	axis-distance $a$		
		one way	two way:	
			$l_y/l_x \leq 1,5$	$1,5 < l_y/l_x \leq 2$
1	2	3	4	5
REI 30	60	10*	10*	10*
REI 60	80	20	10*	15*
REI 90	100	30	15*	20
REI 120	120	40	20	25
REI 180	150	55	30	40
REI 240	175	65	40	50

$l_x$  and  $l_y$  are the spans of a two-way slab (two directions at right angles) where  $l_y$  is the longer span.

For prestressed slabs the increase of axis distance according to 5.2(5) should be noted.

The axis distance  $a$  in Column 4 and 5 for two way slabs relate to slabs supported at all four edges. Otherwise, they should be treated as one-way spanning slab.

\* Normally the cover required by EN 1992-1-1 will control.

The axis distance in X-direction is less than 40 mm which leads to classify the slab R180. However, additional rules on rotation capacity on supports may be given in the National Annex.

As an example, hereafter are given the additional rules on rotation capacity on supports in the French National Annex. In case of a continuous slab, if the condition of the slab thickness is verified (see Eqn.3.4), the calculation under fire may be avoided provided the axis distance of column 5 of Table 4.3.4 is used.

The French National Annex indicates too, that on the supports, under ambient temperature, a reinforcement balancing at least 50 % of the isostatic bending moment must be put, disposed over a length representing at least a third of the longest contiguous span.

The condition of the thickness of the slab is:

$$h > -h_0 + \frac{b_0}{\frac{100\Omega_R}{L} - a_0} \quad (4.14)$$

Limiting values for the angle  $\Omega$  of the yield hinge ( $\Omega_R$ ) are based on properties of reinforcement:

- $\Omega_R = 0,10$  for class A
- $\Omega_R = 0,25$  for class B or C
- $\Omega_R = 0,08$  for wire mesh

L is half the sum of the two fictitious spans located west and east of the support. In y-direction, L equals to 7,125 m and in X-direction, L equals to 5,40 m.

Coefficients  $a_0$ ,  $b_0$  and  $h_0$  are presented in Table 4.3.5.

**Table 4.3.5** Coefficients  $a_0$ ,  $b_0$  and  $h_0$

REI	$a_0$	$b_0$	$h_0$
30	-1,81	0,882	0,0564
60	-2,67	1,289	0,0715
90	-3,64	1,868	0,1082
120	-5,28	3,097	0,1860
180	-40,20	105,740	2,2240

The numerical application leads to the following height according to different duration of fire, see Table 4.3.6 ( $\Omega_R = 0,25$ ).

**Table 4.3.6** Minimum height h of the slab ( $\Omega_R = 0,25$ )

$\Omega_R = 0,25$	L=7,125 m (in Y-direction)	L=5,40 m (in X-direction)
30 min	0,109 m	0,081 m
60 min	0,137 m	0,105 m
90 min	0,153 m	0,118 m
120 min	0,166 m	0,127 m
180 min	0,195 m	0,135 m

Table 4.3.6 shows that for 180 minutes, the condition is not verified ( $0,195 \text{ m} > h_{\text{slab}}$ ).

The slab can assure its load-bearing capacity up to 120 minutes.

#### 4.3.5 Conclusion

All conclusions obtained with tabulated data are summed up in Table 4.3.7.

**Table 4.3.7** Duration of load bearing capacity of members with tabulated data

	Column	Beam	Slab
Tabulated data	R90	R90	R120

## 4.4 Simplified calculation methods

### 4.4.1 Methodology

In this part, the member is considered as isolated. Indirect fire actions are not considered, except those resulting from thermal gradients.

Simplified calculation methods are used to determine the ultimate load-bearing capacity of a heated cross-section and to compare the capacity with the relevant combination of actions. It shall indeed be verified that the design effect of actions for the fire situation  $E_{d,fi}$  is less than or equals to the corresponding design resistance in the fire situation  $R_{d,t,fi}$ .

For this worked example, temperatures profiles in concrete cross-sections subjected to a fire standard exposure are determined from numerical calculation (thermal analysis led on ANSYS) by using thermal properties of concrete (see section 2.3).

In EN 1992-1-2, Section 4 and in EN 1992-1-2, Annex B, three main simplified methods are described:

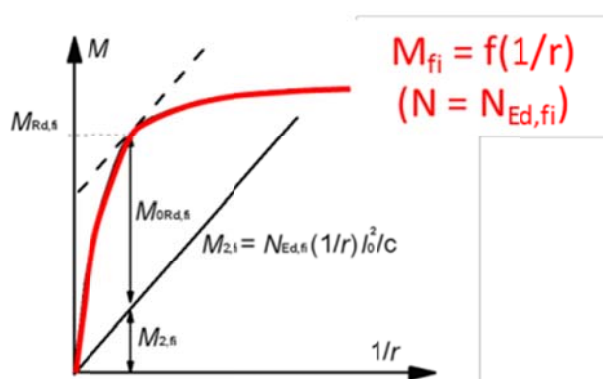
- Method ‘500°C isotherm method’: this method is applicable to a standard fire exposure and any other time heat regimes, which cause similar temperature fields in the fire exposed member. This method is valid for minimum width of cross-section depending on the fire resistance or on the fire load density (see EN 1992-1-2, Annex B, Table B1). The thickness of the damaged concrete  $a_{500}$  is made equal to the average depth of the 500°C isotherm in the compression zone of the cross-section. Concrete with temperatures in excess of 500°C is assumed not to contribute to the load bearing capacity of the member, whilst the residual concrete cross-section retains its initial values of strength and modulus of elasticity.
- Method ‘Zone method’: this method provides more accurate results than the previous one especially for columns. It is applicable to the standard temperature-time curve only. The fire damaged cross-section is represented by a reduced cross-section ignoring a damaged zone of thickness  $a_z$  at the fire exposed sides.  $a_z$  is assessed with reduction factors calculated in each zone of the cross section.
- Method based on estimation of curvature: this method enables the assessment of a reinforced concrete cross-section exposed to bending moment and axial load. It deals with columns where second order effects under fire are significant. This method is based on the estimation of the curvature (EN 1992-1-1, Section 5).

#### 4.4.2 Column

According to EN 1992-1-2, Annex B.3, a procedure is presented to calculate the load-bearing capacity of a reinforced concrete cross-section exposed to bending moment and axial load by the method based on estimation of curvature.

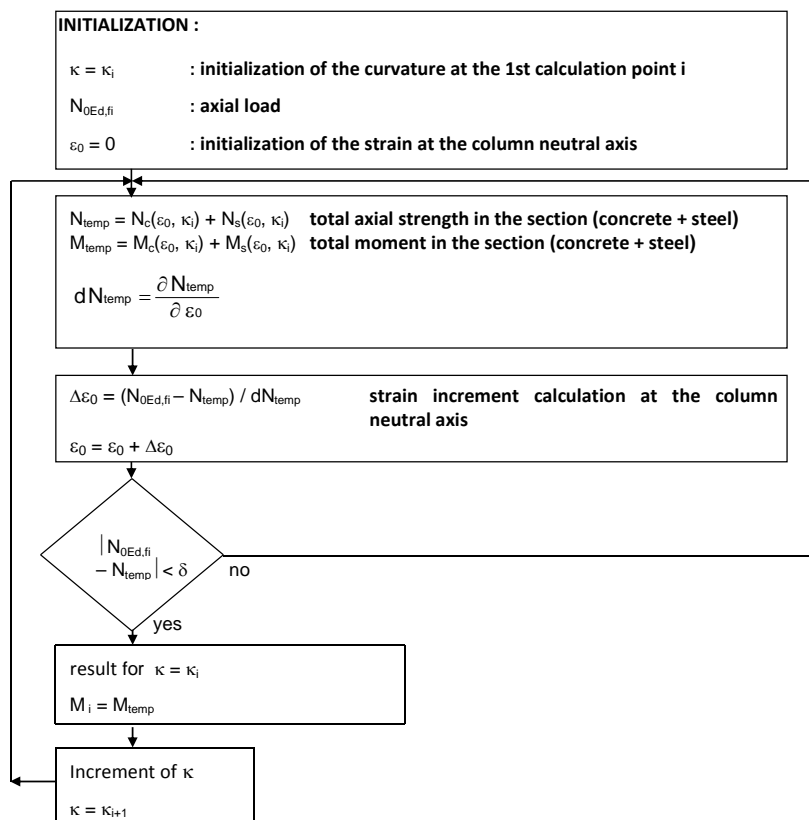
The designer should go through the following steps:

- Determine the moment-curvature diagram for  $N_{Ed,fi}$  using, for each reinforcing bar and for each concrete zone, the relevant stress-strain diagram according to EN 1992-1-2, Sec 3 “Material properties”
- Use conventional calculation methods to determine the ultimate moment capacity,  $M_{Rd,fi}$  for  $N_{Ed,fi}$  and the nominal second order moment,  $M_{2,fi}$ , for the corresponding curvature.
- Determine the remaining ultimate first order moment capacity,  $M_{0Rd,fi}$ , for the specified fire exposure and  $N_{Ed,fi}$  as the difference between ultimate moment capacity,  $M_{Rd,fi}$ , and nominal second order moment,  $M_{2,fi}$ , so calculated.
- Compare the ultimate first order moment capacity,  $M_{0Rd,fi}$ , with the design first order bending moment for fire conditions  $M_{0Ed,fi}$ .

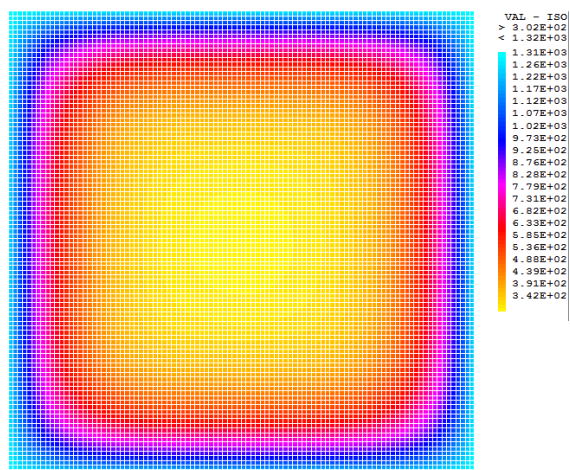


**Fig. 4.4.1** Ultimate moment capacity, second order moment and ultimate first order moment capacity as a function of the curvature (EN 1992-1-2, Annex B)

The moment – curvature diagram is built under an excel file, going through the hereafter iterative procedure (see Figure 4.4.2.), based on the strain and stress calculated with the temperature profile of the cross section (see Figure 4.4.3).



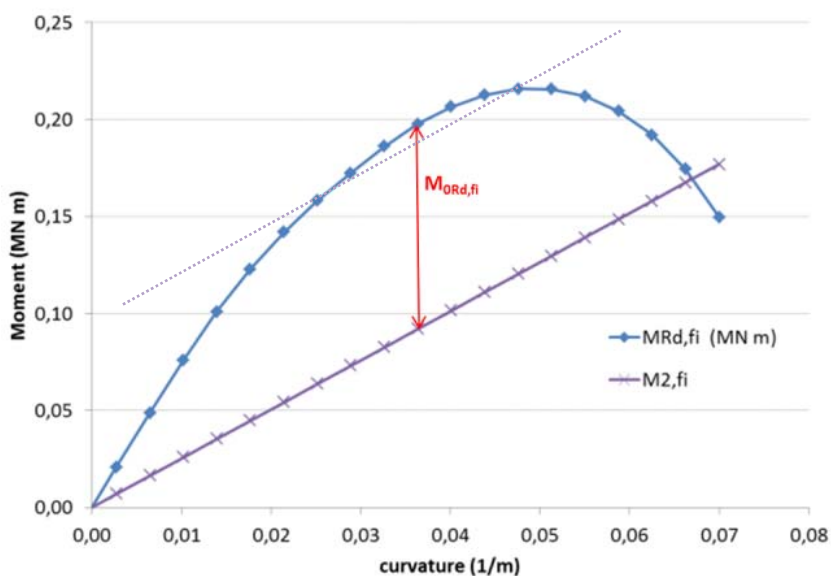
**Fig.4.4.2** Construction of the moment-curvature diagram



**Fig.4.4.3** Temperature profile in cross-section of the column (thermal analysis led on ANSYS)

As a reminder, the effective length under fire conditions,  $l_{0,fi,column}$ , may be taken as equal to  $l_{0,column}$  at normal temperature as a simplification ( $l_{0,fi,column}$  is equal to 3,1 m). The total eccentricity is equal to 3 cm and in Figure 4.4.1,  $c$  equals 10. Moreover,  $N_{0,Ed,fi,column} = 2\,630$  kN and  $M_{0,Ed,fi,column} = 78,9$  kNm.





**Fig.4.4.4** Moment –curvature diagram and nominal second order moment for a fire exposure of 240 minutes

At 240 minutes, the 4 corner reinforced bars have a temperature of 828°C; the others have a temperature of 572 °C.

The equilibrium is reached for a curvature  $1/r = 0,0364 \text{ m}^{-1}$ . The results are summarized in the following Table 4.4.1.

**Table 4.4.1** Results at 240 minutes

$1/r$	$M_{2,fi}$	$M_{Rd,fi}$	$M_{0,Rd,fi}$
$0,0364 \text{ m}^{-1}$	91,9 kNm	197,7 kNm	105,8 kNm

Thus  $M_{0,Rd,fi} = 105,8 \text{ kNm} > M_{0,Ed,fi,column} = 78,9 \text{ kNm}$ .

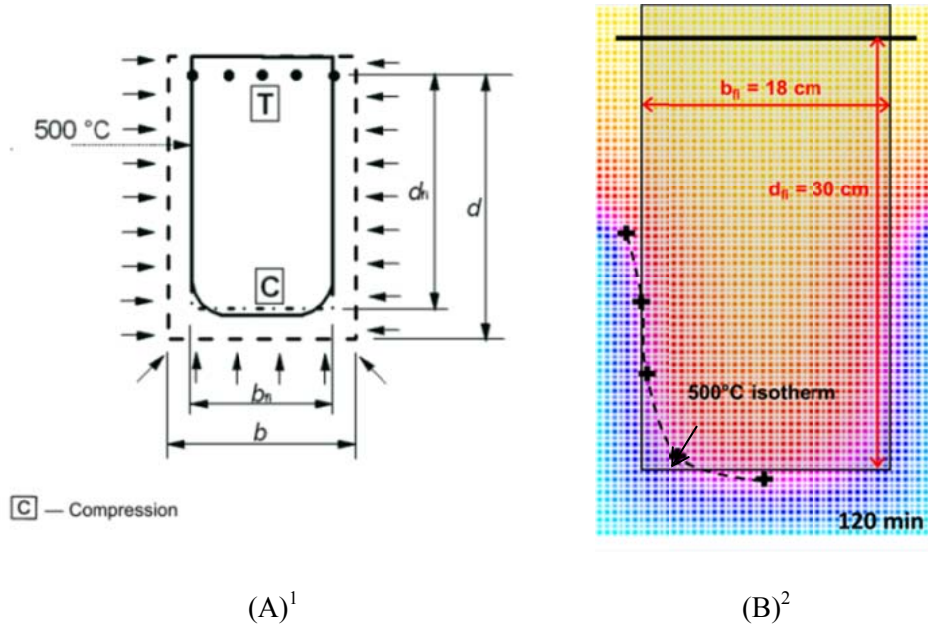
The column is assumed to assure its load-bearing capacity for 240 minutes.

#### 4.4.3 Beam

For this continuous beam, the 500°C Isotherm method which is given in EN 1992-1-2, Annex B.1 will be illustrated. The calculations are made at supports and at mid-span, according to the design moments, geometry of the beam and the reinforcing bars (see section 4.2.4.2 and Table 4.2.11).

##### 4.4.3.1 Calculation steps for bending resistance verification

- Determine the isotherm of 500°C for the specified fire exposure (in our case this is the standard fire but the method can also be applied for a parametric fire).
- Determine a new width  $b_{fi}$  and a new effective height  $d_{fi}$  of the cross-section by excluding the concrete outside the 500°C isotherm. The rounded corners of isotherms can be regarded by approximating the real form of the isotherm to a rectangle or a square.



**Fig.4.4.5** Reduced cross-section of reinforced concrete beam

- c) Determine the temperature of reinforcing bars in the tension and compression zones. The temperature of the individual reinforcing bar is taken as the temperature in the centre of the bar.
- d) Determine the reduced strength of the reinforcement due to the temperature according to EN 1992.1.1, Sec 4.2.4.3

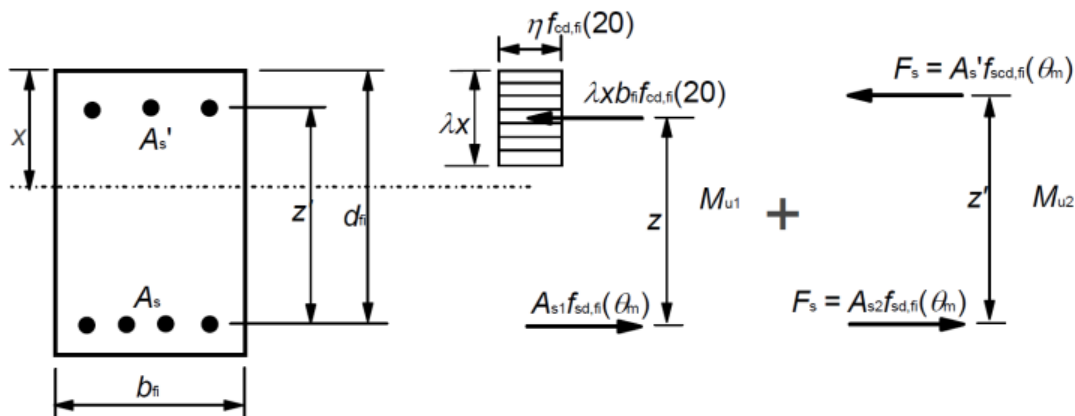
**Table 4.4.2** Temperature and reduced strength of the reinforcement at 120 minutes

at 120 minutes, $b_{fi} = 18 \text{ cm}$	$T^{\circ}\text{C}$	$k_s$	$F_s \text{ (kN)}$	
	1 $\phi$ 16	500	0,78	78,4
At mid-span	2 $\phi$ 16	679	0,28	56,3
	$\Sigma$			134,7
At intermediate support	9 $\phi$ 12	<100 $^{\circ}\text{C}$	1	508,9
At end support	7 $\phi$ 12	<100 $^{\circ}\text{C}$	1	395,8

- e) Use conventional calculation methods for the reduced cross-section for the determination of the ultimate load bearing capacity with strength of the reinforcing bars, as obtained in (d).

<sup>1</sup> A: Fire exposure on three sides with the compression zone exposed, theoretical model from EN 1992-1-2, Annex B.1

<sup>2</sup> B: isotherm and cross section for the worked example



**Fig.4.4.6** Stress distribution at ultimate limit state for a rectangular concrete cross-section with compression reinforcement (see EN 1992-1-2, Annex B.1 Figure B.2)

**Table 4.4.3** Results of the calculation at 120 minutes

	$F_{s, fi}$ (kN)	$d_{fi}$ (mm)	$z_{fi}$ (mm)	$M_{Rd, fi}$ (kNm)
<b>Mid-span</b>	134,7	356	345	46
<b>Intermediate support</b>	508,5	300	244	124
<b>End support</b>	395,8	300	256	101

$$M_{Rd, fi, 120'} = M_{Rd, fi, mid-span} + (M_{Rd, fi, inter.s up.} + M_{Rd, fi, end sup.}) / 2 > M_{0Ed, fi} \quad (4.15)$$

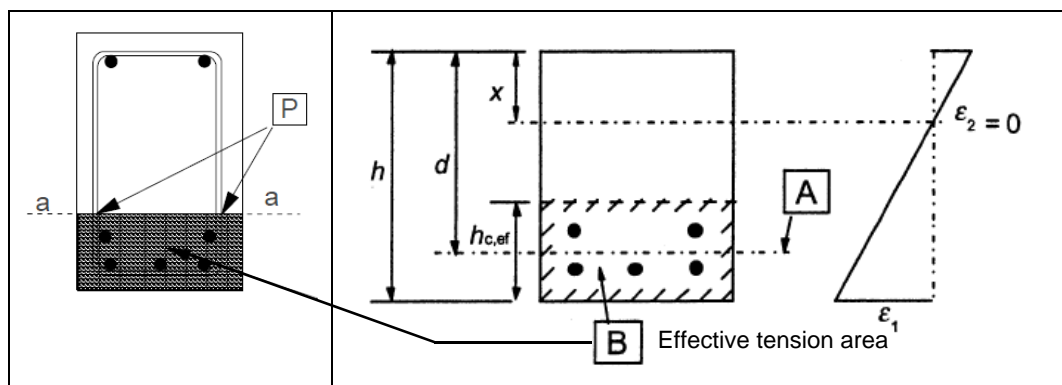
$$158,5 \text{ kNm} > 80 \text{ kNm}$$

The beam is assumed to assure its load-bearing capacity at 120 minutes.

#### 4.4.3.2 Calculation steps for shear resistance verification

- Compute the reduced geometry of the cross section, in our case EN 1992-1-2, Annex B.1 is used as previously for bending resistance.
- Determine the residual compression strength of concrete (full strength  $f_{cd, fi} = f_{cd, fi}(20)$  inside the isotherm of 500°C).
- Determine the residual tensile strength of concrete (full strength  $f_{ctd, fi} = f_{ctd, fi}(20)$  inside the isotherm of 500°C).
- Determine the effective tension area (see EN 1992-1-1, Sec 7) above delimited by the Section a-a (see Figure 4.4.7).
- Determine the reference temperature,  $\theta_p$ , in links as the temperature in the point P (intersection of Section a-a with the link)
- The reduction of design strength of steel in the links should be taken with respect to the reference temperature  $f_{sd, fi} = k_s(\theta) f_{sd}(20)$ .

- g) Calculation methods for design and assessment for shear, as in EN 1992-1-1, may be applied directly to the reduced cross-section.



**Fig.4.4.7** Determination of the effective tension area of the reference temperature  $\theta_p$  at points P (see EN 1992-1-1, Section 7 and EN 1992-1-2, Annex D)

The application of the previous steps gives the following results:

$$h_{c,ef} = \min \{ 2,5(h-d); (h-x)/3; h/2 \} \quad (4.16)$$

At 120 minutes :

$$h_{c,ef,fi} = \min \{ 2,5(400-356); (400-27)/3, 400/2 \} = \min \{ 110; 124; 200 \} = 110 \text{ mm}$$

$$q_p = 547^\circ\text{C}$$

$$k_s(547) = 0,46 \quad (\text{see EN 1992-1-2, Sec 4.2.4.3})$$

For members with vertical shear reinforcement, the shear resistance,  $V_{Rd,fi}$  is the smaller value of:

$$V_{Rd,s,fi} = \frac{A_{sw}}{s} z_{fi} f_{ywd,fi} \cot \theta \quad (4.17)$$

$$V_{Rd,max,fi} = \frac{a_{cv} b_w z_{fi} v_1 f_{cd,fi}}{\cot \theta + \tan \theta} \quad (4.18)$$

where:

$$A_{sw} = 2 \cdot \pi \cdot 3^2 = 56,5 \text{ mm}^2$$

is the cross-sectional area of the shear reinforcement

$$s = 175 \text{ mm}$$

is the spacing of the stirrups;

$$z_{fi} = 345 \text{ mm}$$

$$f_{ywd,fi} = k_s(\theta_p) \cdot 500 / 1 = 230 \text{ MPa}$$

is the design yield strength of the shear reinforcement;

$$\theta$$

is the angle between concrete compression struts and the main tension chord, it should be chosen between  $45^\circ$  and  $21,8^\circ$  ( $1 \leq \cot \theta \leq 2,5$ ), in the chapter concerning Limit State Design (ULS-SLS) of the workshop “Design of Concrete Buildings”, 20-21 October 2011, it has been chosen  $\cot \theta = 2,5$ ;

$$v_1 = 0,6(1 - f_{ck})$$

 $a_{cw}$ 

is a coefficient to take into account the stress state and equals 1 for non-prestressed structures;

$$b_{w,fi} = 180 \text{ mm}$$

(500°C isotherm method);

$$V_{Rd,s,fi} = \frac{56,5}{175} \cdot 345 \cdot 230 \cdot 2,5 = 64 \text{ kN}$$

$$V_{Rd,max,fi} = \frac{1 \cdot 180 \cdot 345 \cdot 0,54 \cdot 25}{2,5 + 0,4} = 289 \text{ kN}$$

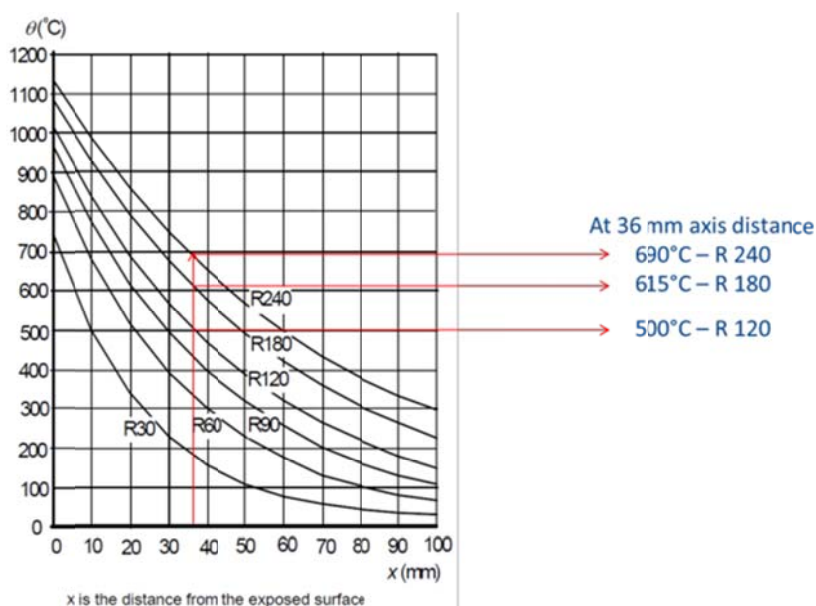
$$\Rightarrow V_{Rd,s,fi} = 64 \text{ kN} < V_{Ed,fi} = 69 \text{ kN}$$

The beam is not verified for shear resistance at 120 minutes. The spacing of the stirrups should be reduced to a minimal value of 160 mm or the stirrups diameter should be increased to  $\phi 8$  mm.

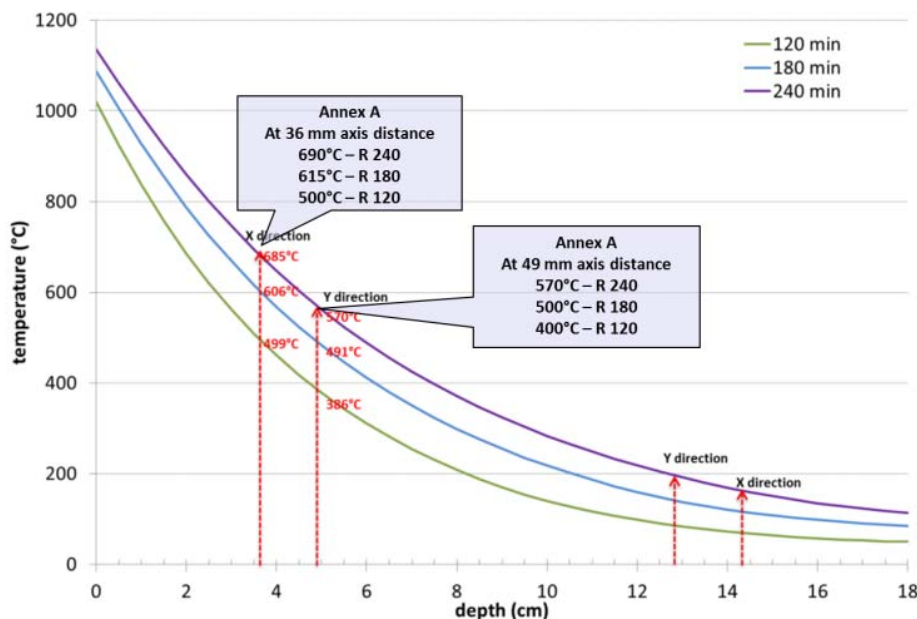
#### 4.4.4 Two-way slab

Calculations have been made in the two directions of the slab (x-direction and y-direction), according to the design moments (see Table 4.2.8 and Table 4.2.11), the geometry of the slab (see section 2) and the reinforcing bars (sections and cover, see Table 4.2.7 and Table 4.2.8).

Temperature profiles given in EN 1992-1-2, Annex A may be used for the simplified method. However, with regard to the temperature profiles in slabs, they are given for a slab whose height is 200 mm. In the present worked example, the height of the slab is 180 mm. Thus a comparison between the temperatures determined through a numerical analysis led on Code\_Aster<sup>®</sup> and the temperatures determined thanks to the temperature profiles given in EN 1992-1-2, Annex A has been performed.



**Fig.4.4.8** Determination of the temperature in the slab for the reinforcement whose axis distance is 36 mm (see EN 1992-1-2, Annex A)



**Fig.4.4.9** Temperatures profiles in the slab, comparison between Code\_Aster® (18 cm slab) and EN 1992-1-2, Annex A (20 cm slab)

As shown on Figure 4.4.9, the differences between both approaches are really slight and as a simplification Annex A from EN 1992-1-2 may be used together with the 500°C isotherm method.

However, another approach is illustrated here. The temperature has been calculated every 5 mm and the equilibrium is determined considering each layer of concrete with the corresponding temperature and reduction factor.

Due to the low lateral rigidity of the peripheral beams of the building, no bending moment will be considered at the end support of the slab.

Thus, it should be checked that:

$$M_{span,x,fi} + M_{intermediate\ support,x,fi} / 2 \geq M_{0Edx,fi}$$

$$M_{span,y,fi} + M_{intermediate\ support,y,fi} / 2 \geq M_{0Edy,fi}$$

The results of the calculation are given in Table 4.4.4 and Table 4.4.5.

**Table 4.4.4** Results of the calculations at 180 minutes fire exposure

Direction	Span		Intermediate support	
	X	Y	X	Y
Temp steel (°C)	606	491	<200	<200
$k_s$	0,456	0,8	1	1
$A_{s,span}$ (kN/m)	206,3	427,3	615,7	804,2
$f_{sd,fi}(\theta_m)$				
$z_{fi}$ (mm)	140	122	98	77
$M_{fi}$ (kNm/m)	29	52	60	62

**Table 4.4.5** Bending moments calculated for 180 minutes fire exposure

	X	Y
$M_{Rd,fi}$ (kNm/m)	59	83
$M_{0Ed,fi}$ (kNm/m)	15,7	10,5
Check	OK	OK

The load-bearing capacity of the two-way slab is assumed to be verified under fire at 180 minutes. However, the rotational capacity of the slab at the intermediate support should be checked. Some complementary information may be given in the National Annexes to perform these calculations.

## 4.5 Advanced calculation methods

Advanced calculation methods shall provide a realistic analysis of structures exposed to fire. They may be used for member analysis, analysis of parts of the structure or global analysis. In the case of analysis of parts of the structure or global analysis, indirect fire actions are considered throughout the sub-assembly or the entire structure, respectively.

Advanced calculation methods include (EN 1992-1-2, Section 4.3):

- Thermal response model (based on the theory of heat transfer and the thermal actions presented in EN 1991-1-2). Any heating curve could be used provided that the material (concrete and steel) properties are known for the relevant temperature range.
- Mechanical response model. The changes of mechanical properties with temperature should be taken into account. The effects of thermally induced strains and stresses due to temperature rise and temperature differentials shall be considered. Compatibility must be ensured and maintained between all parts of the structure (limitation of deformations). Where relevant, the geometrical non-linear effects shall be taken into account. A particular attention must be given to the boundary conditions.

However, only general principles are described in EN 1992-1-2, Section 4.3. In order to compare the different methods (tabulated data, simplified method, advanced calculation method), Code\_Aster<sup>®</sup> has been used to perform the advanced calculation. The main results are given hereafter.

### 4.5.1 Modelling description

The finite element model Code\_Aster<sup>®</sup> uses multi-fiber beam and multi-layer shell elements. The following steps are defined :

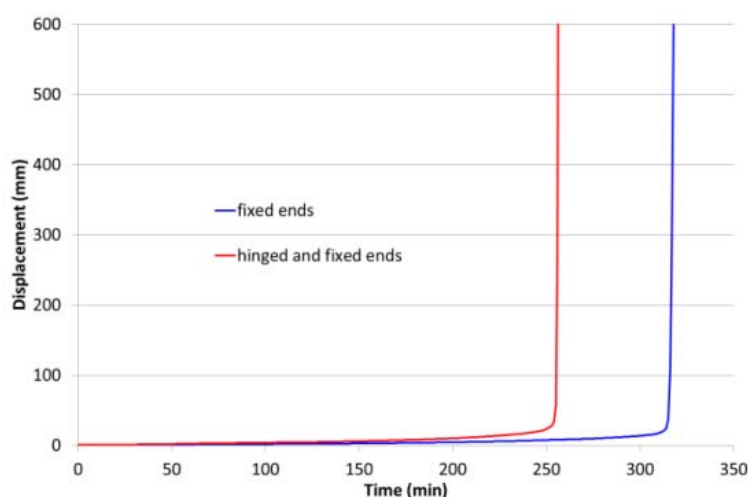
- nonlinear thermal simulation in 2D in the cross section of the elements (all the thermal properties are defined in accordance with EN 1992-1-2);
- then, the temperatures are projected on the fiber or layer of the beam or shell elements;
- finally, a transient nonlinear mechanical calculation (3D analysis) with large displacement assumptions is performed.

The concrete and steel characteristics will evolve together with the temperatures and these material responses follow the 1D models given in EN 1992-1-2, Sec 3. For the beam element (Timoshenko) and the shell elements (Love-Kirschhoff), the sections remain plane after wrapping (the total strain is linear in plane sections, the effect of transversal shear is neglected). For each fiber or layer, the mechanical strain is defined subtracting the thermal strain from the total strain and supplies the 1D nonlinear model to calculate the stress. The 1D model is used in both main directions, without any coupling (simplifying assumption).

## 4.5.2 Results

### 4.5.2.1 Column

Two boundary conditions have been tested: both fixed ends and hinged and fixed ends. The reality lies between these two cases as the floor (beam and slab) and the column of the upper floor give a rigidity. The vertical displacement is free in order to introduce the vertical loading and to allow the buckling with large displacement assumption. In the reality, the thermal expansion is partially restrained.



**Fig.4.5.1** Displacement of the column

The buckling appears at 250 minutes for hinged and fixed ends and at 320 minutes for both fixed ends.

### 4.5.2.2 Beam

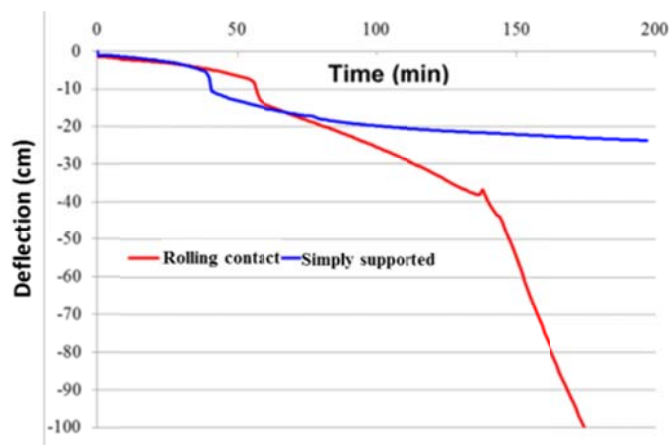
For the mechanical calculation, two boundary conditions have been considered at the end support: rolling contact or simply supported with blocked longitudinal displacements. Once again the reality lies between these two cases as the wall and edge beam will partially restrain the thermal expansion of the beam.

The deflection at mid-span (see Figure 4.5.2) shows noticeable differences between both cases. The failure of the free-end supports beam (rolling contact) appears at about 150 minutes, when the upper

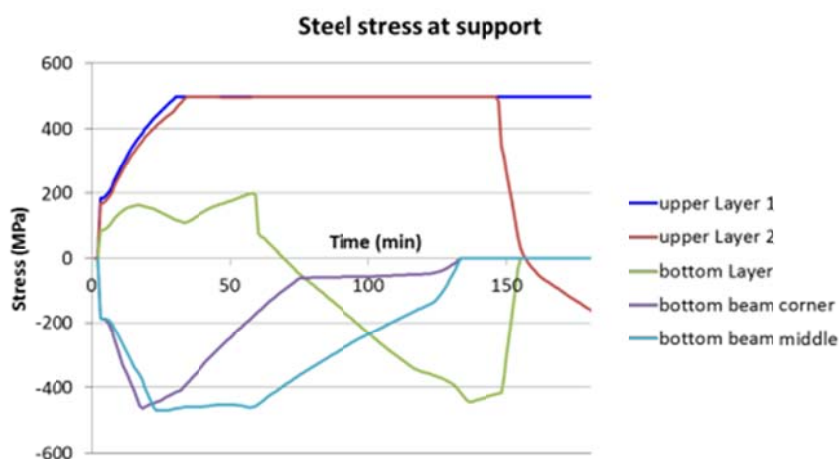


steel layer will reach the plastic condition at support (see Figure 4.5.3) which will induce a fast deflection growth.

The beam with blocked longitudinal displacements is held at the supports, the deflection is thus limited and no failure appears.



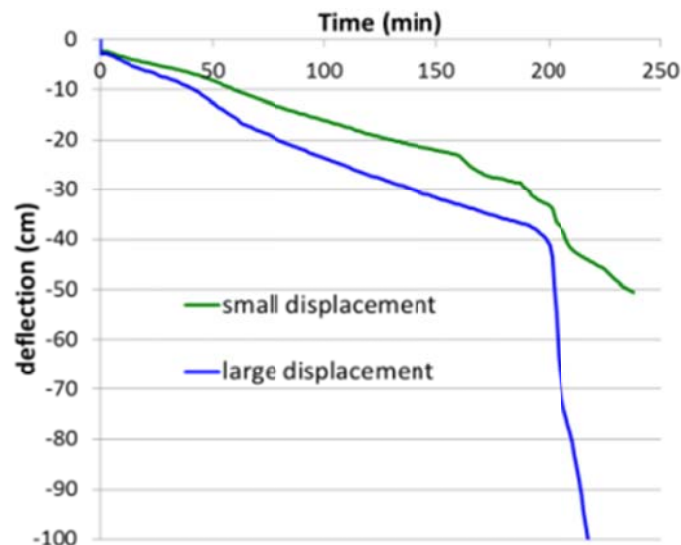
**Fig.4.5.2** Deflection of the beam



**Fig.4.5.3** Steel stress at the intermediate support of the beam

#### 4.5.2.3 Slab

The failure of the slab appears at about 200 minutes. It is interesting to observe the impact of the assumptions with regard to small and large displacements. The latest one allows a more realistic behaviour through the geometry readjustment for each time step.

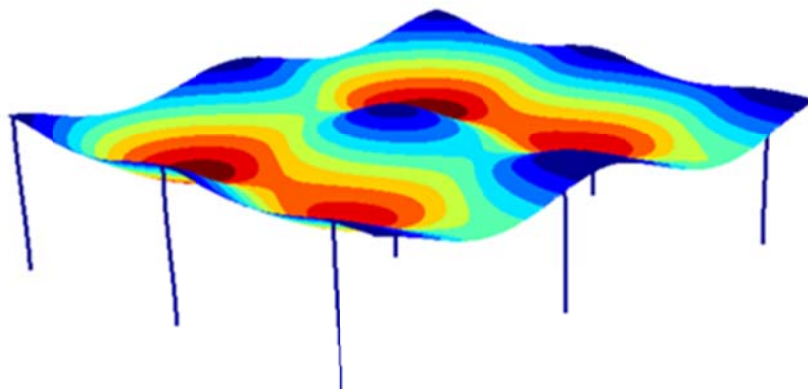


**Fig.4.5.4** deflection of the slab

#### 4.5.2.4 Beam-slab-column assembly

The modelling of the beam-slab-column assembly for one floor allows to take into account the indirect actions and the rigidity of the surrounding structure (more realistic analysis). However, the time needed for simulation is quite high. Moreover, the connections between elements are ideal (continuous, totally rigid). Columns have bottom fixed ends. The whole floor is submitted to the fire.

The failure (fast deflection growth in the middle of the slab) will appear at about 200 minutes (the deflection is about 32 cm).



**Fig.4.5.5** Shape of the deflection of the beam-slab-column assembly

#### References

EN 1990:2003. Eurocode 0: Basis of Structural Design. CEN.

EN 1991-1-1:2003. Eurocode 1: Actions on structures. Part 1-1: General actions – Densities, self-weight and imposed loads for buildings. CEN.

EN 1991-1-2:2003. Eurocode 1: Actions on structures. Part 1-2: General actions, actions on structures exposed to fire. CEN.

EN 1992-1-1:2005. Eurocode 2: Design of concrete structures. Part 1-1: General rules and rules for buildings. CEN.

EN 1992-1-2:2004. Eurocode 2: Design of concrete structures. Part 1-2: General rules - Structural fire design. CEN.

JRC Scientific&Policy report “Eurocode 2: Design of concrete buildings”, JRC, 2014



## **CHAPTER 5**

### **FIRE RESISTANCE ASSESSMENT OF MASONRY STRUCTURES. OVERVIEW AND WORKED EXAMPLE**

**Udo MEYER**

Arbeitsgemeinschaft Mauerziegel, Germany

## 5.1 Introduction

EN 1996-1-2 [1] was the last part of the Eurocodes to be finished in 2006. The number of Nationally Determined Parameters (NDPs) is rather low (10) compared with the other Eurocode parts. Unfortunately, most of the relevant material properties (thermal elongation, thermal conductivity, specific heat capacity, safety factor) as well as the tabulated data for the evaluation of the fire resistance are classified as NDPs. Other properties, e.g. stress-strain-relationships at elevated temperatures are given for a limited range of materials and these values are based on a very limited number of tests.

## 5.2 Assessment methods in EN 1996-1-2

EN 1996-1-2 gives 3 different possibilities for the assessment of the fire resistance.

- Tests according to EN 1364-1 [2] (non-load-bearing walls), EN 1365-1 [3] (load-bearing separating walls) or EN 1365-4 [4] (load-bearing columns) and classification according to EN 13501-2 [5]. Extended application of these results is possible with the European standards EN 15254-2 [6] (non-load-bearing walls) and EN 15080-12 [7] (load-bearing walls)
- Tabulated data (based on experience and/or test evidence)
- Calculation methods (simplified and advanced)

### 5.2.1 Assessment by tests

To allow for extended application (EXAP), some additional measurements required in the EXAP-standards should be carried out during the tests. The following additional information should be collected:

- Deflection of the specimen, at least in the mid-height (to allow for higher wall heights)
- Unit properties (gross density, compressive strength, moisture content, percentage of voids, web and shell thickness, combined thickness of units (i.e. the sum of the web and shell thicknesses per m wall length in the relevant cross section of the unit))
- Masonry mortar properties (gross density and compressive strength)
- Thickness of unfilled perpendicular (vertical) joints in unplastered walls
- thickness and type of plaster for plastered walls (the determination of the gross density of plaster is recommended by the author)

### 5.2.2 Assessment by tabulated data

Proposals for tabulated data are given in a note in Annex B of EN 1996-1-2.

The basis for the tabulated data were a significant number of test results on load-bearing walls according to former national test standards, mainly from Belgium, Germany and the United Kingdom.

It was not possible to come to an agreement about the precise minimum thicknesses at European level, so the tables in Annex B contain ranges of values, covering the experiences in the countries involved in the standardization process.

Nevertheless, to keep the proposal as non-committal as possible, the tables were moved to a note in Annex B so that every Member State is free to change the tables according to its needs in the National Annex. This possibility has been widely used in the first generation of the National Annexes.

The tables in Annex B are separated for the different types of masonry materials (clay, calcium silicate, concrete and lightweight concrete, autoclaved aerated concrete) and within these types for other important influencing parameters such as density, percentage of voids, applied masonry mortar and finishes (plaster).

It was agreed that there should be tabulated data for 6 different types of walls

- non-load-bearing separating (criteria EI) walls which normally show the highest fire resistance
- load-bearing separating (criteria REI) walls, where the fire resistance can depend on the level of the applied load
- load-bearing, non-separating walls (criterion R) with fire from all sides. This functionality might in the case of very slender walls improve the fire performance due to a decreased deflection but might as well lead to an earlier failure following an increased reduction of the cross-section due to deterioration of the surfaces
- load-bearing, non-separating columns (criterion R) which can be even more vulnerable than non-separating walls (length  $\geq 1,0$  m)
- load-bearing separating fire walls (criteria REI-M) with an additional mechanical impact of 3000 Nm applied 3 times after a defined time of exposure to the uniform temperature curve (a requirement mainly from Germany) and
- double leaf walls with one leaf loaded (criteria REI), a requirement mainly from the United Kingdom

Tables for load-bearing masonry contain different lines for utilization factors of 60% and 100%.

The underlying factor  $\gamma_{\text{Global}}$  (said to be in a range between 3 and 5 in EN 1996-1-2), has to be applied to  $N_{\text{Rk}}$ .

### 5.2.3 Assessment with calculation methods

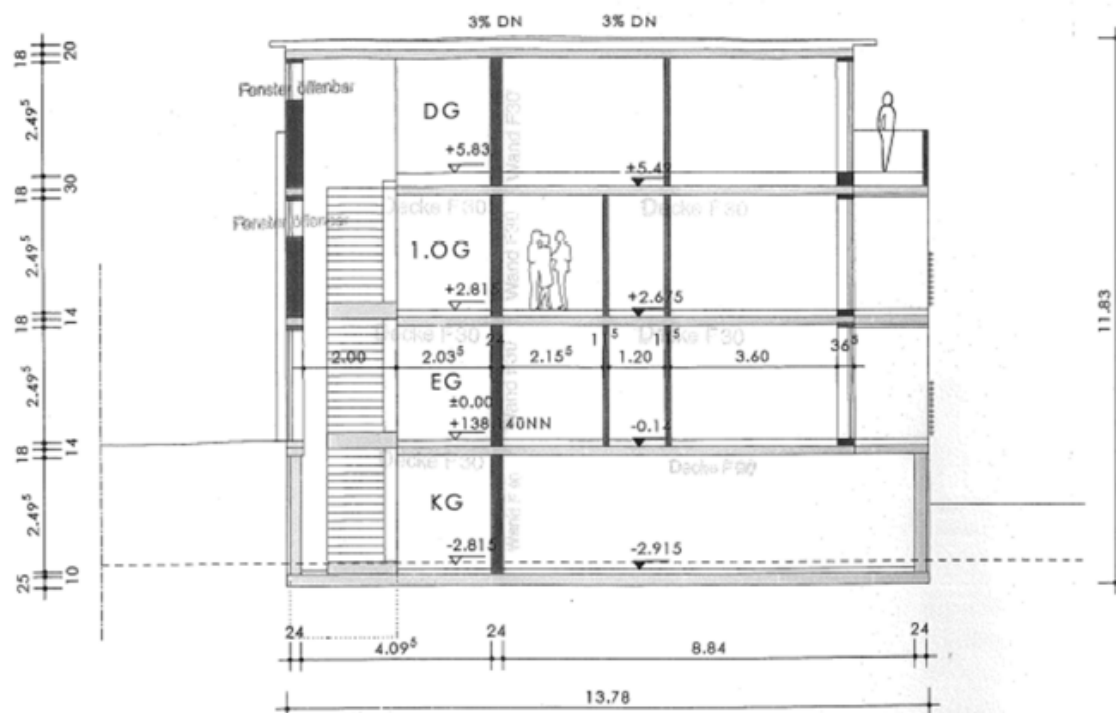
As most of the necessary material parameters for the application of the simplified (Annex C) and the advanced calculation method (Annex D) are not given in EN 1996-1-2, the application of calculation methods is excluded in most National Annexes to EN 1996-1-2 for the time being.

## 5.3 Worked example

The design rules in EN 1996-1-2 are applied to a three-storey masonry building with basement.

The design is based on tabulated data from EN 1996-1-2 and with the design rules from EN 1996-1-1 [8] and EN 1996-3 [9] respectively without any reference to National Annexes.

Figure 5.3.1 shows a cross-section through the building.



**Fig.5.3.1** Cross-section of the building

The walls are made of clay unit masonry, the external walls with additional thermal insulation. The walls thicknesses chosen in a preliminary design process were:

- 240 mm, density 1000 kg/m<sup>3</sup> + insulation for external walls
- 240 mm, density 1900 kg/m<sup>3</sup> (units for concrete infill) for internal separating walls
- 175 mm, density 900 kg/m<sup>3</sup> for internal non-separating walls

The relevant walls for the fire design are identified in the floor plan of the ground floor, see Figure 5.3.2.



## Non-separating loadbearing

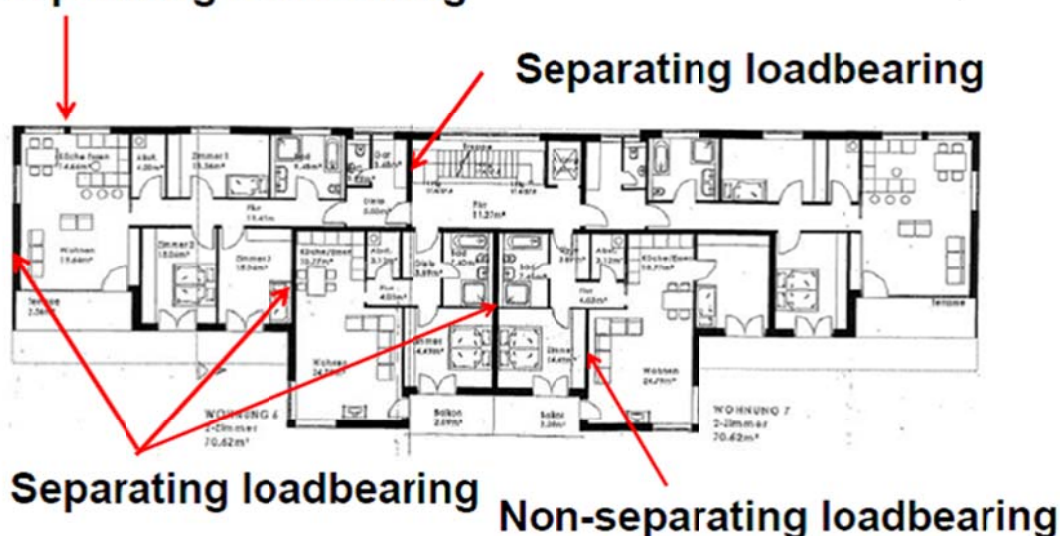


Fig.5.3.2 Walls considered for fire design in the worked example

These are:

- a separating load-bearing external walls with the highest ratio between applied load and design resistance in cold design ( $N_{Ed} = 103 \text{ kN/m}$ )
- an external column (490 x 240 mm) ( $N_{Ed} = 51 \text{ kN}$ )
- a non-separating load-bearing internal wall within an apartment ( $N_{Ed} = 123 \text{ kN/m}$ )
- a separating load-bearing internal wall between two apartments ( $N_{Ed} = 123 \text{ kN/m}$ )

### 5.3.1 Design of the external wall

Clay unit masonry with thin layer mortar, Group 2 unit according to EN 1996-1-1, Table 3.1 is considered. Compressive strength of the unit is  $f_b = 10 \text{ N/mm}^2$ .

Determination of  $f_k$  according to EN 1996-3, Annex D, D.1:

$$f_k = 3,5 \text{ N/mm}^2 \text{ (clay unit, group 2, } f_b = 10 \text{ N/mm}^2, \text{ thin layer mortar)}$$

The determination of  $f_k$  according to EN 1996-1-1, equation 3.4 and Table 3.3

$$f_k = 0,7 \cdot 100,7 = 3,51 \text{ N/mm}^2$$

gives the same value.

Determination of the design resistance  $N_{Rd}$  according to EN 1996-3, 4.2.2.2:

$$N_{Rd} = \phi_s f_d A$$

$$\phi_s = 0,85 - 0,0011(h_{ef} / t_{ef}) = 0,85 - 0,0011 \cdot (2,495 / 0,24) = 0,731$$

$$f_d = f_k / \gamma_M = 3,5 / 1,5 = 2,33 \text{ N/mm}^2$$

with

- $\phi_s$  slenderness reduction factor according to EN 1996-3, 4.2.2.3 and 4.2.2.4
- $\gamma_M$  for units category I and Class 1

$$N_{Rd} = 0,731 \cdot 2,33 \cdot 240 = 409 \text{ kN/m}$$

(the value of 349 kN/m given in the presentation was derived applying an additional factor of 0,85 taking effects of permanent loads into account)

$$N_{Ed,fi} = 0,7 N_{Ed} = 72 \text{ kN/m}$$

$$\alpha = N_{Ed,fi} / N_{Rd} = 72 / 409 = 0,18 < 0,6 .$$

The performance of the wall can be taken from EN 1996-1-2, Annex B, note, Table N.B.1.2 (clay units, separating, load-bearing, line 2.1.3 (Group 2 unit with thin layer mortar, utilization factor  $< 0,6$ , without external finish).

The wall thickness 240 mm is rated with a fire resistance of at least REI 120.

Common national requirements for external walls in that building situation range from REI 60 to REI 120.

Table 5.3.1 gives examples for the REI 90 classification of the chosen type of masonry (clay unit, group 2, thin layer mortar) in some National Annexes.

**Table 5.3.1** Examples for the REI 90 classification of the chosen type of masonry (clay unit, group 2, thin layer mortar) in some National Annexes

Country	Wall thickness in mm	Remarks
Austria	170	Values from EC not applicable, value from circolare ministeriale, with a suitable applied finish
Germany	175	
Italy	200	
Luxemburg / The Netherlands	130	
United Kingdom	215	Percentage of voids $\leq 40\%$

The test report [10] gives evidence of a REI-M90 result according to EN 1365-1 for a comparable 235 mm wall with an applied load of 77 kN/m (applied with an eccentricity of  $t/6$ ), corresponding to  $N_{Ed,fi}$ .

### 5.3.2 Design of the external column

Clay unit masonry with thin layer mortar, Group 2 unit according to EN 1996-1-1, Table 3.1 is considered. Compressive strength of unit is  $f_b = 10 \text{ N/mm}^2$ .

Determination of  $f_k$  according to EN 1996-3, Annex D, D.1:

$$f_k = 3,5 \text{ N/mm}^2 \text{ (clay unit, group 2, } f_b = 10 \text{ N/mm}^2, \text{ thin layer mortar)}$$

The determination of  $f_k$  according to EN 1996-1-1, equation 3.4 and Table 3.3

$$f_k = 0,7 \cdot 10^{0,7} = 3,51 \text{ N/mm}^2$$

gives the same value.

Determination of the design resistance  $N_{Rd}$  according to EN 1996-3, 4.2.2.2:

$$N_{Rd} = \phi_s f_d A$$

$$\phi_s = 0,85 - 0,0011(h_{ef} / t_{ef}) = 0,85 - 0,0011 \cdot (2,495 / 0,24) = 0,731$$

$$f_d = f_k / \gamma_M = 3,5 / 1,5 = 2,33 \text{ N/mm}^2$$

with

- $\phi_s$  slenderness reduction factor according to EN 1996-3, 4.2.2.3 and 4.2.2.4  
 $\gamma_M$  for units category I and Class 1

$$N_{Rd} = 0,731 \cdot 2,33 \cdot 240 \cdot 500 / 1000 = 205 \text{ kN}$$

$$N_{Ed,fi} = 0,7 N_{Ed} = 36 \text{ kN/m}$$

$$\alpha = N_{Ed,fi} / N_{Rd} = 36 / 205 = 0,18 < 0,6 .$$

The performance of the wall can be taken from EN 1996-1-2, Annex B, note, Table N.B.1.4 (clay units, non-separating, load-bearing, line 2.1.13 (Group 2 unit with thin layer mortar, utilization factor < 0,6, without external finish. Combustible thermal insulation material cannot be taken into account as an applied finish).

The column dimensions 240 mm x 490 mm are rated with a fire resistance of R180.

Common national requirements for external walls in that building situation range from R60 to R120.

The test report [11] gives evidence of a R120 result according to EN 1365-1 for a comparable column (dimensions 175 mm x 500 mm) wall with an applied load of 85 kN corresponding to 236 % of  $N_{Ed,fi}$ . The test was stopped after 125 minutes as the aim, the German requirement of R90 was exceeded by far.

### 5.3.3 Design of the internal non-separating wall

Clay unit masonry with thin layer mortar, Group 2 unit according to EN 1996-1-1, Table 3.1 is considered. Compressive strength of unit is  $f_b = 10 \text{ N/mm}^2$ .

Determination of  $f_k$  according to EN 1996-3, Annex D, D.1:

$$f_k = 3,5 \text{ N/mm}^2 \text{ (clay unit, group 2, } f_b = 10 \text{ N/mm}^2, \text{ thin layer mortar)}$$

The determination of  $f_k$  according to EN 1996-1-1, equation 3.4 and Table 3.3

$$f_k = 0,7 \cdot 10^{0,7} = 3,51 \text{ N/mm}^2$$

gives the same value.

Determination of the design resistance  $N_{Rd}$  according to EN 1996-3, 4.2.2.2

$$N_{Rd} = \phi_s f_d A$$

$$\phi_s = 0,85 - 0,0011(h_{ef} / t_{ef}) = 0,85 - 0,0011 \cdot (2,495 / 0,175) = 0,626$$

$$f_d = f_k / \gamma_M = 3,5 / 1,5 = 2,33 \text{ N/mm}^2$$

with

$\phi_s$  slenderness reduction factor according to EN 1996-3, 4.2.2.3 and 4.2.2.4

$\gamma_M$  for units category I and class 1

$$N_{Rd} = 0,626 \cdot 2,33 \cdot 175 = 256 \text{ kN}$$

$$N_{Ed,fi} = 0,7 N_{Ed} = 86 \text{ kN/m}$$

$$\alpha = N_{Ed,fi} / N_{Rd} = 86 / 256 = 0,33 < 0,6 .$$

The performance of the wall can be taken from EN 1996-1-2, Annex B, note, Table N.B.1.3 (clay units, non-separating, load-bearing, line 2.1.4 (Group 2 unit with thin layer mortar, utilization factor < 0,6, suitable external finish on both sides of the wall).

The wall thickness 170 mm is rated with a fire resistance of at least R120.

Common national requirements for internal walls in that building situation range from R60 to R120.

### 5.3.4 Design of the internal separating wall

Clay unit masonry with thin layer mortar, Group 3 unit according to EN 1996-1-1, Table 3.1 is considered. Compressive strength of unit is  $f_b = 10 \text{ N/mm}^2$ .

Determination of  $f_k$  according to EN 1996-3, Annex D, D.1:

$$f_k = 2,5 \text{ N/mm}^2 \text{ (clay unit, group 3, } f_b = 10 \text{ N/mm}^2, \text{ thin layer mortar)}$$

The determination of  $f_k$  according to EN 1996-1-1, equation 3.4 and Table 3.3

$$f_k = 0,5 \cdot 10^{0,7} = 2,51 \text{ N/mm}^2$$

gives the same value.

Determination of the design resistance  $N_{Rd}$  according to EN 1996-3, 4.2.2.2:

$$N_{Rd} = \phi_s f_d A$$

$$\phi_s = 0,85 - 0,0011(h_{ef} / t_{ef}) = 0,85 - 0,0011 \cdot (2,495 / 0,24) = 0,731$$

$$f_d = f_k / \gamma_M = 2,5 / 1,5 = 1,67 \text{ N/mm}^2$$

with

$\phi_s$  slenderness reduction factor according to EN 1996-3, 4.2.2.3 and 4.2.2.4  
 $\gamma_M$  for units category I and class 1

$$N_{Rd} = 0,731 \cdot 1,67 \cdot 240 = 292 \text{ kN}$$

$$N_{Ed,fi} = 0,7 N_{Ed} = 86 \text{ kN/m}$$

$$\alpha = N_{Ed,fi} / N_{Rd} = 86 / 292 = 0,29 < 0,6.$$

The performance of the wall can be taken from EN 1996-1-2, Annex B, note, Table N.B.1.2 (clay units, separating, load-bearing, line 4.1.4 (Group 3 unit with thin layer mortar, utilization factor < 0,6, suitable applied external finish).

The wall thickness 240 mm is rated with a fire resistance of at least REI120.

Common national requirements for external walls in that building situation range from REI60 to REI120.

## 5.4 Conclusions

EN 1996-1-2 needs to be developed in the next phase of revisions of the Eurocodes. For the time being, tests according to the EN 1363 to EN 1365 series seem to be the most reliable way for the evaluation of masonry structures, as the validity of ranges of values in a note of an Annex is and will be questionable in the future.

Nevertheless, the proposed ranges of values for tabulated fire resistances of masonry walls in the Note in Annex B lead to reasonable classifications, which are supported by national experience and recent test evidence.

As shown in the worked example, a classification of the relevant masonry walls in the typical apartment building is possible with the tables in EN 1996-1-2 without any additional information from National Annexes. The classification is supported by recent test results according to EN 1365.

Generally, the necessary wall thicknesses resulting from thermal insulating, acoustic and load-bearing requirements easily meet the requirement in the accidental fire situation.

A further harmonization of EN 1996-1-2 should be feasible in the future. One of the main obstacles seems to be the missing classification of masonry units in the unit standards and the heavily debated classification Table 3.1 in EN 1996-1-1. A new approach in that area seems to be indispensable.

## References

- [1] DIN EN 1996-1-2:2011-04. Eurocode 6: Design of masonry structures - Part 1-2: General rules - Structural fire design
- [2] EN 1364-1: 2011-11. Fire resistance tests for non-load-bearing elements – Part 1: Walls
- [3] DIN EN 1365-1:2012-12. Fire resistance tests for load-bearing elements - Part 1: Walls
- [4] EN 1365-4:1999.10. Fire resistance tests for load-bearing elements - Part 4: Columns
- [5] EN 13501-2:2010-02. Fire classification of construction products and building elements - Part 2: Classification using data from fire resistance tests, excluding ventilation services
- [6] EN 15254-2:2009-10. Extended application of results from fire resistance tests. Nonload-bearing walls- Part 2: Masonry and gypsum blocks
- [7] EN 15080-12:2011-04. Extended application of results from fire resistance tests - Part 12: Load-bearing masonry walls
- [8] EN 1996-1-1:2010-12. Design of Masonry Structures – Part 1-1: Common rules for reinforced and unreinforced masonry structures
- [9] EN 1996-3:2010-12. Eurocode 6: Design of masonry structures - Part 3: Simplified calculation methods for unreinforced masonry structures
- [10] Prüfung einer etwa 235 mm dicken, tragenden, raumabschließenden Trennwand PHLz auf Brandverhalten zur Ermittlung der Feuerwiderstandsdauer bei einseitiger Brandbeanspruchung und mit einer zusätzlichen Stoßprüfung nach DIN EN 1363-2 : 1999-10, Abschnitt 7 unter Berücksichtigung der Angaben aus DIN 4102-3 : 1977-09 zum Nachweis der Eignung als Brandwand. IBMB Braunschweig. 3466-7814 – TM 17.02.2004.
- [11] Prüfung eines ca. 175 mm dicken, tragenden Pfeilers aus PHLz nach DIN EN 1365-4 in Verbindung mit DIN EN 1363-1 zur Ermittlung der Feuerwiderstandsdauer bei vierseitiger Brandbeanspruchung. IBMB TU Braunschweig. 300-105-12 – TM. 29.11.2012

## **CHAPTER 6**

### **FIRE RESISTANCE ASSESSMENT OF TIMBER STRUCTURES**

**Andrea FRANGI**

ETH Zurich, Institute of Structural Engineering, Switzerland





## 6.1 Fire design of timber members

### 6.1.1 Basis of design

The main objective of structural fire safety measures is to restrict the spread of fire to the room of origin by guaranteeing the load-carrying capacity of the structure (Requirement on Mechanical Resistance R) and the separating function of walls and floors (Requirement on Insulation I and Integrity E) for the required period of time. The required period of time is normally expressed in terms of fire resistance, using fire exposure of the standard temperature-time curve, and is specified by the building regulations. While fire tests are still widely used for the verification of the fire resistance of timber members, calculation models are becoming more and more common. For the relevant duration of fire exposure it shall be verified that:

$$E_{d,fi} \leq R_{d,fi} \quad (6.1)$$

$E_{d,fi}$  design effects of actions in the fire situation

$R_{d,fi}$  design resistance in the fire situation

The design effects of actions in fire  $E_{d,fi}$  can be calculated according to EN 1990. For the calculation of the fire design resistance  $R_{d,fi}$  the design strength values in fire  $f_{d,fi}$  of timber are determined according to EN 1995-1-2, Section 2, Eqn. 2.1 as follows:

$$f_{d,fi} = k_{mod,fi} \frac{k_{fi} f_k}{\gamma_{M,fi}} \quad (6.2)$$

$f_{d,fi}$  design strength in fire of timber (bending strength, tensile strength, shear strength, etc.)

$f_k$  5% fractile characteristic strength properties of timber (bending strength, tensile strength, shear strength, etc.) at normal temperature

$k_{fi}$  modification factor for fire, taking into account the 20% fractiles of strength properties of timber according to EN 1995-1-2, Section 2, Table 2.1. For example

- $k_{fi} = 1,25$  for solid timber
- $k_{fi} = 1,15$  for glued-laminated timber

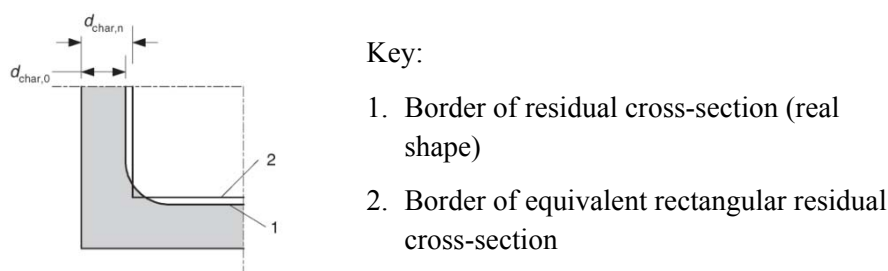
$k_{mod,fi}$  modification factor for fire taking into account the effects of temperature on the strength properties of timber

$\gamma_{M,fi}$  partial safety factor for timber in fire (recommended value  $\gamma_{M,fi} = 1,0$ )

### 6.1.2 Charring of timber

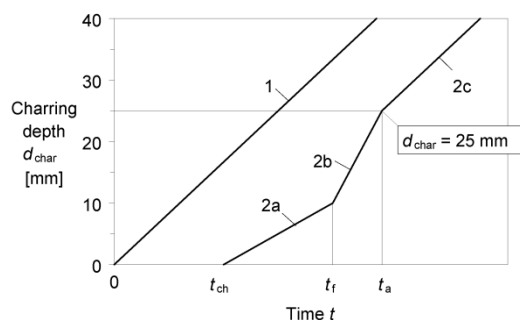
When sufficient heat is applied to wood, a process of thermal degradation (pyrolysis) takes place producing combustible gases, accompanied by a loss in mass. A charred layer is then formed on the fire-exposed surfaces and the char-layer grows in thickness as the fire progresses, reducing the cross-sectional dimensions of the timber member (Buchanan, 2000). The char-layer protects the remaining

uncharred residual cross-section against heat. In order to calculate the resistance of structural timber members exposed to fire, the loss in cross-section due to charring as well as the reduction in strength and stiffness near the charred layer due to elevated temperature has to be considered. For timber surfaces unprotected throughout the time of fire exposure, the residual cross-section can be calculated by assuming a charring rate constant with time (König, 2005). As a basic value, the one-dimensional charring rate  $\beta_0$  is usually taken as the value observed for one-dimensional heat transfer under ISO-fire exposure in a semi-infinite timber slab. EN 1995-1-2 gives a value of  $\beta_0 = 0,65$  mm/min for softwood confirmed by several experimental studies (Schaffer, 1967, Frangi and Fontana, 2003). In order to take into account the effects of corner roundings and fissures and to simplify the calculation of cross-sectional properties (area, section modulus and second moment of area) by assuming an equivalent rectangular residual cross-section, design codes generally define charring rates greater than the one-dimensional charring rate. The charring rate including these effects is called the notional charring rate  $\beta_n$  according to EN 1995-1-2 and for example for solid timber a value of  $\beta_n = 0,8$  mm/min, while for glued laminated timber a value of  $\beta_n = 0,7$  mm/min can be assumed. Figure 6.1.1 shows the definition of charring depth  $d_{char,0}$  for one-dimensional charring and notional charring depth  $d_{char,n}$ .



**Fig.6.1.1** Charring depth  $d_{char,0}$  for one-dimensional charring and notional charring depth  $d_{char,n}$  (König, 2005)

For protected timber surfaces different charring rates should be applied during different phases of fire exposure (König and Walleij, 1999). Figure 6.1.2 gives the simplified model adopted by EN 1995-1-2 when start of charring  $t_{ch}$  occurs before the failure time  $t_f$  of the cladding. Phase 2a describes the charring of timber until failure of the protective claddings and is characterised by a reduced charring rate. After the claddings have fallen off, charring is assumed to take place at double the rate of initially unprotected surfaces. The main physical reasons for the increased charring rate observed after failure of the cladding is that, at that time, the fire temperature is already at a high level while no protective char layer exists to reduce the effect of the temperature (Frangi et al., 2008). The protection provided by the char layer is assumed to grow progressively until its thickness has reached 25 mm. Then the charring rate decreases to the value for initially unprotected surfaces. For simplicity, the 25 mm criterion is adopted for both the one-dimensional and notional charring depth. The simplified model can be used for protective claddings made of gypsum plasterboards type F according to EN 520. For protective claddings made of wood-based panels or wood panelling as well as for gypsum plaster-boards type A or H according to EN 520 the same model can be used, except that the phase 2a does not occur since it can be assumed that the start of charring  $t_{ch}$  occurs at the same time as the failure  $t_f$  of the cladding.



Key:

1. Relationship for initially unprotected members for charring rate  $\beta_0$  and  $\beta_n$
2. Relationship for initially protected members where charring  $t_{ch}$  starts before failure of protection  $t_f$ :
  - 2a. Charring starts at  $t_{ch}$  at a reduced rate when protection is still in place
  - 2b. After protection has fallen off charring increased at double rate  $\beta_0$  and  $\beta_n$
  - 2c. After char depth exceeds 25 mm charring rate reduces to  $\beta_0$  and  $\beta_n$

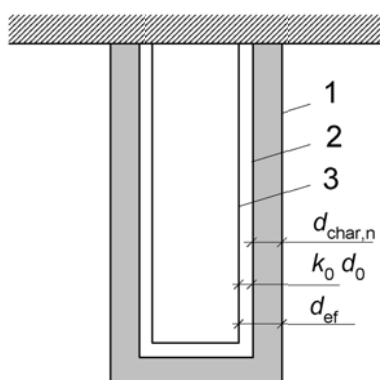
**Fig.6.1.2** General description of charring for initially protected timber surfaces according to EN 1995-1-2 when start of charring  $t_{ch}$  occurs before failure (i.e. fall off) of the fire protective cladding  $t_f$  (line 2). Line 1 is for initially unprotected timber surfaces.

EN 1995-1-2 gives rules for the calculation of start of charring as well as failure times for fire protective claddings made of wood-based panels or wood panelling as well as for gypsum plasterboards type A or H according to EN 520 (gypsum plasterboards type A are regular common boards while gypsum plasterboards type H have a reduced water absorption rate). For this type of fire protective claddings it can be assumed that the start of charring  $t_{ch}$  corresponds to the failure time  $t_f$  of the fire protective claddings, i.e.  $t_f = t_{ch}$ . Gypsum plasterboards type F according to EN 520 with improved core cohesion at high temperatures typically remain in place after the protected timber start charring, so that  $t_f > t_{ch}$ . EN 1995-1-2 gives rules for the calculation of start of charring of gypsum plasterboards type F as well. Failure of gypsum plasterboards type F may take place due to thermal degradation of the boards or pull-out/pull-through failure of fasteners. Since only few generic data are available for the failure due to thermal degradation, failure times of gypsum plasterboards type F is usually determined by testing (Östman et al., 2010).

### 6.1.3 Simplified design method

Fire reduces the cross-section and the stiffness and strength of the heated timber close to the burning surface. The stiffness and strength of wood significantly decrease with increasing temperature (Gerhards, 1982, Källsner and König, 2000, König 2000). At a temperature of about 200°C wood begins to undergo rapid thermal decomposition. The pyrolysis zone can be located between 200°C and 300°C; the front of the char is found at a temperature of about 300°C (Schaffer, 1967, König, 2005). Because of the good insulating behaviour of the char-layer and the timber, typical temperature profiles through burning timber members exhibit a steep temperature gradient. The temperature-dependent reduction in strength and stiffness near the charred layer can be considered in different ways. EN 1995-1-2 gives two alternative simplified methods: the “Reduced cross-section method” and the “Reduced properties method”. The “Reduced cross-section method” considers the strength and stiffness reduction near the charred layer by adding an additional depth  $k_0 d_0$  (called zero strength layer) to the charred layer  $d_{char,n}$  (see Figure 6.1.3). It is assumed that this zero strength layer is built up linearly with time during the first 20 minutes of fire exposure. This method permits the designer to use strength and stiffness properties for normal temperature for the resulting effective cross-section.

Thus the temperature-dependent reduction factor is therefore taken as  $k_{mod,fi} = 1,0$  for the effective cross-section.



Key:

1. Initial surface of member
2. Border of residual cross-section
3. Border of effective cross-section

$d_{char,n}$  notional charring depth  
 $d_0$  zero strength layer:  $d_0 = 7 \text{ mm}$   
 $k_0$   $k_0 = 1,0$  for  $t \geq 20$  minutes;  
 $k_0 = t/20$  for  $t < 20$  minutes  
 $t$  time of fire exposure  
 $d_{ef}$  effective charring depth

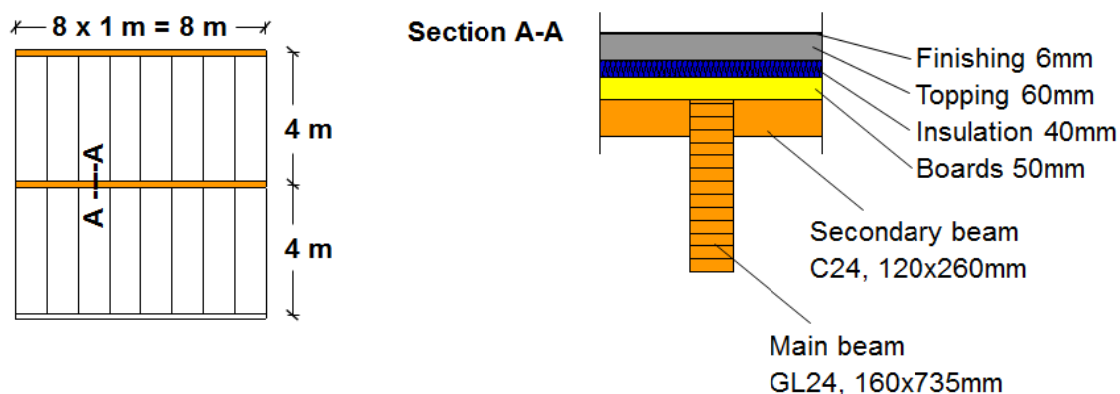
**Fig.6.1.3** Definition of residual cross-section and effective cross-section (König, 2005)

The “Reduced properties method” takes into account the influence of the temperature reducing the timber stiffness and strength properties of the residual cross-section by a temperature-dependent reduction factor  $k_{mod,fi}$ . The reduction of the timber strength and stiffness properties were derived using test results (Glos and Henrici, 1990), which do not well reflect the physical behaviour of timber in fire (König, 2000, König, 2005).

## 6.1.4 Worked examples

### 6.1.4.1 Introduction

Figure 6.1.4 shows the geometry of a timber slab that consists of main timber beams with a span of 8 m and secondary timber beams with a span of 4 m. The static system is simply supported beam.



**Fig.6.1.4** Geometry and static system of a timber slab

**The material properties are defined as follows:**

Secondary beam

Solid timber C24 according to EN 338

$$f_{m,k} = 24 \text{ N/mm}^2$$

$$f_{c,0,k} = 21 \text{ N/mm}^2$$

$$E_{\text{mean}} = 11000 \text{ N/mm}^2$$

Main beam

Glued laminated timber GL24h according to EN 14080

$$f_{m,k} = 24 \text{ N/mm}^2$$

**The actions are defined as follows:**

Permanent loads

Secondary beam	0,17 kN/m <sup>2</sup>
Main beam	0,17 kN/m <sup>2</sup>
Finishing	0,09 kN/m <sup>2</sup>
Topping	1,32 kN/m <sup>2</sup>
Insulation	0,06 kN/m <sup>2</sup>
Boards	0,28 kN/m <sup>2</sup>
Partitions	1,00 kN/m <sup>2</sup>

Variable loads:

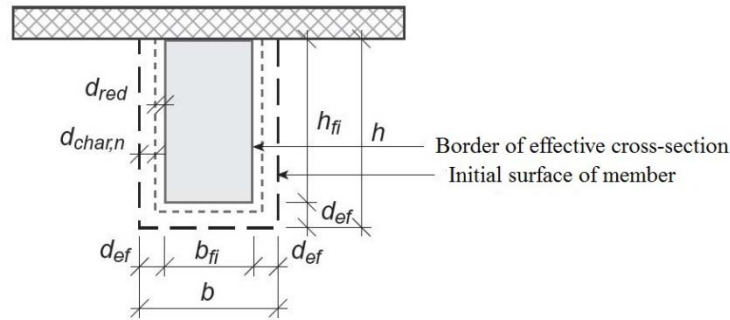
Residential	2,00 kN/m <sup>2</sup>
-------------	------------------------

According to EN 1991-1-2, Section 4, the relevant effects of actions  $E_{d,fi}$  during fire exposure shall be obtained from the combinations of actions for accidental design situation in accordance with EN 1990, using the quasi-permanent value  $\psi_{2,1}Q_1$  or the frequent value  $\psi_{1,1}Q_1$  of the variable action  $Q_1$ . In the following examples the recommended quasi-permanent value  $\psi_{2,1} = 0,3$  for residential buildings is used.

**6.1.4.2 Fire design of the secondary unprotected timber beam for 30 minutes fire resistance**

- It is assumed a fire exposure on 3 sides.
- Required fire resistance:  $t_{\text{req}} = 30 \text{ min}$
- Notional charring rate:  $\beta_n = 0,8 \text{ mm/min}$  (solid timber)
- Design bending strength in fire:  $f_{m,d,fi} = k_{fi} f_{m,k} = 1,25 \cdot 24,0 = 30,0 \text{ N/mm}^2$

**Calculation of the section modulus  $W_{fi}$  of the effective cross-section (Figure 6.1.5):**



**Fig.6.1.5** Effective cross-section of the beam

$$b_{fi} = 120 - 2 \cdot (30 \cdot 0,8 + 7) = 58 \text{ mm}$$

$$h_{fi} = 260 - (30 \cdot 0,8 + 7) = 229 \text{ mm}$$

$$W_{fi} = \frac{58 \cdot 229^2}{6} = 506,9 \cdot 10^3 \text{ mm}^3$$

**Calculation of the maximum design bending moment and the maximum design bending stress:**

$$M_{d,fi} = \frac{q_{d,fi} \ell^2}{8} = \frac{(0,17 + 0,09 + 1,32 + 0,06 + 0,28 + 1,0 + 0,3 \cdot 2,0) \cdot 1,0 \cdot 4,0^2}{8} = 7,0 \text{ kNm}$$

$$\sigma_{d,fi} = \frac{M_{d,fi}}{W_{fi}} = \frac{7,0 \cdot 10^6}{506,9 \cdot 10^3} = 13,9 \text{ N/mm}^2$$

**Verification of the design bending fire resistance:**

$$\sigma_{d,fi} = 13,9 \text{ N/mm}^2 \leq f_{m,d,fi} = 30,0 \text{ N/mm}^2 \text{ OK}$$

#### 6.1.4.3 Fire design of the main unprotected timber beam for 30 minutes fire resistance

- It is assumed a fire exposure on 3 sides.
- Required fire resistance:  $t_{req} = 30 \text{ min}$
- Notional charring rate:  $\beta_n = 0,7 \text{ mm/min}$  (glued laminated timber)

Design bending strength in fire:

$$f_{m,d,fi} = k_{fi} f_{m,k} = 1,15 \cdot 24,0 = 27,6 \text{ N/mm}^2$$

**Calculation of the section modulus  $W_{fi}$  of the effective cross-section (see Figure 6.1.5):**

$$b_{fi} = 160 - 2 \cdot (30 \cdot 0,7 + 7) = 104 \text{ mm}$$

$$h_{fi} = 735 - (30 \cdot 0,7 + 7) = 707 \text{ mm}$$

$$W_{fi} = \frac{104 \cdot 707^2}{6} = 8664 \cdot 10^3 \text{ mm}^3$$

**Calculation of the maximum design bending moment and the maximum design bending stress:**

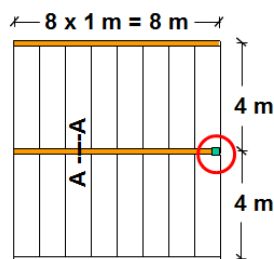
$$M_{d,fi} = \frac{q_{d,fi} \ell^2}{8} = \frac{(0,17 + 0,17 + 0,09 + 1,32 + 0,06 + 0,28 + 1,0 + 0,3 \cdot 2,0) \cdot 4,0 \cdot 8,0^2}{8} = 118,1 \text{ kNm}$$

$$\sigma_{d,fi} = \frac{M_{d,fi}}{W_{fi}} = \frac{118,1 \cdot 10^6}{8664 \cdot 10^3} = 13,6 \text{ N/mm}^2$$

**Verification of design bending fire resistance:**

$$\sigma_{d,fi} = 13,6 \text{ N/mm}^2 \leq f_{m,d,fi} = 27,6 \text{ N/mm}^2 \Rightarrow \text{OK}$$

#### 6.1.4.4 Fire design of the unprotected timber column for 30 minutes fire resistance



**Fig.6.1.6** Location of the column

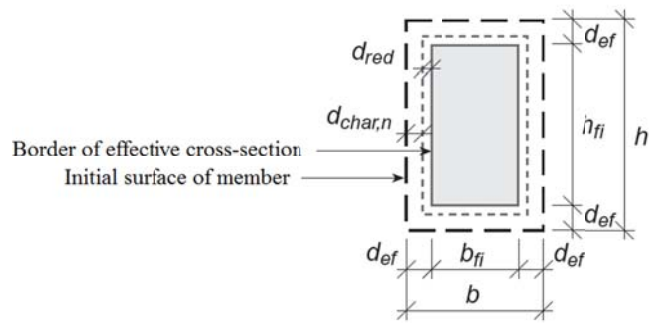
- Cross-section of the timber column: 160x160 mm
- Solid timber C24
- It is assumed a fire exposure on 4 sides.
- Required fire resistance:  $t_{req} = 30 \text{ min}$
- Notional charring rate:  $\beta_n = 0,8 \text{ mm/min}$  (solid timber)

**Calculation of the area  $A_{fi}$  of the effective cross-section (see Figure 6.1.7):**

$$b_{fi} = 160 - 2 \cdot (30 \cdot 0,8 + 7) = 98 \text{ mm}$$

$$h_{fi} = 160 - 2 \cdot (30 \cdot 0,8 + 7) = 98 \text{ mm}$$

$$A_{fi} = 98 \cdot 98 = 9604 \text{ mm}^2$$



**Fig.6.1.7** Effective cross-section of the column

**Calculation of the design normal force and the design compressive stress:**

$$N_{d,fi} = \frac{(0,17 + 0,17 + 0,09 + 1,32 + 0,06 + 0,28 + 1,0 + 0,3 \cdot 2,0) \cdot 4,0 \cdot 8,0}{2} = 59,0 \text{ kN}$$

$$\sigma_{d,fi} = \frac{N_{d,fi}}{A_{fi}} = \frac{59,0 \cdot 10^3}{9604} = 6,1 \text{ N/mm}^2$$

**Calculation of buckling coefficient  $k_{c,fi}$  for the effective cross-section:**

Assumed buckling length:  $\ell = 3,0 \text{ m}$

Radius of gyration:

$$i_{fi} = \sqrt{\frac{I_{fi}}{A_{fi}}} = \sqrt{\frac{98 \cdot 98^3 / 12}{98 \cdot 98}} = 28,3 \text{ mm}$$

Slenderness ratio:

$$\lambda_{fi} = \frac{\ell}{i_{fi}} = \frac{3000}{28,3} = 106,0$$

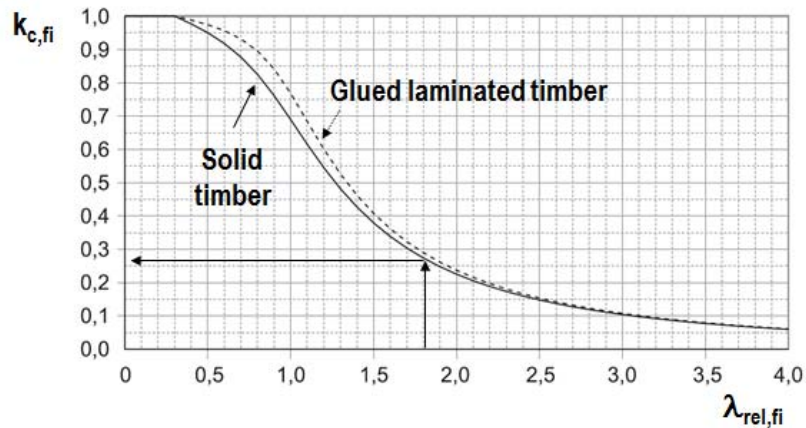
Relative slenderness ratio:

$$\lambda_{rel,fi} = \frac{\lambda_{fi}}{\pi} \sqrt{\frac{f_{c,0,k}}{E_{0,05}}} = \frac{\lambda_{fi}}{\pi} \sqrt{\frac{f_{c,0,k}}{2/3 E_{mean}}} = \frac{106,0}{3,14} \cdot \sqrt{\frac{21}{2/3 \cdot 11000}} = 1,8$$

Buckling coefficient:

$$k_{c,fi} = 0,27$$





**Fig.6.1.8** Buckling curve

Design compressive strength in fire:

$$f_{c,0,d,fi} = k_{fi} f_{c,0,k} k_{c,fi} = 1,25 \cdot 21,0 \cdot 0,27 = 7,1 \text{ N/mm}^2$$

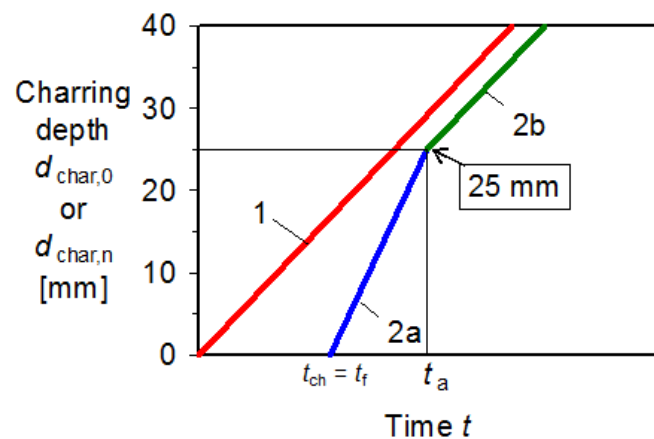
Verification of design buckling fire resistance:

$$\sigma_{d,fi} = 6,1 \text{ N/mm}^2 \leq f_{c,0,d,fi} = 7,1 \text{ N/mm}^2 \Rightarrow \text{OK}$$

#### 6.1.4.5 Fire design of the protected timber column for 60 minutes fire resistance

In order to increase the fire resistance the timber column (Figure 6.1.6) is protected by gypsum plasterboards.

- Cross-section of timber column: 160x160 mm
- Solid timber C24
- It is assumed a fire exposure on 4 sides.
- Required fire resistance:  $t_{\text{req}} = 60 \text{ min}$
- Notional charring rate:  $\beta_n = 0,8 \text{ mm/min}$  (solid timber)



**Fig.6.1.9** "Charring-time" relationship

**Protection with gypsum plasterboard type A according to EN 520, single layer, 18 mm thick.**

$$t_{ch} = 2,8h_p - 14 = 2,8 \cdot 18 - 14 = 36 \text{ min}$$

$$t_a = 36 + \frac{25}{2\beta_n} = 36 + \frac{25}{2 \cdot 0,8} = 51,5 \text{ min}$$

**Calculation of the area  $A_{fi}$  of the effective cross-section (see Figure 6.1.7):**

$$b_{fi} = 160 - 2 \cdot (25 + (60 - 51,5) \cdot 0,8 + 7) = 82,4 \text{ mm}$$

$$h_{fi} = 160 - 2 \cdot (25 + (60 - 51,5) \cdot 0,8 + 7) = 82,4 \text{ mm}$$

$$A_{fi} = 82,4 \cdot 82,4 = 6790 \text{ mm}^2$$

**Calculation of design normal force and design compressive stress:**

$$N_{d,fi} = \frac{(0,17 + 0,17 + 0,09 + 1,32 + 0,06 + 0,28 + 1,0 + 0,3 \cdot 2,0) \cdot 4,0 \cdot 8,0}{2} = 59,0 \text{ kN}$$

$$\sigma_{d,fi} = \frac{N_{d,fi}}{A_{fi}} = \frac{59,0 \cdot 10^3}{6790} = 8,7 \text{ N/mm}^2$$

**Calculation of buckling coefficient  $k_{c,fi}$  for the effective cross-section:**

Assumed buckling length:  $\ell = 3,0 \text{ m}$

Radius of gyration:

$$i_{fi} = \sqrt{\frac{I_{fi}}{A_{fi}}} = \sqrt{\frac{82,4 \cdot 82,4^3 / 12}{82,4 \cdot 82,4}} = 23,8 \text{ mm}$$

Slenderness ratio:

$$\lambda_{fi} = \frac{\ell}{i_{fi}} = \frac{3000}{23,8} = 126,0$$

Relative slenderness ratio:

$$\lambda_{rel,fi} = \frac{\lambda_{fi}}{\pi} \sqrt{\frac{f_{c,0,k}}{E_{0,05}}} = \frac{\lambda_{fi}}{\pi} \sqrt{\frac{f_{c,0,k}}{2/3 \cdot E_{mean}}} = \frac{126,0}{3,14} \cdot \sqrt{\frac{21}{2/3 \cdot 11000}} = 2,1$$

Buckling coefficient:

$$k_{c,fi} = 0,20$$

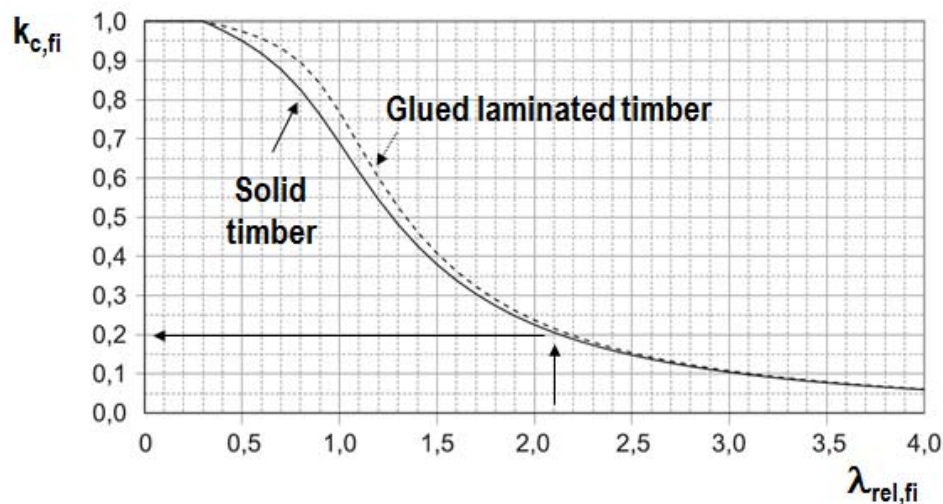


Fig.6.1.10 Buckling curve

**Design compressive strength in fire:**

$$f_{c,0,d,fi} = k_{fi} f_{c,0,k} k_{c,fi} = 1,25 \cdot 21,0 \cdot 0,20 = 5,3 \text{ N/mm}^2$$

**Verification of design buckling fire resistance:**

$$\sigma_{d,fi} = 8,7 \text{ N/mm}^2 \leq f_{c,0,d,fi} = 5,3 \text{ N/mm}^2 \quad \Rightarrow \text{Not OK } \otimes$$

#### 6.1.4.6 Fire design of the unprotected timber column with increased cross-section for 60 min. fire resistance

In order to increase the fire resistance the cross-section of the timber column (Figure 6.1.6) is increased.

- Cross-section of timber column: 210x210 mm (increased cross-section by charring depth  $d_{char,n} = 30 \cdot 0,8 = 24 \text{ mm}$ )
- Solid timber C24
- It is assumed a fire exposure on 4 sides.
- Required fire resistance:  $t_{req} = 60 \text{ min}$
- Notional charring rate:  $\beta_n = 0,8 \text{ mm/min}$  (solid timber)

**Calculation of the area  $A_{fi}$  of the effective cross-section (Figure 6.1.7):**

$$b_{fi} = 210 - 2 \cdot (60 \cdot 0,8 + 7) = 100 \text{ mm}$$

$$h_{fi} = 210 - 2 \cdot (60 \cdot 0,8 + 7) = 100 \text{ mm}$$

$$A_{fi} = 100 \cdot 100 = 10000 \text{ mm}^2$$

**Calculation of design normal force and design compressive stress:**

$$N_{d,fi} = \frac{(0,17 + 0,17 + 0,09 + 1,32 + 0,06 + 0,28 + 1,0 + 0,3 \cdot 2,0) \cdot 4,0 \cdot 8,0}{2} = 59,0 \text{ kN}$$

$$\sigma_{d,fi} = \frac{N_{d,fi}}{A_{fi}} = \frac{59,0 \cdot 10^3}{10000} = 5,9 \text{ N/mm}^2$$

**Calculation of buckling coefficient  $k_{c,fi}$  for the effective cross-section:**

Assumed buckling length:  $\ell = 3,0 \text{ m}$

Radius of gyration:

$$i_{fi} = \sqrt{\frac{I_{fi}}{A_{fi}}} = \sqrt{\frac{100 \cdot 100^3 / 12}{100 \cdot 100}} = 28,9 \text{ mm}$$

Slenderness ratio:

$$\lambda_{fi} = \frac{\ell}{i_{fi}} = \frac{3000}{28,9} = 103,8$$

Relative slenderness ratio:

$$\lambda_{rel,fi} = \frac{\lambda_{fi}}{\pi} \sqrt{\frac{f_{c,0,k}}{E_{0,05}}} = \frac{\lambda_{fi}}{\pi} \sqrt{\frac{f_{c,0,k}}{2/3 \cdot E_{mean}}} = \frac{103,8}{3,14} \cdot \sqrt{\frac{21}{2/3 \cdot 11000}} = 1,8$$

Buckling coefficient (Figure 6.1.8):

$$k_{c,fi} = 0,27$$

**Design compressive strength in fire:**

$$f_{c,0,d,fi} = k_{fi} f_{c,0,k} k_{c,fi} = 1,25 \cdot 21,0 \cdot 0,27 = 7,1 \text{ N/mm}^2$$

**Verification of design buckling fire resistance:**

$$\sigma_{d,fi} = 5,9 \text{ N/mm}^2 \leq f_{c,0,d,fi} = 7,1 \text{ N/mm}^2 \Rightarrow \text{OK}$$

## 6.2 Fire design of timber connections

### 6.2.1 Background

The rules given in EN 1995-1-2 apply to symmetrical three-member connections made with nails, bolts, dowels, split-ring connectors, shear-plate connectors or toothed plate connectors. The simplified rules of EN 1995-1-2 allow the fire design of connections by fulfilling minimal geometrical

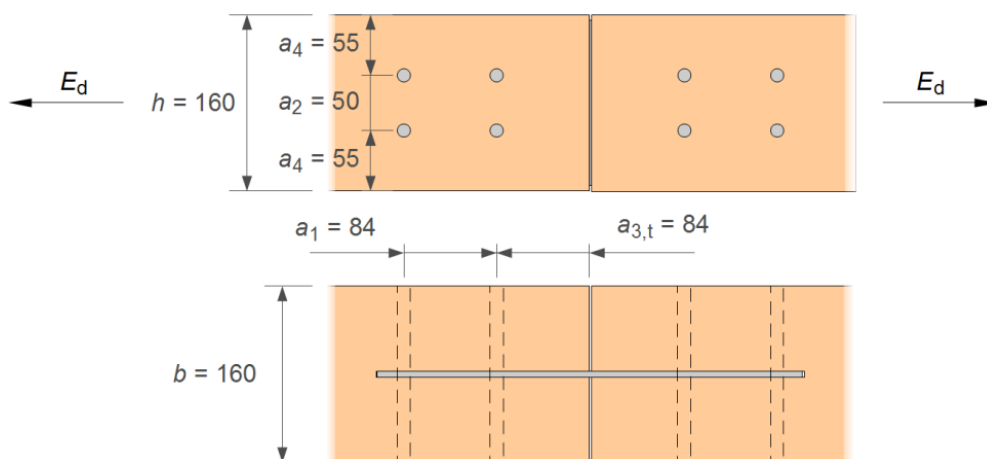
requirements. It is stated that unprotected connections designed for normal temperature conditions according to EN 1995-1-1 exhibit a fire resistance of 20 minutes (dowels) or 15 minutes (all other types mentioned above). For greater fire resistances, increased member sizes or applied protection are necessary.

An alternative strategy to increase the fire resistance of a connection is to reduce the load, or to reduce the load together with increased member sizes or applied protection. The relative load-carrying capacity vs. time is given as a one-parameter exponential model which fits experimental results fairly well (König, 2005). The parameters  $k$  describing the exponential functions for different connections were determined using the test results given in (Norén, 1996, Dhima, 1999, Kruppa et al., 2000). The number of test results is still limited. Ongoing and future research will lead to improved design rules (Östman et al., 2010).

## 6.2.2 Worked examples

### 6.2.2.1 Introduction

A steel-to-timber dowelled connection with an internal steel plate is used to connect two 160x160 mm glued laminated timber members, as shown in Figure 6.2.1. The strength class of the glued laminated timber members is GL24h ( $\rho_k = 380 \text{ kg/m}^3$ ) according to EN 14080. The required fire resistance is 30 minutes (R30). A 5 mm thick steel plate and dowels with diameter of 12 mm (strength class 6.8 with a tensile strength of  $600 \text{ N/mm}^2$ ) are used. The connection is subjected to a design tensile force  $E_d$  of 40 kN at normal temperature.



**Fig.6.2.1** Steel-to-timber dowelled connection with an internal steel plate (all dimensions in mm)

The design of the connection at normal temperature according to EN 1995-1-1, Section 8 is not addressed in detail. The characteristic load-carrying capacity of the connection at normal temperature is  $F_{v,Rk} = 80 \text{ kN}$  and its design load-carrying capacity is  $F_{v,Rd} = 49 \text{ kN}$  (with  $\gamma_M = 1,3$  and  $k_{mod} = 0,8$  for medium term action and service class 1). In the following the verification of the fire resistance of the connection is shown in term of strength  $R_{d,fi} \geq E_{d,fi}$  or in term of time  $t_{d,fi} \geq t_{req}$ .

### 6.2.2.2 Actions

As a simplification, EN 1995-1-2, Section 2, Eqn. 2.8 states that the effects of actions  $E_{d,fi}$  during fire exposure may be obtained from the analysis for normal temperature as:

$$E_{d,fi} = \eta_{fi} E_d \quad (6.3)$$

- $E_d$  design effect of actions for normal temperature design for the fundamental combination according to EN 1990
- $E_{d,fi}$  design effects of actions in the fire situation
- $\eta_{fi}$  reduction factor for the design load in the fire situation

As indicated in EN 1995-1-2, Section 2.4.2, the reduction factor  $\eta_{fi}$  can be assumed as  $\eta_{fi} = 0,6$ . Therefore, the design effect of actions during fire exposure is calculated as:

$$E_{d,fi} = \eta_{fi} E_d = 0,6 \cdot 40 = 24 \text{ kN}$$

### 6.2.2.3 Load-carrying capacity after a given fire exposure (strength verification)

The design load-carrying capacity of an unprotected connection with fasteners in shear, according to EN 1995-1-2, Eqn. 6.5 and Eqn. 6.6, should be calculated as:

$$F_{v,Rd,fi} = \eta F_{v,Rk} \frac{k_{fi}}{\gamma_{M,fi}} = e^{-k \cdot t_{d,fi}} F_{v,Rk} \frac{k_{fi}}{\gamma_{M,fi}} \quad (6.4)$$

- $F_{v,Rk}$  characteristic load-carrying capacity at normal temperature according to EN 1995-1-1
- $k$  parameter given in EN 1995-1-2, Table 6.3
- $t_{d,fi}$  design fire resistance (in minutes)
- $k_{fi}$  modification factor for fire, taking into account the 20% fractiles of strength properties of timber according to EN 1995-1-2, Section 2, Table 2.1
- $\gamma_{M,fi}$  partial safety factor for timber in fire (recommended value  $\gamma_{M,fi} = 1,0$ )

According to EN 1995-1-2, Table 6.3 the value of parameter  $k$  for steel-to-timber dowelled connections (with  $d \geq 12$  mm) and for fire exposures up to 30 minutes is  $k = 0,085$ . According to EN 1995-1-2, Table 2.1 for connections with fasteners in shear with side members of wood, the factor  $k_{fi}$  can be assumed as  $k_{fi} = 1,15$ .

The partial safety factor for timber in fire is  $\gamma_{M,fi} = 1,0$  (recommended value – further information may be found in the National Annex), the design fire resistance is  $t_{d,fi} = 30$  minutes and, finally, the characteristic load-carrying capacity of the connection at normal temperature is  $F_{v,Rk} = 80$  kN.

Thus, the load-carrying capacity of the connection after 30 minutes of fire exposure is calculated as:

$$F_{v,Rd,fi} = e^{-k \cdot t_{d,fi}} F_{v,Rk} \frac{k_{fi}}{\gamma_{M,fi}} = e^{-0,085 \cdot 30} \cdot 80 \cdot \frac{1,15}{1,0} = 7 \text{ kN}$$

The verification of the fire resistance of the connection in term of strength is therefore not satisfied:

$$E_{d,fi} = 24 \text{ kN} \leq F_{v,Rd,fi} = 7 \text{ kN} \quad \text{Not OK } \otimes$$

#### 6.2.2.4 Fire resistance for a given load level (time verification)

The design fire resistance of an unprotected connection loaded by the design effect of actions in the fire situation, according to EN 1995-1-2, Eqn. 6.7, should be calculated as:

$$t_{d,fi} = -\frac{1}{k} \ln \left( \eta_{fi} \eta_0 \frac{k_{mod} \gamma_{M,fi}}{\gamma_M k_{fi}} \right) \quad (6.5)$$

- $t_{d,fi}$  design fire resistance (in minutes)
- $k$  parameter given in EN 1995-1-2, Table 6.3
- $\eta_{fi}$  reduction factor for the design load in the fire situation
- $\eta_0$  degree of utilisation at normal temperature
- $\gamma_M$  partial safety factor for the connection according to EN 1995-1-1
- $k_{mod}$  modification factor according to EN 1995-1-1
- $k_{fi}$  modification factor for fire, taking into account the 20% fractiles of strength properties of timber according to EN 1995-1-2, Section 2, Table 2.1
- $\gamma_{M,fi}$  partial safety factor for timber in fire (recommended value  $\gamma_{M,fi} = 1,0$ )

According to EN 1995-1-2, Table 6.3 the value of parameter  $k$  for steel-to-timber dowelled connections (with  $d \geq 12$  mm) and for fire exposures up to 30 minutes is  $k = 0,085$ . According to EN 1995-1-2, Table 2.1 for connections with fasteners in shear with side members of wood, the factor  $k_{fi}$  can be assumed as  $k_{fi} = 1,15$ . The reduction factor  $\eta_{fi}$  for the design load in the fire situation is assumed to be  $\eta_{fi} = 0,6$  as indicated in EN 1995-1-2, Section 2.4.2.

The degree of utilisation at normal temperature can be calculated as:

$$\eta_0 = \frac{E_d}{R_d} = \frac{40 \text{ kN}}{49 \text{ kN}} = 0,82$$

- $E_d$  design effect of actions for normal temperature design for the fundamental combination according to EN 1990
- $R_d$  design load-carrying capacity of the connection at normal temperature (with  $\gamma_M = 1,3$  and  $k_{mod} = 0,8$  for medium term action and service Class 1).

Therefore, the design fire resistance of the connection can be calculated as:

$$t_{d,fi} = -\frac{1}{0,085} \ln \left( 0,6 \cdot 0,82 \cdot \frac{0,8}{1,3} \cdot \frac{1,0}{1,15} \right) = 15 \text{ min}$$

The verification of the fire resistance of the connection in term of time is therefore not satisfied:

$$t_{d,fi} = 15 \text{ min} \geq t_{req} = 30 \text{ min} \quad \text{Not OK } \otimes$$

#### 6.2.2.5 Fire resistance of protected connection

In order to increase the fire resistance and comply with the required fire resistance of 30 minutes, one layer of gypsum plasterboard type F is used to protect the connection.

According to EN 1995-1-2, Eqn.6.3, when the connection is protected by the addition of gypsum plasterboard type F, the time until start of charring should satisfy the following requirement:

$$t_{ch} \geq t_{req} - 1,2t_{d,fi} \quad (6.6)$$

$t_{ch}$  time until start of charring of the protected member  
 $t_{req}$  required fire resistance  
 $t_{d,fi}$  design fire resistance of the unprotected connection

For claddings consisting of one layer of gypsum plasterboard type F the time of start of charring  $t_{ch}$  (in minutes) of the protected member according to EN 1995-1-2, Eqn.3.11, can be calculated as:

$$t_{ch} = 2,8h_p - 14 \quad (6.7)$$

$h_p$  thickness of the panel, in mm

As the required standard fire resistance period is  $t_{req} = 30$  min. and the design fire resistance of the unprotected connection is  $t_{d,fi} = 15$  min. (obtained in the previous section), the minimum thickness of the protective gypsum plasterboard type F can be calculated as:

$$h_p \geq \frac{t_{req} - 1,2t_{d,fi} + 14}{2,8} = \frac{30 - 1,2 \cdot 15 + 14}{2,8} = 9,3 \text{ mm}$$

## 6.3 Fire design of separating timber assemblies

### 6.3.1 Basis of design

The main objective of structural fire safety measures is to restrict the spread of fire to the room of origin by guaranteeing the load-carrying capacity of the structure (Requirement on Mechanical Resistance R) and the separating function of walls and floors (Requirement on Insulation I and Integrity E) for the required period of time. Concerning the basic requirements for fire compartmentation, EN 1995-1-2 states:

“Where fire compartmentation is required, the elements forming the boundaries of the fire compartment shall be designed and constructed in such a way that they maintain their separating function during the relevant fire exposure. This shall include, when relevant, ensuring that:

- integrity failure does not occur (Criterion E),
- insulation failure does not occur (Criterion I), and
- thermal radiation from the unexposed side is limited.”

Criterion I (insulation) may be assumed to be satisfied where the average temperature rise over the whole of the non-exposed surface is limited to 140K, and the maximum temperature rise at any point on that surface does not exceed 180K (for fire exposure of the standard temperature-time curve), thus preventing ignition of objects in the neighbouring compartment. Criterion E (integrity) may be assumed to be satisfied when no sustained flaming or hot gases to ignite a cotton pad on the side of



the construction not exposed to fire occur, or no cracks or openings in excess of certain dimensions exist. There is no risk of fire spread due to thermal radiation when Criterion I (insulation) is satisfied.

Criterion I (insulation) is clearly defined, and so could be verified by heat transfer calculations instead of by testing if thermal material properties could be found as a function of temperature (conductivity and heat transfer). On the other hand, Criterion E (integrity) is mostly determined by testing, because calculations are still quite impossible (crack formation, dynamics of hot gases, etc.). For example, premature integrity failure may occur due to sudden failure of claddings or opening of gaps, which are often dependent on construction details such as fixings. However, extensive experience of full-scale testing of wall and floor assemblies made it possible to define some rules about detailing of wall and floor assemblies that have been included in EN 1995-1-2. Thus EN 1995-1-2 assumes that Criterion E (integrity) is satisfied where Criterion I (insulation) has been satisfied and panels remain fixed to the timber structure on the side not exposed to fire.

### 6.3.2 Simplified design method

In timber buildings, walls and floors are mostly built up by adding different layers to form an assembly. For the calculation of fire resistance with regard to the separation function of timber assemblies, component additive methods can be used. These methods are thus called because they determine the fire resistance of a layered construction by adding the contribution of the different layers to obtain the fire resistance. A review of calculation methods for verification of the separating performance of wall and floor assemblies as used in the United Kingdom, Canada and Sweden, as well as according to ENV 1995-1-2 is presented in (König et al., 2000). The Swedish component additive method builds upon that described in ENV 1995-1-2 and the Canadian method by taking into account the influence of adjacent materials on the fire performance of each layer, and therefore describes the real fire performance more accurately (Östman et al., 1994).

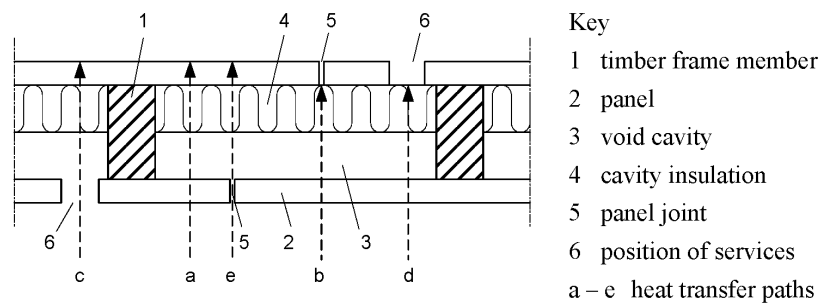
The analysis method for the separating function of wall and floor assemblies given in EN 1995-1-2, Annex E is informative; this means that the method shall be used according to the National Annex in the country concerned. The design method is based on modification of the Swedish component additive method by extending it to floors, including the effect of joints in claddings that are not backed by members, battens or panels, and applying some of the position coefficients to further test results that became available during the drafting of EN 1995-1-2. The design method is capable of considering claddings made of one or two layers of wood-based panels and gypsum plasterboard, and also voids or insulation-filled cavities. The insulation may be made of mineral wool.

EN 1995-1-2 requires verification that the time ( $t_{ins}$ ) that it takes for the temperature to increase (starting from room temperature) by 140K/180K on the side of the assembly that is not exposed to fire is equal to or greater than the required fire resistance period ( $t_{req}$ ) for the separating function of the assembly.

$$t_{ins} \geq t_{req} \quad (6.8)$$

The insulation time  $t_{ins}$  depends on the fire behaviour of the layers used in the assemblies, as well as the positions and joint configurations of the layers. For simplicity, the time  $t_{ins}$  can be calculated as the sum of the contributions of the individual layers to fire resistance, considering different heat transfer paths (see Figure 6.3.1).

$$t_{ins} = \sum_{i=1}^{i=n} t_{ins,i} \quad (6.9)$$



**Fig.6.3.1** Illustration of heat transfer paths through separating multiple-layered construction

These contributions depend firstly on the inherent insulation property of each layer, as given by the basic insulation value, and secondly on the position of the respective layer and the materials backing or preceding that layer (in the direction of the heat flux), as given by the position coefficient. Further, a joint coefficient is used in order to take into account the influence of joint configurations on the insulation time of layers with joints. Thus the contribution of each layer  $t_{ins,i}$  is calculated using the basic insulation value ( $t_{ins,0,i}$ ), the position coefficient ( $k_{pos,i}$ ) and the joint coefficient ( $k_{j,i}$ ).

$$t_{ins,i} = t_{ins,0,i} k_{pos,i} k_{j,i} \quad (6.10)$$

The basic insulation value corresponds to the contribution of a single layer to fire resistance without the influence of adjacent materials, and depends on the material and the thickness of the layer. EN 1995-1-2 gives equations for calculating the basic insulation values for the following materials:

Panels:

- Plywood ( $\rho \geq 450 \text{ kg/m}^3$ )
- Wood panelling ( $\rho \geq 400 \text{ kg/m}^3$ )
- Particleboard and fibreboard ( $\rho \geq 600 \text{ kg/m}^3$ )
- Gypsum plasterboard, types A, F, R and H

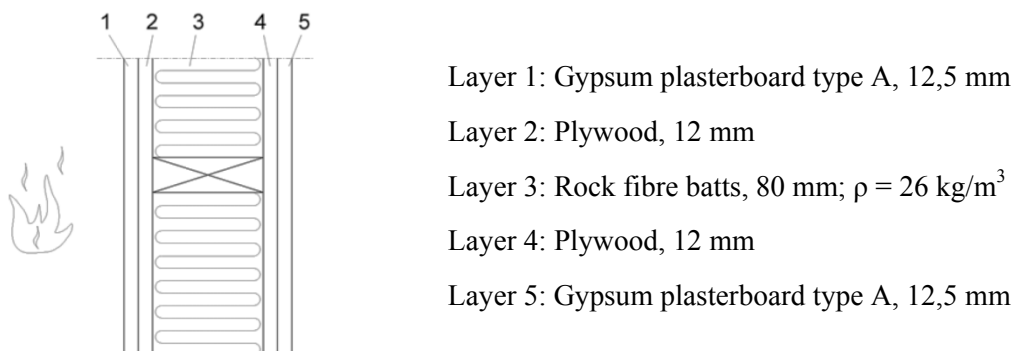
Cavity insulations:

- Stone wool ( $26 \text{ kg/m}^3 \leq \rho \leq 50 \text{ kg/m}^3$ )
- Glass wool ( $15 \text{ kg/m}^3 \leq \rho \leq 26 \text{ kg/m}^3$ )

The position coefficient considers the position of the layer within the assembly (in direction of the heat flux), because the layers preceding and backing the layer under consideration have an influence on its fire behaviour. EN 1995-1-2 gives tabulated data for position coefficients for wall and floor assemblies with claddings made of one or two layers of wood-based panels and gypsum plasterboards, and void or insulation-filled cavities. The position coefficients were determined based on testing of non-load bearing wall assemblies, both in full scale and in small scale. This means that the position coefficients that are given are limited to a small number of timber constructions. An improved design method for the verification of the separating function of timber assemblies can be found in (Östman et al., 2010).

### 6.3.3 Worked example

Figure 6.3.2 shows the construction of a light timber frame wall assembly. In the following the verification of the separating function of the wall assembly for 60 minutes fire resistance is shown.



**Fig.6.3.2** Construction of a light timber frame wall assembly

#### Calculation of the basic insulation values of the layers:

- Layer 1: Gypsum plasterboard type A, 12,5 mm

$$t_{ms,0,1} = 1,4h_p = 1,4 \cdot 12,5 = 17,5 \text{ min} \quad \text{according to EN 1995-1-2, Eqn. E.6}$$

- Layer 2: Plywood, 12 mm

$$t_{ms,0,2} = 0,95h_p = 0,95 \cdot 12 = 11 \text{ min} \quad \text{according to EN 1995-1-2, Eqn. E.3}$$

- Layer 3: Rock fibre batts, 80 mm;  $\rho = 26 \text{ kg/m}^3$

$$t_{ms,0,3} = 0,2h_{ins}k_{dens} = 0,2 \cdot 80 \cdot 1,0 = 16 \text{ min} \quad \text{according to EN 1995-1-2, Eqn. E.7}$$

- Layer 4: Plywood, 12 mm

$$t_{ms,0,4} = 0,95h_p = 0,95 \cdot 12 = 11 \text{ min} \quad \text{according to EN 1995-1-2, Eqn. E.3}$$

- Layer 5:

- Gypsum plasterboard type A, 12,5 mm

$$t_{ms,0,5} = 1,4h_p = 1,4 \cdot 12,5 = 17,5 \text{ min} \quad \text{according to EN 1995-1-2, Eqn. E.6}$$

**Table 6.3.1** Determination of the position coefficients according to EN 1995-1-2, Annex E, Table E5

Construction:		Layer number				
Layer number and material		1	2	3	4	5
1, 2, 4, 5 3	Wood-based panel Void	0,7	0,9	1,0	0,5	0,7
1, 2, 4, 5 3	Gypsum plasterboard type A or H Void	1,0	0,8	1,0	0,8	0,7
1, 5 2, 4 3	Gypsum plasterboard type A or H Wood-based panel Void	1,0	0,8	1,0	0,8	0,7
1, 5 2, 4 3	Wood-based panel Gypsum plasterboard type A or H Void	1,0	0,6	1,0	0,8	0,7
1, 2, 4, 5 3	Wood-based panel Rock fibre batts	0,7	0,6	1,0	1,0	1,5
1, 2, 4, 5 3	Gypsum plasterboard type A or H Rock fibre batts	1,0	0,6	1,0	0,9	1,5
1, 5 2, 4 3	Gypsum plasterboard type A or H Wood-based panel Rock fibre batts	1,0	0,8	1,0	1,0	1,2
1, 5 2, 4 3	Wood-based panel Gypsum plasterboard type A or H Rock fibre batts	1,0	0,6	1,0	1,0	1,5

- Layer 1:  $k_{pos,1} = 1,0$
- Layer 2:  $k_{pos,2} = 0,8$
- Layer 3:  $k_{pos,3} = 1,0$
- Layer 4:  $k_{pos,4} = 1,0$
- Layer 5:  $k_{pos,5} = 1,2$

Determination of the joint coefficients according to EN 1995-1-2, Annex E, Table E7

Layers 1 to 4:  $k_j = 1,0$  (layer backed by other layer)

Layer 5:  $k_j = 1,0$  (filled joints)

Verification of the separating function of the wall assembly for 60 minutes fire resistance:

$$t_{ins} = \sum_{i=1}^{i=5} t_{ins,i} = \sum_{i=1}^{i=5} (t_{ins,0,i} k_{pos,i} k_{j,i}) = 17,5 \cdot 1,0 + 11 \cdot 0,8 + 16 \cdot 1,0 + 11 \cdot 1,0 + 17,5 \cdot 1,2 = 74 \text{ min} \quad \Leftrightarrow \text{OK}$$

### References

- Buchanan, A.H. 2000. Fire performance of timber construction. Progress in Structural Engineering and Materials 2: 278–289.
- Dhima, D. 1999. Vérification expérimentale de la résistance au feu des assemblages d'éléments en bois. CTICM, Ref. INC 99/399 DD/NB.
- EN 338:2009: Structural timber - Strength classes. CEN.
- EN 520:2004+A1:2009: Gypsum plasterboards - Definitions, requirements and test methods. CEN.
- EN 1990:2002+A1:2005+A1:2005/AC:2010. Eurocode: Basis of structural design. CEN.
- EN 1991-1-2:2002+AC:2009. Eurocode 1: Actions on structures - Part 1-2: General actions - Actions on structures exposed to fire. CEN.
- EN 1995-1-1:2004+AC:2006+A1:2008. Eurocode 5: Design of timber structures - Part 1-1: General - Common rules and rules for buildings. CEN.
- EN 1995-1-2:2004+AC:2009. Eurocode 5: Design of timber structures - Part 1-2: General - Structural fire design. CEN.

- ENV 1995-1-2:1994. Eurocode 5: Design of timber structures, Part 1-2: General rules – Structural fire design. European Prestandard. CEN.
- EN 14080:2011. Timber structures - Glued laminated timber and glued solid timber – Requirements. CEN.
- Frangi, A., and M. Fontana. 2003. Charring rates and temperature profiles of wood sections. *Fire and Materials* 27: 91–102.
- Frangi, A., C. Erchinger and M. Fontana. 2008. Charring model for timber frame floor assemblies with void cavities. *Fire Safety Journal* 43: 551–564.
- Gerhards, CC. 1982. Effect of moisture content and temperature on the mechanical properties of wood: An analysis of immediate effects. *Wood and Fiber* 14: 4–36.
- Glos, P., and D. Henrici. 1990. Festigkeit von Bauholz bei hohen Temperaturen, Abschlussbericht 87505, Institut für Holzforschung der Universität München.
- Källsner, B., and J. König. 2000. Thermal and mechanical properties of timber and some other materials used in light timber frame construction. Proceedings of CIB W18, Meeting thirty-three, Delft, 2000.
- König, J., and L. Walleij. 1999. One-dimensional charring of timber exposed to standard and parametric fires in initially protected and non-protected fire situations. Trätektek – Swedish Institute for Wood Technology Research, Report No. I 9908029, Stockholm.
- König, J., T. Oksanen and K. A. Towler. 2000. Review of component additive methods used for the determination of fire resistance of separating light timber frame construction. Proceedings of CIB W18, Meeting thirty-three, Delft, 2000.
- König, J. 2000. Timber frame assemblies exposed to standard and parametric fires. Part 2: A design model for standard fire exposure. Trätektek, Swedish Institute for Wood Technology Research, Report I 0001001, Stockholm.
- König, J. 2005. Structural fire design according to Eurocode 5 - Design rules and their background. *Fire and Materials* 29: 147–163.
- Kruppa, J., T. Lamadon and P. Racher. 2000. Fire resistance tests of timber connections. CTICM, Ref. INC-00/187-JK/NB.
- Norén, J. 1996. Load-bearing capacity of nailed joints exposed to fire. *Fire and Materials* 20: 133–143.
- Östman, B., J. König and J. Norén. 1994. Contribution to fire resistance of timber frame assemblies by means of fire protective boards. Proceedings of the 3<sup>rd</sup> International Fire and Materials Conference, Washington D.C.
- Östman, B. et al. 2010. Fire safety in timber buildings - Technical guideline for Europe, SP-Report 2010:19, Stockholm.
- Schaffer, EL. 1967. Charring Rate of Selected Woods - Transverse to Grain. Forest Service Research Paper FPL 69. Forest Products Laboratory, Madison, WI.



Europe Direct is a service to help you find answers to your questions about the European Union  
Freephone number (\*): 00 800 6 7 8 9 10 11

(\*): Certain mobile telephone operators do not allow access to 00 800 numbers or these calls may be billed.

A great deal of additional information on the European Union is available on the Internet.  
It can be accessed through the Europa server <http://europa.eu>.

How to obtain EU publications

Our publications are available from EU Bookshop (<http://bookshop.europa.eu>),  
where you can place an order with the sales agent of your choice.

The Publications Office has a worldwide network of sales agents.  
You can obtain their contact details by sending a fax to (352) 29 29-42758.

European Commission

EUR 26698 EN – Joint Research Centre – Institute for the Protection and Security of the Citizen

Title: Eurocodes: background & applications. Structural Fire Design. Worked examples

Author(s): Olivier Vassart, Bin Zhao, Louis-Guy Cajot, Fabienne Robert, Udo Meyer, Andrea Frangi

Editors: Martin Poljanšek, Borislava Nikolova, Luis Sousa, Silvia Dimova, Artur Pinto

Luxembourg: Publications Office of the European Union

2014 – 252 pp. – 21.0 x 29.7 cm

EUR – Scientific and Technical Research series – ISSN 1831-9424

ISBN 978-92-79-38671-8 (PDF)

## JRC Mission

As the Commission's in-house science service, the Joint Research Centre's mission is to provide EU policies with independent, evidence-based scientific and technical support throughout the whole policy cycle.

Working in close cooperation with policy Directorates-General, the JRC addresses key societal challenges while stimulating innovation through developing new methods, tools and standards, and sharing its know-how with the Member States, the scientific community and international partners.

*Serving society*  
*Stimulating innovation*  
*Supporting legislation*

doi:10.2788/85432

ISBN 978-92-79-38671-8

