

JRC SCIENCE FOR POLICY REPORT

PROSPECT FOR NEW GUIDANCE IN THE DESIGN OF FRP

*Support to the implementation, harmonization
and further development of the Eurocodes*

Authors

Luigi Ascione, Jean-François Caron, Patrice Godonou,
Kees van IJselmuiden, Jan Knippers, Toby Mottram,
Matthias Oppe, Morten Gantriis Sorensen, Jon Taby,
Liesbeth Tromp

Editors

Luigi Ascione, Eugenio Gutierrez, Silvia Dimova,
Artur Pinto, Steve Denton

2016



European Commission
Joint Research Centre
Institute for the Protection and the Security of the Citizen

Contact information

Silvia Dimova

Address: Joint Research Centre, Via Enrico Fermi 2749, TP 480, 21027 Ispra (VA), Italy

E-mail: silvia.dimova@jrc.ec.europa.eu

Tel.: +39 0332 78 9063

This publication is a Science and Policy Report by the Joint Research Centre, the European Commission's in-house science service. It aims to provide evidence-based scientific support to the European policy-making process. The scientific output expressed does not imply a policy position of the European Commission. Neither the European Commission nor any person acting on behalf of the Commission is responsible for the use which might be made of this publication.

JRC Science Hub

<https://ec.europa.eu/jrc>

JRC99714

EUR 27666 EN

PDF	ISBN 978-92-79-54225-1	ISSN 1831-9424	doi:10.2788/22306	LB-NA-27666-EN-N
Print	ISBN 978-92-79-54226-8	ISSN 1018-5593	doi:10.2788/851558	LB-NA-27666-EN-C

© European Union, 2016

Reproduction is authorised provided the source is acknowledged.

Printed in Italy

How to cite: L. Ascione, J.-F. Caron, P. Godonou, K. van IJselmuiden, J. Knippers, T. Mottram, M. Oppe, M. Gantriis Sorensen, J. Taby, L. Tromp; Prospect for new guidance in the design of FRP; EUR 27666 EN; doi:10.2788/22306

All images © Luigi Ascione

Abstract

Over the last twenty years, many innovative solutions have confirmed the usefulness of composite structures realized with FRPs (Fibre Reinforced Polymer or Plastic). The need of European standards for use of fibre-reinforced polymer composites in civil engineering was justified in 2007 in the JRC Report EUR 22864 EN. The new European technical rules will be developed using the existing organization of CEN/TC250.

The present report has been worked out in the frame of CEN/TC250/WG4 activities. The report encompasses:

- Part I, which introduces the policy framework and the CEN/TC250 initiative
- Part II, which gives a prospect for CEN guidance for the design and verification of composite structures realized with FRPs

The report presents scientific and technical background intended to stimulate debate and serves as a basis for further work to achieve a harmonized European view on the design and verification of such structures. This has been the main impulse to include the work item of the Fibre Reinforced Polymer Structures in the Mandate M/515 with high priority.

FOREWORD

The **construction sector** is of strategic importance to the EU as it delivers the buildings and infrastructure needed by the rest of the economy and society. It represents more than **10% of EU GDP and more than 50% of fixed capital formation**. It is the largest single economic activity and it is the biggest industrial employer in Europe. The sector employs directly almost 20 million people. Construction is a key element not only for the implementation of the **Single Market**, but also for other construction relevant EU Policies, e.g. **Sustainability, Environment and Energy**, since 40-45% of Europe's energy consumption stems from buildings with a further 5-10% being used in processing and transport of construction products and components.

The **EN Eurocodes** are a set of **European standards** which provide common rules for the design of construction works, to check their strength and stability against extreme live loads such as fire and earthquakes. In line with the EU's strategy for smart, sustainable and inclusive growth (EU2020), **Standardisation** plays an important part in supporting the industrial policy for the globalization era. The improvement of the competition in EU markets through the adoption of the Eurocodes is recognized in the "Strategy for the sustainable competitiveness of the construction sector and its enterprises" - COM (2012)433, and they are distinguished as a tool for accelerating the process of convergence of different national and regional regulatory approaches.

With the publication of all the 58 Eurocodes Parts in 2007, the implementation in the European countries started in 2010 and now the process of their adoption internationally is gaining momentum. The Commission Recommendation of 11 December 2003 stresses the importance of training in the use of the Eurocodes, especially in engineering schools and as part of continuous professional development courses for engineers and technicians, which should be promoted both at national and international level. It is recommended to undertake research to facilitate the integration into the Eurocodes of the latest developments in scientific and technological knowledge.

In May 2010 **DG GROW issued the Programming Mandate M/466 EN to CEN concerning the future work on the Structural Eurocodes**. The purpose of the Mandate was to initiate the process of further evolution of the Eurocode system. M/466 requested CEN to provide a programme for standardisation covering:

- Development of **new standards or new parts** of existing standards, e.g. a new construction material and corresponding design methods or a new calculation procedure;
- Incorporation of **new performance requirements and design methods** to achieve further harmonisation of the implementation of the existing standards.

Following the answer of CEN, in December 2012 DG GROW issued the Mandate M/515 EN for detailed work programme for amending existing Eurocodes and extending the scope of structural Eurocodes. In May 2013 CEN replied to M/515 EN. Over 1000 experts from across Europe have been involved in the development and review of the document. The CEN/TC250 work programme encompasses all the requirements of M/515 EN, supplemented by requirements established through extensive consultation with industry and other stakeholders. The set-up of the Project Teams on the work programme is in a final stage and the publishing of the complete set of new standards is expected by 2020.

The standardisation work programme of CEN/TC250 envisages that the new pre-normative documents will first be published as JRC Science and Policy Reports, before their publication as CEN Technical Specifications. After a period for trial use and commenting, CEN/TC 250 will decide whether the Technical Specifications should be converted into ENs.

Over the last twenty years, many innovative solutions have confirmed the usefulness of composite structures realized with FRPs (Fibre Reinforced Polymer or Plastic). The need of European standards for use

of fibre-reinforced polymer composites in civil engineering was justified in 2007 in the JRC Report EUR 22864 EN.

This pre-normative document is published as a part of the JRC Report Series “Support to the implementation, harmonization and further development of the Eurocodes” and presents preliminary proposals relating to **Prospect for New Guidance in the Design of Composite Structures Realized with FRP (Fibre Reinforced Polymer or Plastic) Materials. It was developed by CEN/TC250 Working Group (WG) 4 on Fibre Reinforced Polymer Structures.** This JRC Science and Policy Report presents scientific and technical background intended to stimulate debate and serves as a basis for further work to achieve a harmonized European view on the design and verification of composite structures realized with FRPs. This has been the main impulse to include the work item of the Fibre Reinforced Polymer Structures in the Mandate M/515 with high priority.

The report is subdivided into two parts:

- Part I, which introduces the policy framework and the CEN/TC250 initiative
- Part II, which gives a prospect for CEN guidance for the design and verification of composite structures realized with FRPs

The editors and authors have sought to present useful and consistent information in this report. However, users of information contained in this report must satisfy themselves of its suitability for the purpose for which they intend to use it.

The report is available to download from the “Eurocodes: Building the future” website (<http://eurocodes.jrc.ec.europa.eu>).

Ispra, January 2016

Artur Pinto, Eugenio Gutierrez, and Silvia Dimova

*European Laboratory for Structural Assessment (ELSA)
Institute for the Protection and Security of the Citizen (IPSC), Joint Research Centre (JRC)*

Luigi Ascione

Convenor of CEN/TC250/WG4 on Fibre Reinforced Polymer Structures

Steve Denton

Parsons Brinckerhoff, Chairman of CEN/TC250

REPORT SERIES “SUPPORT TO THE IMPLEMENTATION, HARMONIZATION AND FURTHER DEVELOPMENT OF THE EUROCODES”

In the light of the Commission Recommendation of 11 December 2003, DG JRC is collaborating with DG ENTR and CEN/TC250 “Structural Eurocodes”, and is publishing the Report Series “**Support to the implementation, harmonization and further development of the Eurocodes**” as JRC Science and Policy Reports. This Report Series includes, at present, the following types of reports:

1. **Policy support documents**, resulting from the work of the JRC in cooperation with partners and stakeholders on “Support to the implementation, promotion and further development of the Eurocodes and other standards for the building sector”;
2. **Technical documents**, facilitating the implementation and use of the Eurocodes and containing information and practical examples (Worked Examples) on the use of the Eurocodes and covering the design of structures or its parts (e.g. the technical reports containing the practical examples presented in the workshop on the Eurocodes with worked examples organized by the JRC);
3. **Pre-normative documents**, resulting from the works of the CEN/TC250 and containing background information and/or first draft of proposed normative parts. These documents can be then converted to CEN Technical Specifications;
4. **Background documents**, providing approved background information on current Eurocode part. The publication of the document is at the request of the relevant CEN/TC250 Sub-Committee;
5. **Scientific/Technical information documents**, containing additional, non-contradictory information on current Eurocode part, which may facilitate its implementation and use, or preliminary results from pre-normative work and other studies, which may be used in future revisions and further developments of the standards. The authors are various stakeholders involved in Eurocodes process and the publication of these documents is authorized by relevant CEN/TC250 Sub-Committee or Working Group.

Editorial work for this Report Series is **performed by the JRC** together with partners and stakeholders, when appropriate. The publication of the reports type 3, 4 and 5 is made after approval for publication by CEN/TC250, or the relevant Sub-Committee or Working Group.

The publication of these reports by the JRC serves the purpose of implementation, further harmonization and development of the Eurocodes. However, it is noted that neither the Commission nor CEN are obliged to follow or endorse any recommendation or result included in these reports in the European legislation or standardisation processes.

The reports are available to download from the “Eurocodes: Building the future” website (<http://eurocodes.jrc.ec.europa.eu>).

ACKNOWLEDGEMENTS

This report has been prepared for the development of a future European guidance for the design and verification of composite structures realized with FRPs under the aegis of CEN/TC250. CEN/TC250 acknowledges the substantial contribution of the many international experts of CEN/TC250/WG4 and others, who have supported the works by their essential input and reviews, notably:

- Eugenio Gutierrez who chaired the European Working Group convened by the JRC ELSA Unit in 2006-2007 and was the main contributor to the JRC Report EUR 22864 EN “Purpose and justification for new design standards regarding the use of fibre-reinforced polymer composites in civil engineering”.
- *Convenors of Task Groups:* Luigi Ascione, Jean-François Caron, Miroslav Cerny, João Ramôa Correia, Patrice Godonou, Kees van IJselmuiden, Jan Knippers, Toby Mottram, Matthias Oppe, Wendel Sebastian, Morten Gantriis Sorensen, Ioannis Stefanou, Jon Taby, Liesbeth Tromp, Frédéric Waimer.
- *Representatives of National Authorities and Standardisation Bodies:* Keely Andrews, Heiki Aasmann, Etienne Cailleau, Patrice Godonou, Marianne Goor, Tomas Jirak, Mark Lurvink, Thomas Nolan, Suzanne Peters, Andreas Schleifer.

Luigi Ascione

Convenor of CEN/TC250/WG4 on Fibre Reinforced Polymer Structures

Reference to the front pictures:

Hybrid GFRP-steel bridge across highway A27, Utrecht, The Netherlands

Solar charging station, Joué les Tours, France.

S. Maria Paganica Church, L’Aquila, Italy.

CONTENTS

PART I: POLICY FRAMEWORK

1 Purpose, justification and benefits	13
1.1 Introduction	13
1.2 Trends in the construction sector.....	13
1.3 Need for European Guidelines	14
2 Examples of composite structures in Europe	15
3 CEN/TC250 initiative/Mandate 515	27
3.1 Background and justification of the work with priority	27
3.2 Interface to the EN Eurocodes for structural design.....	30
4 Approach to execution of the Mandate	31
4.1 Step-by-step development	31
4.2 Organization of the work.....	31
4.2.1 Liaisons within CEN/TC250 family	31

PART II: PROSPECT FOR CEN GUIDANCE

1 GENERAL	39
1.1 SUBJECT AND SCOPE	39
1.2 NORMATIVE REFERENCES	39
1.3 GUIDELINES.....	41
1.4 ASSUMPTIONS	42
1.5 TERMS AND DEFINITION.....	43
1.5.1 TERMS RELATING TO FIBRE-REINFORCED POLYMER	43
1.5.2 ABBREVIATIONS.....	45
1.6 SYMBOLS.....	46
1.7 AGREEMENTS ON AXES ORIENTATIONS.....	49
2 BASIS OF DESIGN	51
2.1 BASIC REQUIREMENTS.....	51
2.2 DURABILITY	52
2.3 VERIFICATION BY THE PARTIAL FACTORS METHOD	53
2.3.1 LOAD EFFECTS CALCULATION	54
2.3.1.1 LOAD EFFECTS DUE TO ERECTION OR INSTALLATION	54
2.3.1.2 THERMAL LOAD EFFECTS.....	54
2.3.1.3 PRESTRESSES.....	54
2.3.2 DESIGN VALUES OF THE PROPERTIES OF MATERIALS, ELEMENTS AND PRODUCTS.....	54
2.3.3 DESIGN CAPACITY	55
2.3.4 MATERIAL PARTIAL FACTORS	56

2.3.4.1	FRP LAMINATES AND STRUCTURES	56
2.3.4.2	JOINTS	57
2.3.5	APPROACH TO SPECIAL PROBLEMS BY USING CONVERSION FACTORS	57
2.3.6	RELEVANT CONVERSION FACTORS	58
2.3.6.1	TEMPERATURE	58
2.3.6.2	HUMIDITY	59
2.3.6.3	CREEP	59
2.3.6.4	FATIGUE	61
2.3.6.5	ADHESIVE JOINTS.....	62
2.4	REQUIREMENTS FOR FASTENERS	62
2.5	REFERENCES.....	62
3	MATERIALS.....	65
3.1	GENERAL.....	65
3.1.1	FIBRES, RESINS, ADHESIVE, PLY AND LAMINATE PROPERTIES	66
3.1.2	FRP BEAM ELEMENTS	67
3.1.3	SANDWICH: CORES AND PANELS.....	67
3.2	DURABILITY TESTS	67
3.3	REFERENCES.....	69
4	DURABILITY	71
4.1	GENERAL.....	71
4.2	MEASURES FOR SPECIFIC ENVIRONMENTAL CONDITIONS	72
4.2.1	UV RADIATION	72
4.2.2	THERMAL MATERIAL EFFECTS	72
4.2.3	HUMIDITY, WATER AND CHEMICALS	73
4.2.4	STATIC CHARGE	74
4.2.5	FIRE	74
5	BASIS OF STRUCTURAL DESIGN	77
5.1	ANALYSIS CRITERIA	77
5.2	VERIFICATION CRITERIA.....	77
5.3	STRAIN EVALUATION	78
5.4	BEHAVIOUR IN THE CASE OF FIRE	78
5.5	DESIGN ASSISTED BY TESTING	78
5.6	REFERENCES.....	78
6	ULTIMATE LIMIT STATES.....	81
6.1	GENERAL.....	81

6.2	ULTIMATE LIMIT STATES OF PROFILES	81
6.2.1	NORMAL FORCE.....	81
6.2.1.1	AXIAL TENSION	81
6.2.1.2	AXIAL COMPRESSION.....	82
6.2.2	FLEXURE.....	83
6.2.2.1	IN-PLANE FLEXURE.....	83
6.2.2.2	COMBINATION OF BENDING AND AXIAL TENSILE FORCE	84
6.2.2.3	COMBINATION OF BENDING AND AXIAL COMPRESSION FORCE	85
6.2.3	SHEAR	85
6.2.4	TORSION	87
6.2.5	BENDING AND SHEAR.....	88
6.3	ULTIMATE LIMIT STATES OF LAMINATED PLATES AND SHELLS	88
6.3.1	RESISTANCE VERIFICATIONS.....	88
6.3.1.1	PLY LEVEL.....	88
6.3.1.2	LAMINATE LEVEL.....	89
6.3.2	STABILITY VERIFICATIONS.....	89
6.4	ULTIMATE LIMIT STATES OF SANDWICH PANELS.....	89
6.4.1	FACING FAILURE	90
6.4.2	TRANSVERSE SHEAR FAILURE	91
6.4.3	FLEXURAL CRUSHING OF THE CORE	92
6.4.4	LOCAL CRUSHING OF THE CORE	92
6.4.5	Global BUCKLING	93
6.4.6	SHEAR CRIMPING.....	95
6.4.7	FACE WRINKLING	96
6.4.8	INTRACELL BUCKLING	96
6.5	FATIGUE.....	97
6.5.1	GENERAL.....	97
6.5.2	FATIGUE RESISTANCE	98
6.5.2.1	MIXED-MODE FATIGUE LIFE PREDICTION	99
6.5.2.2	COMPONENT FATIGUE TESTING FOR COMPLEX MIXED MODE EFFECTS.....	100
6.6	REFERENCES.....	100
7	SERVICEABILITY LIMIT STATES	105
7.1	GENERAL.....	105
7.2	DEFORMATIONS	105
7.2.1	DEFORMATION UNDER FREQUENT LOADS	105

7.2.2	DEFORMATION UNDER INCIDENTAL LOADS	105
7.2.3	DEFORMATION UNDER QUASI-PERMANENT LOADS	106
7.3	VIBRATION AND COMFORT	106
7.3.1	VIBRATION	106
7.3.2	COMFORT	106
7.4	DAMAGE	106
7.5	REFERENCES.....	106
8	CONNECTIONS.....	109
8.1	GENERAL.....	109
8.2	DESIGN CRITERIA	109
8.3	BOLTED JOINTS	110
8.3.1	GENERAL	110
8.3.2	DESIGN CRITERIA	112
8.3.3	BOLTED JOINTS SUBJECTED TO IN PLANE ACTIONS	113
8.3.3.1	NET-TENSION FAILURE	114
8.3.3.2	PIN-BEARING FAILURE	114
8.3.3.3	SHEAR-OUT FAILURE.....	115
8.3.3.4	BOLT-SHEAR FAILURE	116
8.3.4	BOLTED JOINTS SUBJECTED TO OUT OF PLANE ACTIONS	116
8.3.4.1	PULL-OUT FAILURE	116
8.3.4.2	BOLT FAILURE FROM TENSILE FORCES	116
8.3.5	BOLTED JOINTS SUBJECTED TO IN AND OUT OF PLANE ACTIONS.....	117
8.3.6	REFERENCES.....	117
8.4	ADHESIVE BONDED JOINTS.....	118
8.4.1	GENERAL	118
8.4.2	CONSTITUTIVE LAWS OF THE INTERFACE.....	119
8.4.3	INTERFACE FAILURE	120
8.4.3.1	FAILURE DUE TO DEBONDING OF THE JOINT	120
8.4.3.2	FAILURE DUE TO DEBONDING AND OPENING OF THE JOINT.....	120
8.4.4	ULTIMATE LIMIT STATE OF THE JOINT	121
8.4.5	PRACTICAL DESIGN REGULATIONS	121
8.4.6	BONDING CONTROL	122
8.4.6.1	DESTRUCTIVE TESTS.....	122
8.4.6.2	NONDESTRUCTIVE TESTS.....	122
8.4.7	REFERENCES.....	122

9	PRODUCTION, REALIZATION, MANAGEMENT AND MAINTENANCE	123
9.1	GENERAL.....	123
9.2	QUALITY PLAN	123
9.3	MATERIALS	124
9.4	PRODUCTION	124
9.4.1	GEOMETRIC TOLERANCES, IMPERFECTIONS AND DEVIATIONS IN FIBRE ALIGNMENT.....	125
9.4.2	CONNECTIONS	125
9.5	HANDLING AND STORAGE	126
9.6	INSTALLATION.....	126
9.7	USE.....	127
9.8	MAINTENANCE, INSPECTION AND REPAIR.....	127
9.8.1	MAINTENANCE	127
9.8.2	INSPECTION	128
9.8.3	REPAIRS.....	128
10	ANNEX A (CONVERSION FACTOR $\eta_{cv,20}$).....	131
10.1	REFERENCES.....	133
11	ANNEX B (INDICATIVE VALUES OF FIBRES, RESINS, PLY AND LAMINATE PROPERTIES)	135
11.1	GENERAL.....	135
11.2	FIBRES	135
11.2.1	GENERAL.....	135
11.3	RESIN.....	136
11.3.1	GENERAL.....	136
11.3.2	THERMOSET RESINS.....	136
11.4	FILLERS AND ADDITIVES.....	137
11.5	CORE MATERIALS.....	137
11.6	PLY PROPERTIES.....	138
11.6.1	GENERAL.....	138
11.6.2	INDICATIVE VALUES FOR PLY STIFFNESS PROPERTIES.....	139
11.6.2.1	UD PLYS.....	139
11.6.2.2	BI-DIRECTIONAL PLYS	140
11.6.2.3	MAT PLY.....	141
11.6.3	INDICATIVE VALUES FOR PLY STRENGTH PROPERTIES.....	142
11.6.4	LINEAR COEFFICIENT OF EXPANSION FOR PLYS	142
11.6.5	COEFFICIENT OF THERMAL CONDUCTIVITY FOR PLYS	144
11.6.6	SWELLING OF PLYS.....	145

11.7	LAMINATE PROPERTIES	145
11.7.1	GENERAL	145
11.7.2	STIFFNESS AND STRENGTH	146
11.7.2.1	INTERLAMINAR SHEAR STRENGTH OF LAMINATES (ILSS)	146
11.7.3	THERMAL EXPANSION FOR LAMINATES	147
11.7.4	COEFFICIENT OF THERMAL CONDUCTIVITY FOR LAMINATES	147
11.7.5	SWELLING OF LAMINATE	147
11.7.6	MATERIAL PROPERTIES FOR FATIGUE ANALYSIS	147
11.8	REFERENCES	148
12	ANNEX C (VALUES OF $N_{c,Rd2}$ FOR DOUBLE SYMMETRIC PROFILES)	149
12.1	REFERENCES	151
13	ANNEX D (VALUES OF M_{Rd2} FOR DOUBLE SYMMETRIC PROFILES)	153
13.1	REFERENCES	156
14	ANNEX E (LOCAL INSTABILITY OF THE WEB PANEL)	157
14.1	References	160
15	ANNEX F (INSTABILITY OF ORTHOTROPIC SYMMETRICAL PLATES)	161
15.1	GENERAL	161
15.2	ANALYTICAL SOLUTIONS FOR FLAT PLATES	161
15.2.1	GENERAL	161
15.2.2	PLATES IN COMPRESSION	161
15.2.3	SHEAR FORCE	162
15.2.4	PURE BENDING LOAD	163
15.2.5	COMBINED LOADS	163
15.3	REFERENCES	164
16	ANNEX G (SIMPLIFIED CONSTITUTIVE INTERFACE LAWS)	167
16.1	REFERENCES	168
17	ANNEX H (FATIGUE TESTING)	169
17.1	DEFINING AN S-N DIAGRAM BY TESTING	169
17.2	CLD DIAGRAMS	170
17.3	REFERENCES	171

PROSPECT FOR NEW GUIDANCE IN THE DESIGN OF FRP STRUCTURES

PART I: POLICY FRAMEWORK

1 PURPOSE, JUSTIFICATION AND BENEFITS

1.1 INTRODUCTION

CEN/TC250 has taken the initiative to prepare a document addressing the purpose and justification for new European technical rules and associated standards for the design and verification of composite structures realized with FRPs (Fibre Reinforced Polymer or Plastic). CEN/TC250 formed a CEN Working Group WG4 to further develop the work item. The Working Group, after about three years of activity and many meetings, drew up a first proposal of Scientific Technical Report. The successive update drafts have been presented and discussed on the occasion of the meetings of CEN/TC250.

The CEN/TC250 initiative was motivated by the expanding and extensive construction of new structures entirely made with FRPs. The corresponding market is becoming more and more important in Europe during the last two decades.

The analysis of the present situation in the construction sector and the identification of the design concepts provided by the current structural design codes and trends in the construction market are the bases for the perspective of the future generation of codes for the design and verification of such structures.

The initiative of CEN/TC250 also follows the action exerted by JRC and in particular by Eugenio Gutierrez, Silvia Dimova and Artur Pinto who published in 2007 the JRC Report entitled *“Purpose and justification for new design standards regarding the use of fibre-reinforced polymer composites in civil engineering”* [01].

1.2 TRENDS IN THE CONSTRUCTION SECTOR

Over the last twenty years, several innovative solutions have confirmed the usefulness of composite structures realized with FRPs (Fibre Reinforced Polymers or Plastics), both within and outside Europe. The main types of FRP in consideration here are GFRP (Glass Fibre Reinforced Polymers) and CFRP (Carbon Fibre Reinforced Polymers). These solutions are often imposed by specific needs such as the requirement for speed of assembly on site or the necessity for an enhanced resistance to aggressive environments, which in turn reduces overall and maintenance costs. In addition, the lightweight of the FRP composite makes the assembly and the launch of the structure easier, besides offering a geotechnical advantage for all structures that have to rest on deformable soils. The superior strength to weight ratio of FRP thus allows for a greater load bearing capacity, when compared to conventional building materials.

Within this context, the use of FRP profiles, shell structures and sandwich panels is particularly advantageous for applications in the Civil Engineering field. FRP bearing structures are therefore widely used for the construction of buildings for industrial or residential purposes. FRP usage is also increasingly widespread for civil engineering works and ranges from lock gates, to entire bridges or bridge decks both for pedestrian and vehicular traffic.

In addition to the advantages listed above, other main benefits associated with the use of FRP in buildings and civil engineering works are:

- Better opportunities for prefabrication;
- Reduced traffic downtime during assembly and launch of the structure;
- Reduced risks for accidents associated with onsite work;
- Reduced manpower costs associated with onsite work;
- Competitive prices over the structure's live cycle;
- High quality of the finished structure;
- Great freedom in architectural shape;
- Superior suitability for the enlargement of existing bridges;
- Great adaptability for a wide range of accessory solutions such as railing systems, walkways, inspection parapets, roof panels, balconies, façade cladding, viaduct and bridge edge elements;
- Easier transportation of structural components to areas of difficult access, e.g. those hit by natural disasters.

The most frequently used FRP manufacturing techniques for buildings and civil engineering works are pultrusion and vacuum assisted resin infusion also called Vacuum Assisted Resin Transfer Moulding (VARTM). Other common manufacturing processes are prepregging, hand lay-up, filament winding and compression moulding.

An idea of the market volume that revolves around the FRPs in Europe can be deduced from the following data relative to the latest five-year period: the total annual production for GFRP (Glass Fibre Reinforced Polymer) only was about 1 Million tons, of which 35% was for the civil construction field.

1.3 NEED FOR EUROPEAN GUIDELINES

Because of their steadily increasing market volume and given the complexity of FRP structures, it became obvious that it is necessary to develop a standardization document for both the production of FRP structural elements and the practical rules for the design and verification of structures to be used for buildings and civil engineering works.

Several countries have contributed to the development of currently available guidelines, among which it may be appropriate to mention the following ones:

<i>EUROCOMP</i>	<i>Structural Design of Polymer Composites (Design Code and Handbook, Finland, France, Sweden, UK, 1996);</i>
<i>CUR 96</i>	<i>Fibre Reinforced Polymers in Civil Load Bearing Structures (Dutch Recommendation, 2003);</i>
<i>BD90/05</i>	<i>Design of FRP Bridges and Highway Structures (The Highways Agency, Scottish Executive, Welsh Assembly Government, the Department for Regional Development Northern Ireland, May 2005);</i>

<i>DIBt</i>	<i>DIBt – Medienliste 40 für Behälter, Auffangvorrichtungen und Rohre aus Kunststoff, Berlin (Germany, May 2005);</i>
<i>CNR-DT 205/2007</i>	<i>Guide for the Design and Construction of Structures made of Pultruded FRP elements (Italian National Research Council, October 2008);</i>
<i>ACMA</i>	<i>Pre-Standard for Load and Resistance Factor Design of Pultruded Fiber Polymer Structures (American Composites Manufacturer Association, November 2010);</i>
<i>DIN 13121</i>	<i>Structural Polymer Components for Building and Construction (Germany, August 2010);</i>
<i>BÜV</i>	<i>Tragende Kunststoff Bauteile im Bauwesen [TKB] – Richtlinie für Entwurf, Bemessung und Konstruktion (Germany, 2010).</i>

The increasing number of structural FRP applications has led to a growing interest from researchers around the world, with a profusion of international conferences and scientific contributions as a result. These activities address both mechanical modelling and testing of numerical models, as well as studies on laboratory samples and real scale prototypes. In addition, numerous international journals are now specifically dedicated to work discussing FRP composite materials and structures used in building and civil engineering works.

The experience so far gained through the realization of FRP composite structures in many European and non-European countries, as well as the theoretical and experimental understanding gained in this field makes it possible today to develop a single set of guidelines aimed for the EC countries. These guidelines may compile a body of rules based on the considerable scientific and technological progress achieved by member countries in this field, to be applied to the design and execution of FRP composite structures.

2 EXAMPLES OF COMPOSITE STRUCTURES IN EUROPE

Some relevant examples of civil engineering structures, realized (or under realization) in Europe with the use of FRPs, are given below as an illustration of the widespread use of this kind of structures and of the growing interest for them.

• Realizations in Denmark



Kolding, Denmark. Pedestrian and cycle bridge from 100% pultruded GFRP profiles. The bridge is 40 m long and 3.2 m wide. Its total weight is 120 kN. The load capacity is 5 kN/m². The bridge was inspected after 15 years' service life and no damage was found. Contractor: Fiberline Composites A/S, Middelfart, Denmark, 1997.



Nørre Aaby, Denmark. Construction of a pedestrian and cycle bridge with 100% pultruded Glass FRP (GFRP) profiles. The bridge is 23 m long and was built to replace an existing Reinforced Concrete (RC) bridge, damaged from usage and corrosion. It weighs only 60 kN compared to around 1200 kN for a RC bridge. Consequently, it was possible to reuse the existing foundation. The bridge was installed in just two hours, thus avoiding disruption to traffic. Contractor: Fiberline Composites A/S, Middelfart, Denmark. 2007.



Copenhagen, Denmark. Renovation of a sewage plant with 1200 m² pultruded GFRP coverings. The sewage plant is one of the biggest in Northern Europe and chose GFRP due to high durability requirements. Contractor: Fiberline Composites A/S, Middelfart, Denmark. 2008.



Svendborg, Denmark. Construction of a pedestrian and cycle bridge with pultruded GFRP Deck. The bridge is 40 m long and 3.2 m wide. The bridge was installed in just two hours, thus avoiding disruption to traffic. Contractor: Fiberline Composites A/S, Middelfart, Denmark, 2009.



Karrebæksminde, Denmark. Renovation of a bascule road bridge where a pultruded GFRP deck was installed on the old steel structure, and a pedestrian and cycle bridge from 100% pultruded GFRP profile was hung on the side to increase capacity. It is the first Danish road bridge made with a composite deck. It replaces a wooden deck that had to be replaced/renovated about every 5 years. The installation of the bridge was performed at night to minimize the interruption of the traffic, and it was completed within a few hours. Contractor: Fiberline Composites A/S, Middelfart, Denmark, 2011.



Copenhagen, Denmark. Renovation of a metro tunnel with pultruded phenolic GFRP gratings. The gratings were part of an upgrade of the emergency exits, and were made in phenolic resin in order to achieve the specified fire rating "B". Contractor: Fiberline Composites A/S, Middelfart, Denmark, 2012.



Esbjerg, Denmark. Pedestrian and cycle bridge with pultruded GFRP deck. The bridge is constructed with steel beams adhesively bonded to the GFRP deck. It is 18 m long and 3 m wide. Contractor: Fiberline Composites A/S, Middelfart, Denmark, 2012.

- **Realizations in France**



Joué les Tours, France. Solar charging station (SUDI™). Structure made to more than 80 % of its weight in composite (GFRP specific pultruded profiles and low pressure moulding parts). It supports 40 m² of solar panel. Contractor: SOLUTIONS COMPOSITES, Mettray (37), France.



Plessis Robinson (92) France. Helipad made with pultruded GFRP profiles. A very efficient solution in terms of fire protection, weight and quick installation. Contractor: TH Composites, France.



Ephemeral cathedral of Creteil, France. Realization of a GFRP gridshell, made with pultruded tubes. Gridshells offer an important freedom of shape for the designer. The covered surface is 350 m². 1775 m of pultruded tubes were used. The weight of the structure is 5 kg/m². Design: Navier laboratory. Contractor: Structural engineering company T.E.S.S., 2014.

- **Realizations in Germany**



Klipphausen (Dresden), Germany. It is the first road bridge built from 100 % GFRP pultruded beams and deck in Germany. Contractor: Fiberline Composites A/S, Middelfart, Denmark, 2002.

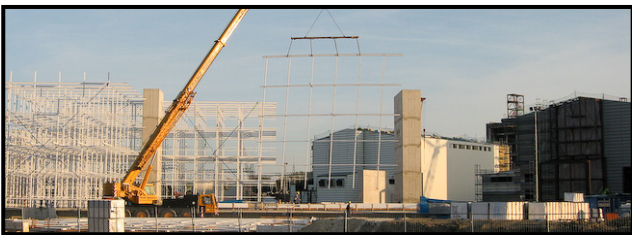

Hamm Uentrop, Germany. Construction of a 100% GFRP cooling tower as a beam-column system made from more than 100t of pultruded structural profiles. Contractor: Fiberline Composites A/S, Middelfart, Denmark, 2005.



Neumünster, Germany. 100% GFRP cooling tower as a beam-column system made from more than 40t of pultruded structural profiles. Contractor: Fiberline Composites A/S, Middelfart, Denmark, 2008.



Friedberg Bridge, Germany. Motorway bridge under construction. The bridge, along 27.0 m and width 5.0 m, consists of two steel beams covered by an innovative multi-cell platform made of Fiberline's "FBD 600" GFRP profiles. The precast composite structural profiles were glued in-situ on the two steel beams. Contractor: Fiberline Composites A/S, Middelfart, Denmark, 2008.



Reinbek, Hamburg, Germany. Construction of a pedestrian bridge (Holländerbrücke). The bridge was made of steel beams and a GFRP pultruded deck. 100 m long and 3.5 m wide, it crosses the busy Hamburgerstraße. The modules of the bridge were built in a factory and then transported by road to Reinbek where they were placed in position on the foundations. Contractor: Fiberline Composites A/S, Middelfart, Denmark. 2009.



Mittelsburen, Germany. 100% GFRP cooling tower as a beam-column system made from more than 120t of pultruded structural profiles. Contractor: Fiberline Composites A/S, Middelfart, Denmark, 2013.

- **Realizations in Iceland**



Hellisheidi, Iceland. 100% GFRP cooling tower as a beam-column system made from more than 100t of pultruded structural profiles. Contractor: Fiberline Composites A/S, Middelfart, Denmark, 2008.

- **Realizations in Italy**



Archaeological area of Pitigliano, Grosseto (Italy). Construction of a pedestrian bridge. Span 27.0 m. GFRP pultruded profiles. Contractor: ECT System, Castelfidardo, Ancona, 2004.



S. Maria Paganica Church, L'Aquila (Italy). Replacing the roof of the church damaged by the earthquake of April 2009. GFRP pultruded members. Designers: prof. Salvatore Russo, ing. Alessandro Adilardi. Contractor: Top Glass S.p.A, Osnago (LC), 2010.



Salerno (Italy). Pedestrian bridge at the University of Salerno. Length: 148 m; main span: 37 m. GFRP pultruded I-beam. The deck is made of GFRP sandwich panels. Designer: prof. Luciano Feo, 2014 (In construction).

- **Realizations in Netherlands**



'Bronlibelle' Bridge in Harderwijk, the Netherlands. A 6.3 m wide, 22 m long GFRP bicycle / footbridge connecting two new districts of Harderwijk. At the same time unlocking an efficient route for heavy emergency vehicles (e.g. firetrucks). The bridge deck is made by applying the vacuum infusion technology, thus providing excellent properties with desired freedom for design. The bridge is designed according to CUR96, EN 1990 and EN 1991. Architectural and preliminary design by Royal HaskoningDHV. Engineering, production and installation by Delft Infra Composites B.V.



Spieringsluis, Werkendam, the Netherlands. First FRP lock-gate in the Netherlands, installed in Werkendam. Total width of the lock is 6 m. Dimensions of each panel: width 3.5 m, height 6.5 m. Has been developed on request from Rijkswaterstaat through the SMOZ-committee. Produced by Polymarin in cooperation with DSM (resins), PPG (glass fibre reinforcement) and Bekaert (pultruded profiles), 2000.



Lock gates, ETA Lock KW28, canal Erica – Ter Apel, Emmen, (The Netherlands)

Four doors, per gate: height 5.0 m, length 3.5 m, thickness 122 mm, specific weight of the doors 1000 kg/m³. Produced by VARTM.

Designed and produced as flexible, thin flat doors, slightly curved to resist creep deformations. These doors support 2.6 m water height difference. Engineered according the CUR96 and the Eurocodes EN 1990 and EN 1991. Engineered, produced and installed by FiberCore Europe, 2012.



Floriadebrug, Venlo (The Netherlands). Bicycle /pedestrian bridge with steel beams covered with a GFRP pultruded deck (BIJL plank 500 mm x 55 mm). The bridge is 127.5 m long and 6 m wide and has been designed to carry vehicles up to 12t weight. Contractor: Aa-Dee, Schijndel, the Netherlands and manufacturer of composite deck materials Bijl Profielen B.V., Heijningen, The Netherlands, 2012.



Slender canopy with dimensions 43 m x 12 m (column every 10 m). Installed at the DSM Chemelot Campus in Geleen (The Netherlands). Calculated according the CUR96 and the Eurocodes EN 1990 and EN 1991. Construction made in Fibre Reinforced Polymer sandwich and steel HE-M profiles. Produced and installed by Poly Products, 2009.



Hybrid GFRP-steel bridge across highway A27, Utrecht (The Netherlands). Traffic bridge. Length 142 m (2 spans of 71 m), width 6.5 m. Made with VARTM injections, (11 tons of resin in one shot). Composite deck spans the width of the bridge, carrying Eurocode traffic loads and all horizontal loads of the bridge, including collision loads (Calculated according the CUR96 and the Eurocodes EN 1990 and EN 1991) The GRP-steel joint is both bolted and glued. Ducts for rainwater and electric cables are integrated. Engineered, produced and installed by FiberCore Europe, 2013.



Sint Sebastiaansbridge, Delft (The Netherlands). Bridge designed according to CUR96, EN 1990 and EN 1991. Main girders in steel. Vacuum infused GFRP sandwich structure with adhesive and bolted connections to steel members. Table lift bridge for vehicle loads (LM1) and tram. Moveable deck: span 34 m, width 12 m. Engineered by Royal HaskoningDHV. Design and tender stage, not yet in production, 2013-2014.



62 park bridges, Rotterdam, (The Netherlands). A family of park bridges, Eurocode pedestrian/bicycle loading, with lengths ranging from 6.6 to 17.3 m and widths ranging from 1.5 to 4.5 m. GRP sandwich structure InfraCore Inside deck made with VARTM. Faceted undersides. Engineered according the CUR96 and the Eurocodes EN 1990 and EN 1991. Engineered, produced and installed by FiberCore Europe 2013 (32 bridges), 2014-2015 (34 bridges).

- **Realizations in Portugal**

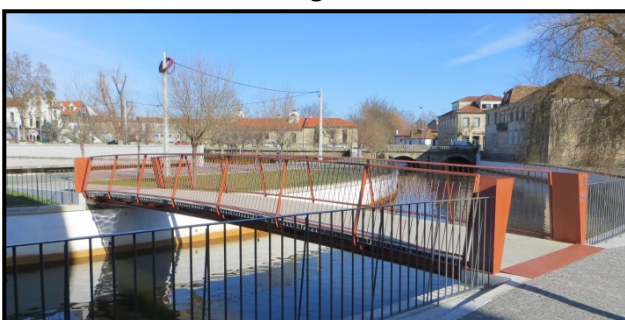

S. Mateus Bridge, Viseu. Pedestrian hybrid footbridge with a span of 13.3 m and 2 m of width. Made of two steel girders bonded to a multi-cellular GFRP pultruded deck with panel-to-panel snap-fit connections. Designer: Mário Sá, Portugal, 2013.

- Realizations in Russia



Train station Kosino, Chertanovo in Moscow. The pedestrian bridge is 41.4 m long by 3 m wide and it is made with FRP structural profiles joined by bolting. It consists of three spans - two of 15 m and one of 13 m length – prefabricated and assembled on site. The bridge was installed in just 49 minutes. The job lasted a total of about three hours and was carried out on Sunday morning to avoid rail traffic interruption. Contractor: Fiberline Composites A/S, Middelfart, Denmark, 2004.



P. Vernadskogo subway station, Moscow, Russia. Arched walkway realized with FRP profiles moulded by infusion. The bridge is the first one made of composite moulded by vacuum infusion. This technology offers the possibility of eliminating the processes of assembly and decreases the manpower costs. Length: 22.6 m; width: 2.8 m; weight: 55 kN. Contractor: Lightweight Structures BV, Delft, The Netherlands, 2008.



Salavat, Russia. 100% GFRP cooling tower as a beam-column system made from more than 100t of pultruded structural profiles. Contractor: Fiberline Composites A/S, Middelfart, Denmark, 2007.



Moscow, Russia. Deck of a pedestrian bridge with GFRP pultruded profiles. Length: 79.5 m; width: 3.7 m. Contractor: APATECH, Russia, 2010.

- **Realizations in Spain**



Railway crossing over the high speed line Madrid-Barcelona, near Lleida city (Spain). Pedestrian walkway with GFRP profiles. The footbridge is 3 m wide and 38 m long. Contractor: Fiberline Composites A/S, Middelfart, Denmark, 2004.



Cueva de-Arrikruz Oñati, Spain. A pedestrian walkway with GFRP profiles and grids was built inside the cave. The bridge, 400 m long, takes visitors to a depth of 55 m. This solution is ideal to prevent degradation due to strongly corrosive moisture in the atmosphere. At the same time, the resistance of the profiles provides a sturdy non-slip decking, while preserving the beauty of the cave. Contractor: Fiberline Composites A/S, Middelfart, Denmark, 2007.

- **Realizations in United Kingdom**



Golf Club in Aberfeldy (Scozia). The length of the cable-stayed pedestrian bridge is 113 m long and has a main span of 63 m. The two piers and the deck are made with GFRP, while the stays are made of aramid fibre cables. The only parts that are not in composite are the foundations that are made of reinforced concrete, and the steel connection between the stays and the pedestrian walkway, 1992.



Oxfordshire, UK. First road bridge for a public highway made from 100% GFRP and CFRP pultruded profiles. The bridge was inspected after 12 years' service life and no damage to the GFRP and CFRP was found. Contractor: Fiberline Composites A/S, Middelfart, Denmark, 2002.



Motorway M6, Lancashire, UK. Road bridge over a motorway. The bridge is 52 m long and has been designed to carry vehicles up to 400 kN weight. GFRP pultruded profiles "FBD 600 ASSET". Contractor: Fiberline Composites A/S, Middelfart, Danmark, 2006.



Greater Manchester, UK. The 13 m wide, 9 m long Moss Canal traffic bridge comprises pultruded GFRP double-web beams (DWBs) laid on their sides to act as both a cellular deck and the main longitudinal beams. The fibre type was changed from carbon in the standard DWB to glass for this specific application. This deck was proof-tested under 10 million cycles of local wheel load fatigue at the University of Bristol, supervised by Dr Wendel Sebastian. The DWB deck arrangement weighs 40% of the original deteriorated concrete deck, so the original bridge abutments and foundations were re-used. Designer - SKM Ltd. Main contractor - Askam Construction Ltd. Supplier - Pipex Ltd / Strongwell, 2012.

- Realizations in Switzerland



Ponteresina, Switzerland. Footbridge in 2 spans of 12.5 m for temporary use in the winter (designer: prof. T. Keller). GFRP profiles. Contractor: Fiberline Composites A/S, Middelfart, Denmark, 1997.



Münchensteinerstrasse, Basilea. Eyecatcher building made of GFRP pultruded beam. The building consists of 5 floors with a total of 15 m of height; the surface amounts to 120 m². Contractor: Fiberline Composites A/S, Middelfart, Denmark, 1999.



Novartis Campus Entrance Building, Switzerland. Lightweight GFRP cell-core sandwich roof on load-bearing glass envelop. Dimensions 21.6 m x 18.5 m. Designer: prof. T. Keller, 2006.

3 CEN/TC250 INITIATIVE/MANDATE 515

3.1 BACKGROUND AND JUSTIFICATION OF THE WORK WITH PRIORITY

The CEN/TC250 initiative is motivated by the lack of an applicable set of European-wide technical rules to deal with the enormously expanding construction activities in designing and verifying composite structures realized with FRPs.

The availability of Guidelines for the building and construction sector will facilitate the free movement of FRP materials and the activities of consulting or contracting companies within the European Community. This field offers all the prospects for a progressive expansion, with substantial positive impacts of economic nature. Such a development would undoubtedly be favoured by the existence of a body of shared rules able to ensure a uniform level of quality and safety in the production and the use of FRP structures.

The broad interest in the development of a European-wide harmonised and acknowledged coherent set of technical specifications (TS) or Eurocode parts for the design and verification of composite structures realized with FRPs is demonstrated by the impressive number of 56 highly motivated members in CEN/TC250/WG4 bringing in their specific expertise.

Official members			
	Name	E-mail	Nominated by
1	Luigi Ascione (Convenor)	l.ascione@unisa.it l.ascione@tiscalinet.it	UNI, Italy
2	Heiki Aasmann	heiki@evs.ee	EVS, Estonia
3	Keely Andrews	keely.andrews@bsigroup.com	BSI, United Kingdom
4	Lone Døjbak Andersen	lda@fiberline.com	DS, Denmark
5	Andrea Benedetti	andrea.benedetti@unibo.it	UNI, Italy
6	Etienne Cailleau	etienne.cailleau@afnor.org	AFNOR, France
7	Jean-François Caron	caron@enpc.fr	AFNOR, France
8	Miroslav Cerny	cerny@hpro.klok.cvut.cz	UNMZ, Czeck republic
9	João Ramôa Correia	joao.ramoa.correia@ist.utl.pt	IPQ, Portugal
10	Wouter De Corte	wouter.decorte@ugent.be	NBN, Ghent University
11	Steve Denton	dentons@pbworld.com	BSI, United Kingdom
12	Asky Desta	asky.desta@bsigroup.com	BSI, United Kingdom
13	Emmanuel Ferrier	emmanuel.ferrier@univ-lyon1.fr	AFNOR, France

14	Patrice Godonou	patrice.godonou@angstrom.uu.se	SIS, Sweden
15	Marianne Goor	mg@ds.dk	DS, Denmark
16	Eugenio Gutierrez	eugenio.gutierrez@jrc.it	JRC, Italy
17	Reza Hagani	reza.haghani@chalmers.se	SIS, Chalmers University of Technology, Sweden
18	Ivonne Hagman	ivonne.hagman@nen.nl	NEN, the Netherlands
19	Rolph Holthuijsen	rolph.holthuijsen@nen.nl	NEN, the Netherlands
20	Marketa Jindrakova	cen.imp@cni.cz	UNMZ, Czech Republic
21	Tomas Jirak	jirak.tomas@unmz.cz	UNMZ, Czech Republic
22	Wojciech Karwowski	w.karwowski.pw.edu.pl	WKN, Poland
23	Ijselmuijden, Kees van	kees.van.ijselmuijden@rhdhv.com	NEN, the Netherlands
24	Jan Knippers	j.knippers@itke.uni-stuttgart.de	DIN, Germany
25	Fragoulis Krokos	fdk@elot.gr	ELOT, Greece
26	Aiva Kukule	aiva.kukule@lvs.lv	LVS, Latvia
27	Francois Landon	francois.landon@afnor.org	AFNOR, France
28	Robert Lignowski	cen.ccm@pkn.pl	PKN, Poland
29	Mark Lurvink	mark.lurvink@nen.nl	NEN, the Netherlands
30	Toby Mottram	toby.mottram@warwick.ac.uk	BSI, UK
31	Sten Nielsen	sten@ds.dk	DS, Denmark
32	Thomas Nolan	thomas.nolan@nsai.ie	NSAI, Ireland
33	Matthias Oppe	mo@khing.de	DIN, Germany
34	Huseyin Ozturk	usm@tse.org.tr	TSE, Turkey
35	Carlo Paulotto	carlo.paulotto@acciona.es	Acciona, Spain
36	Leonids Pakrastins	leonids.pakrastins@rtu.lv	LVS, Latvia
37	Pawel Poneta	p.poneta@mostostal.waw.pl pawelponeta@gmail.com	Mostostal Warszawa S.A., Poland
38	Andreas Schleifer	andreas.schleifer@din.de	DIN, Germany
39	Wendel Sebastian	wendel.sebastian@bristol.ac.uk	University of Bristol, UK
40	Jeanne Sirks	jeanne.sirks@nen.nl	NEN, the Netherlands

41	Ioannis Stefanou	ioannis.stefanou@enpc.fr	AFNOR, France
42	Jon Taby	jon.taby@fireco.no	SN, Norway
43	Thanasis Triantafillou	ttriant@upatras.gr	ELOT, Greece
44	Liesbeth Tromp	liesbeth.tromp@rhdhv.com	Royal HaskoningDHV, The Netherlands
45	Duska Vargovic	duska.vargovic1@hzn.hr	HZN, Croatia
46	Frédéric Waimer	f.waimer@itke.uni-stuttgart.de	University of Stuttgart, Germany
47	Tracey Wilkins	tracey.wilkins@bsigroup.com	BSI, United Kingdom
48	Roko Zarnic	roko.zarnic@fgg.uni-lj.si	SIST, Slovenia

The following experts have also contributed as observers

1	Francis P. Farrugia	francis.p.farrugia@mccaa.org.mt	Standards and Metrology Institute, Malta
2	Luciano Feo	l.feo@unisa.it	University of Salerno, Italy
3	André Madarasz	madarasz@nbn.be	NBN, Belgium
4	Suzanne Peters	suzanne.peters@nen.nl	NEN, the Netherlands
5	Martin Poljanšek	martin.poljansek@jrc.ec.europa.eu	JRC, EU
6	Salvatore Russo	salvatore.russo@iuav.it	University of Venice, Italy
7	Jeanne Sirks	jeanne.sirks@nen.nl	NEN, the Netherlands
8	Morten Gantriis Sorensen	mgs@fiberline.com	DS, Denmark

3.2 INTERFACE TO THE EN EUROCODES FOR STRUCTURAL DESIGN

The proposed new European technical rules for Fibre Reinforced Polymer Structures are related to the principles and fundamental requirements of the EN Eurocodes.

Thus, the technical rules for such structures are not self-standing rules but they complement rules of the relevant EN Eurocodes (Figure 1.1) by identifying and distinguishing the differences between the design of new structures made with FRPs and that realized with traditional materials.

It is recommended that the part interfacing EN 1991 for actions on structures agrees with the principles and application rules set within this Eurocode.

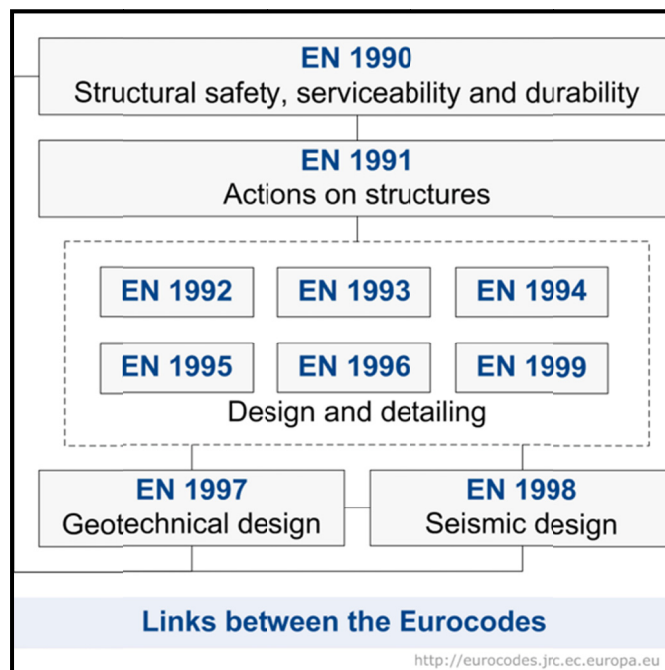

Figure 1.1 - Links between Eurocodes.

4 APPROACH TO EXECUTION OF THE MANDATE

4.1 STEP-BY-STEP DEVELOPMENT

The works of the future generation of Eurocodes will be performed in several steps:

- Step 1: Preparation and publication of a “Science and Policy Report”, subject to agreement of CEN/TC250.
- Step 2: After agreement of CEN/TC250, preparation and publication of CEN Technical Specifications (previously known as ENV).
- Step 3: After a period for trial use and commenting, CEN/TC250 will decide whether the CEN Technical Specifications should be converted into Eurocode Parts.

As a conclusion, the procedure in several steps does not predetermine to draft immediately new Eurocodes or new Eurocode Parts. In fact the procedure allows for a progressive development, agreed by CEN/TC250, in order to take into account observations from national experts and users.

The production of Science and Policy Reports is declared as pre-normative work and as such will not be funded under Mandate M/515.

The preparation of the new European technical rules in step 2 could be initiated by CEN/TC250 after launching the Mandate M/515.

4.2 ORGANIZATION OF THE WORK

4.2.1 LIAISONS WITHIN CEN/TC250 FAMILY

In document [02] CEN/TC250 replies to the Mandate M/515 setting a detailed work programme together with additional supporting information. In this context the new European technical rules for the design and verification of composite structures realized with FRPs will be developed using the existing organization of CEN/TC250 [03] (Figure 1.2).

The works are initiated and carried out by the Working Group WG4 “Fibre Reinforced Polymers” and supervised by CEN/TC250. The Working Group WG4 will develop general rules for the design and the verification of composite structures realized with FRPs.

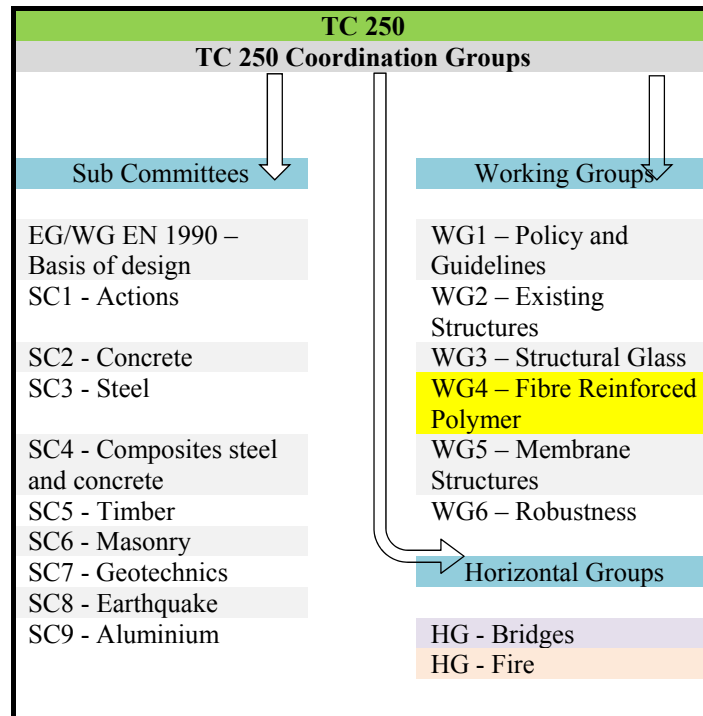

Figure 1.2 - Diagram showing the CEN/TC250 structure.

The main task of CEN/TC250/WG4 is not to undertake research work. In fact CEN/TC250/WG4 will be in close contact with scientific organisations. In consequence CEN/TC250 is responsible for implementation of results of research in codes of practice.

In particular with regard to the new European technical rules for the design and verification of composite structures realized with FRPs, the following organizations as stakeholders will be involved and consulted:

- National Standardisation Bodies;
- CEN Committees for construction products, construction materials, execution and testing;
- Government organizations involved in Building and Construction Regulations, and trade relating to construction;
- Professional Bodies (e.g. National and European Associations representing Consulting Engineers, Designers and Contractors);
- International Scientific and Technical Organisations (e.g. fib, ECCS, JCSS, IABSE, etc.);
- EOTA;
- Certification bodies;
- Producers of construction products and materials who rely on existing structures for their structural parameters;

- and others.

References

[01] JRC Scientific and Technical Report (EUR 22864 EN): *“Purpose and justification for new design standards regarding the use of fibre-reinforced polymer composites in civil engineering”* by E. Gutierrez, S. Dimova, and A. Pinto, 2007.

[02] European Commission Mandate M/515 EN *“Mandate for amending existing Eurocodes and extending the scope of structural Eurocodes”*, 2012.

[03] Document CEN/TC250-N993: Response to Mandate M/515, 2013.

PROSPECT FOR NEW GUIDANCE IN THE DESIGN OF FRP STRUCTURES

PART II: PROSPECT FOR CEN GUIDANCE

Preamble

This Part II presents scientific and technical proposals intended to serve as a starting point for further work to achieve a harmonized European view on the design and verification of composite structures realized with FRPs. Its fundamental purpose is to stimulate debate. To enable this objective to be fulfilled, it contains preliminary proposals for technical provisions and identifies key issues requiring further discussion. It is emphasised, however, that it is not intended for use in practice at this stage.

It is proposed that new European technical rules for such structures are related to the principles and fundamental requirements of the EN Eurocodes. Thus, technical rules for FRP structures would not be self-standing rules but rather they will complement rules of the relevant EN Eurocodes.

New European technical rules for the design and verification of composite structures realized with FRPs are planned for all types of buildings, bridges, and construction works exposed to all kind of actions.

CEN/TC250 policy, as set out in resolutions 254 and 255, is that the work for all new Parts of the Eurocodes, including the new European technical rules for FRP new structures follows a step-by-step approach, as follows:

1. Step: Preparation and publication of a JRC “Science and Policy Report” (S&P report), subject to agreement of CEN/TC250.
2. Step: After agreement of CEN/TC250, preparation and publication of CEN Technical Specifications (previously known as ENV).
3. Step: After a period for trial use and commenting, CEN/TC250 will decide whether the CEN Technical Specifications should be converted into Eurocode Parts.

The stepwise procedure allows for a progressive development in order to consider observations from national experts and users and to take into account comments received by CEN members.

It should be noted that the initial purpose of the “Science and Policy Report” was widened complying with CEN/TC250 decision 340 by adding an overview of the state of the art and a collation of existing national regulations and standards for the design and verification of composite structures realized with FRPs.

The structure of Part II represents the actual result of the preliminary but deep discussions in Working Group WG4. They should be considered as guidance for the evaluation of a harmonized approach in the frame of the decision making process in step 2.

In that respect the present draft provides the bases for the further development of new European technical rules for the design and verification of composite structures realized with FRPs and for the conversion into the format of CEN Technical Specifications. Therefore, as explained above, the actual draft of Part II is not yet intended for direct application and use in practice. It should rather stimulate the debate within CEN/TC250 and serve as a starting point for step 2.

Key issues

In particular it should be noted that the Working Group WG4 has recorded key issues that could require further discussion in the next steps.

In this context the following key issues have been identified:

1. The technical rules for FRP structures are not intended to be independent (self-standing) rules but to complement the existing rules of the relevant EN Eurocodes;
2. Appropriate calibration of the partial and conversion factors;
3. Effects of the fire;
4. Ultimate Limit States of sandwich structures;
5. Ultimate Limit States of laminates plates;
6. Predictive formulae for bolted joints in laminated plates;
7. Use and limits of bonded joints;
8. Effects of fatigue.

The key issues will be further discussed and resolved in step 2 while preparing the CEN Technical Specifications. For this reason one of the main purposes of the commenting phase is to seek views with regard to these key issues. In this context it should be emphasized that some of the key issues include aspects, which finally are to be determined on national level.

1 GENERAL

1.1 SUBJECT AND SCOPE

- (1) The goal of this scientific and technical report is to stimulate the debate about future guidelines and rules for the structural design and calculation of Fibre Reinforced Polymers (FRP) used in load-bearing structures, for buildings and civil engineering works.
- (2) The topics taken into account address the thermoset FRP parts with a fibre volume percentage of at least 15 %.
- (3) The report applies to FRP structures made of (i) profiles, (ii) plates and shells or (iii) sandwich panels.
- (4) Structures in which micro-cracks are not permissible fall outside the scope of this report.
- (5) The report does not include reinforcing rods, cables or external reinforcement to existing structures using FRP.
- (6) The structural elements taken into account are realized by means of the following main manufacturing processes: prepregging, pultrusion, compression moulding, resin transfer moulding, filament winding and hand lay-up. Sandwich structures, consisting of a core (foam, wood or honeycomb) covered by FRP face sheets, are also included.

1.2 NORMATIVE REFERENCES

EN 1997:2011	Geotechnical design - Part 1: General rules
EN-ISO 62:1999	Plastics. Determination of water absorption
EN-ISO 75-1:2012	Plastics - Determination of temperature of deflection under load - Part 1: General test method
EN-ISO 75-2:2012	Plastics - Determination of temperature of deflection under load - Part 2: Plastics and ebonite
EN-ISO 75-3:2004	Plastics - Determination of temperature of deflection under load - Part 3: High-strength thermosetting laminates and long fibre reinforced plastics
EN-ISO 178:1997	Plastics. Determination of flexural properties
EN-ISO 527-4:1997	Plastics. Determination of tensile properties. Part 4: Test conditions for isotropic and orthotropic fibre-reinforced plastic composites
EN-ISO 527-5:1997	Plastics. Determination of tensile properties. Part 5: Test conditions for unidirectional fibre-reinforced plastic composites
EN-ISO 604:1997	Plastics. Determination of compressive properties

EN-ISO 1172:1998	Textile glass reinforced plastics. Prepregs, moulding compounds and laminates - Determination of the textile-glass and mineral-filler content - Calcination methods
EN 1990:2002	Eurocode 0: Basis of structural design, including national annexes
EN 1997-1:2005	Eurocode 7: Geotechnical design – Part 1: General rules, including national annexes
EN 05/01/1991:2003	Eurocode 1: Actions on structures – Part 1-5: General actions – Thermal actions
EN 1991-1-6:2005	Eurocode 1: Actions on structures – Part 1-6: General actions – Actions during execution
EN 6721-11:2012	Plastics – Determination of dynamic mechanical properties – Part 11: Glass transition temperature
EN 13706-1:2002	Reinforced Plastic composites- Specification for pultruded profiles - Part 1: Designation
EN 13706-2:2002	Reinforced Plastic composites- Specification for pultruded profiles - Part 2: Methods of Test and General Requirements
EN 13706-3:2002	Reinforced Plastic composites- specification for pultruded profiles - Part 3: Specification requirements
EN 13121-1:2003	GRP tanks and vessels for use above ground - Part 1: Raw materials - Specification conditions and acceptance conditions
EN 13121-2:2003	GRP tanks and vessels for use above ground - Part 2: Composite materials - Chemical resistance
EN 13121-3:2008	GRP tanks and vessels for use above ground - Part 3: Design and workmanship
EN 13121-4:2005	GRP tanks and vessels for use above ground - Part 4: Delivery, installation and maintenance
EN-ISO 14125:1998	Fibre-reinforced plastic composites. Determination of flexural properties
EN-ISO 14126:1999	Fibre-reinforced plastics. Determination of compressive properties in the in-plane direction
EN-ISO 14129:1997	Fibre-reinforced plastic composites. Determination of the in-plane shear stress/shear strain response, including the in-plane shear modulus and strength, by the $\pm 45^\circ$ tension test method

EN-ISO 14130:1997	Fibre-reinforced plastic composites. Determination of apparent interlaminar shear strength by short-beam method
EN 16245: 2013	Fibre-reinforced plastic composites – Part 1-5: Declaration of raw material characteristics
ASTM D 695:2010	Standard Test Method for Compressive Properties of Rigid Plastics
ASTM D 790:2010	Standard Test Method for Flexural Properties of Unreinforced and Reinforced Plastics and Electrical insulating Materials
ASTM D 792:2008	Standard Test Method for Density and Specific Gravity (Relative Density) of Plastics by Displacement
ASTM D 2344:2006	Standard Test Method for Short Beam Strength of Polymer Matrix Composite Materials and their Laminates
ASTM D 2990:2009	Standard Test Methods for Tensile, Compressive, and Flexural Creep and Creep-Rupture of Plastics
ASTM D 3039:2008	Standard Test Method for Tensile Properties of Polymer Matrix Composite Materials
ASTM D 3410: 2008	Standard Test Method for Compressive Properties of Polymer Matrix Composite Materials with Unsupported Gage Section by Shear Loading
ASTM D 3518:2007	Standard Test Method for in-Plane Shear Response of Polymer Matrix Composite Materials by Tensile Test of a $\pm 45^\circ$ Laminate
ASTM D 4255:2007	Standard Test Method for in-Plane Shear Properties of Polymer Matrix Composite Materials by the Rail Shear Method

Specific standards relative to the sandwich panels are reported in §3.1.3, while specific standards relative to durability tests are reported in §3.2.

1.3 GUIDELINES

CUR 96	Fibre Reinforced Polymers in Civil Load Bearing Structures (Dutch Recommendation, 2003);
EUROCOMP	Structural Design of Polymer Composites (Design Code and Handbook, 1996);
BD90/05	Design of FRP Bridges and Highway Structures (The Highways Agency, Scottish Executive, Welsh Assembly Government, the Department for Regional Development Northern Ireland, May 2005);
DIBt	DIBt – Medienliste 40 für Behälter, Auffangvorrichtungen und Rohre aus Kunststoff, Berlin (In German, May 2005);

CNR-DT 205/2007	Guide for the Design and Construction of Structures made of Pultruded FRP elements (Italian National Research Council, October 2008);
ACMA	Pre-Standard for Load and Resistance Factor Design of Pultruded Fiber Polymer Structures (American Composites Manufacturer Association, November 2010);
DIN 13121	Structural Polymer Components for Building and Construction (August 2010);
BÜV	Tragende Kunststoffbauteile im Bauwesen [TKB] – Richtlinie für Entwurf, Bemessung und Konstruktion (in German, 2014).

1.4 ASSUMPTIONS

(1) Designs and calculations are considered to fulfil the requirements stated in this scientific and technical report on condition that:

- the selection of the structural system, the design and calculation of the structure is carried out by suitably qualified and experienced personnel;
- the production of material and structural parts, and construction on site are undertaken by personnel with the right professional skills and experience;
- proper supervision and quality control take place while the work is carried out, for example at the design and engineering firm, during the production of materials and parts, when assembling the materials and parts in factory or workshop, on construction site, etc.;
- the materials are used as described in this report or else equivalent relevant product or processing standards, normative requirements, and/or product specifications are followed;
- the manufacturing process for materials and parts fulfils the appropriate European product and process standards, to the extent not otherwise specified in this report. If no product and process standard is available, the designer, manufacturer and contractor should guarantee the required reliability of materials and structural properties through quality assurance measures. It should be shown that material and structural properties and geometrical tolerances satisfy at least the values specified in the design;
- the structure is properly maintained in accordance with maintenance instructions;
- the structure will be used in accordance with the design and calculation assumptions.

(2) FRP materials have a temperature-dependent behaviour due to the polymeric nature of their matrix. The following temperature ranges are considered for service conditions:

- normal temperature: from -20°C to $+40^{\circ}\text{C}$;
- elevated temperature: up to the maximum service temperature (dependent on the T_{gr} , see §3.1(11)).

1.5 TERMS AND DEFINITION

Anisotropic: non-isotropic; non-uniform mechanical and/or physical properties in different directions.

Characteristic value: value having a prescribed probability of not being attained in a hypothetical unlimited test series. This value generally corresponds to a specified fractile of the assumed statistical distribution of the particular property under examination.

Conversion factor η : a conversion factor shall be applied where it is necessary to convert the test results into values which can be assumed to represent the behaviour of the material or product in the structure or the ground.

Design working life: assumed period for which a structure or part of it is to be used for its intended purpose with anticipated maintenance but without major repair being necessary.

Fatigue: phenomenon which consists in the reduction of the material strength or product resistance resulting from the effects of repeated actions.

Isotropic: having uniform properties in all directions.

Limit states: states beyond which the structure no longer fulfils the relevant design criteria.

Load: any cause of stresses or deformations in a structure.

Partial load factors: numerical values for partial load factors are recommended as basic values that provide an acceptable level of reliability about the loads.

Partial material factors: numerical values for partial material factors are recommended as basic values that provide an acceptable level of reliability about the properties of materials and products.

Nominal value: value fixed on non-statistical bases, for instance on acquired experience or on physical conditions.

Orthotropic: a situation involving two or three axes of symmetry.

Serviceability limit states: states that correspond to conditions beyond which specified service requirements for a structure or structural member are no longer met.

Ultimate limit states: states associated with collapse or with other similar forms of structural failure.

1.5.1 TERMS RELATING TO FIBRE-REINFORCED POLYMER

Carbon fibres: fibres consisting of very long, thin chains of carbon molecules, produced by pyrolysis of synthetic fibres such as rayon, polyacrylonitrile (PAN) or pitch in an inert atmosphere.

Continuous fibre mat: fibre mat of continuous fibre bundles that are laid criss-cross and joined together by a binding agent (or stitching). Sometimes called a continuous swirl mat.

Discontinuous fibre mat: fibre mat of short (30-50 mm) fibre bundles that are laid criss-cross and joined together by a binding agent (or stitching). Often called CSM (chopped strand mat).

Epoxy resin: thermoset resin system based on epoxy groups. Cure is produced by cross-linking of the epoxy groups through the addition of a hardener system.

Fibre spraying: method of producing FRP whereby resin and short fibres are applied in layers with a spray gun, followed by manual rolling. It is an open mould technique with one hard mould side.

Filament winding: method of producing FRP whereby resin-coated fibre bundles are wound around a mould. It is an open mould technique with one hard mould side.

First ply failure: FRP failure criterion whereby it is assumed that the maximum bearing capacity of the laminate is reached when the maximum bearing capacity of the weakest ply is reached. This usually concerns matrix failure in plies loaded transverse to the fibre.

Glass fibre: fibre made from silica (SiO_2). Distinctions are made between E glass, S glass, R glass and others, each with their own characteristics as to rigidity, strength, electrical resistance, etc. E-glass is the most common type of glass. R-glass has higher stiffness and strength than E-glass.

Glass transition temperature (T_g): The temperature at which the polymer passes from the glassy state to the rubbery state.

Hand lay-up: method of producing FRP whereby the resin is applied to the fibre reinforcement in layers by manual rolling. It is an open mould technique with one hard mould side.

Laminate: FRP built up from plies in layers, in principle with varying fibre orientation(s) and thickness(es).

Non-crimp fabric: uni-, bi- or multi-directional fibre reinforcement whereby one, two or more layers of continuous fibre glass bundles are laid in different directions on top of one another and stitched. Known as NCF (= non-crimp fabric) or stitched fabric.

Panel: flat laminate (plate) with specific parameters.

Ply: elementary layer of FRP with essentially orthotropic material properties from which a laminate is built up.

Polyester resin: thermoset resin system made from unsaturated polyester dissolved in styrene.

Prepregging: method of producing FRP whereby prepregs are placed on a mould and then consolidated using a vacuum (with or without overpressure) and heat. It is a closed mould technique with one hard and one soft mould side.

Prepregs: fibre reinforcements which are pre-impregnated with epoxy resin and then partially hardened (B-stage).

Pressure injection (RTM): method of producing FRP whereby the resin is forced into the fibre reinforcement under pressure. It is a closed mould technique with two hard mould sides.

Pultrusion: method of producing FRP whereby resin-coated fibre bundles and reinforced fibres are pulled through a mould (die) and at the same time hardened. It is a partly open and partly closed mould technique. Only suitable for profiles.

Roving: coarse, continuous (glass) fibre bundle.

Sandwich element: an element generally made up of three components: two stiff plates on the outside with a core material between them, and a (glued) joint between each plate and the core.

Sizing: surface layer around the fibre to protect the fibre and improve resin bonding.

Spray roving: short fibres (25 – 50 mm), mixed with resin, that are applied with a spray gun. The short glass fibres are obtained by cutting up glass roving.

Vacuum injection: also called Vacuum Assisted Resin Transfer Moulding (*VA-RTM*). Method of producing FRP whereby the resin is forced into the fibre reinforcement under vacuum (under pressure). It is a closed mould technique with one hard and one soft mould side or two hard mould sides.

Vinyl ester resin: thermoset resin system made from unsaturated vinyl ester dissolved in styrene. Cure is achieved by cross-linking of the unsaturated vinyl esters and styrene monomers initiated by a free radical donor (peroxide).

Woven fabric: bi-directional fibre reinforcement with continuous fibre bundles in two directions at right angles to one another, crossing each other at the binding points. In the case of coarse fibre bundles (rovings), it is known as WR (= woven roving). In the case of fine fibre bundles it is known as woven cloth or woven fabric.

1.5.2 ABBREVIATIONS

<i>CFRP</i> :	Carbon fibre reinforced polymer.
<i>CSM</i> :	Chopped strand mat (usually) or continuous swirl mat (occasionally).
<i>FRP</i> :	Fibre reinforced polymer.
<i>GFRP</i> :	Glass fibre reinforced polymer.
<i>PFRP</i> :	Pultruded fibre reinforced polymer
<i>HDT</i> :	Heat distortion temperature. The temperature at which a standard beam under controlled heating conditions reaches a prescribed deflection (EN-ISO 75).
<i>ILSS</i> :	Interlaminar shear strength.

<i>RTM:</i>	Resin transfer moulding (pressure injection).
<i>UD:</i>	Unidirectional fibre reinforcement with continuous fibre glass bundles oriented in one direction. (Common designations: UD roving, UD tape (prepreg), UD non-crimp fabric and UD woven fabric).
<i>VA-RTM:</i>	Vacuum injection (Vacuum Assisted Resin Transfer Moulding).
<i>WR:</i>	Woven Roving.

1.6 SYMBOLS

Uppercase Roman letters

E	longitudinal elastic modulus
E_d	design values of the generic action
G_{I0}	fracture energy for mode I
G_{II0}	fracture energy for mode II
L_0	buckling length of inflection
M_{Sd}	design value of bending moment
M_{Rd1}	design value of the flexural resistance
M_{Rd2}	design value of the flexural resistance related to instability
$N_{Sb,d}$	design axial force per bolt
$N_{t,Sd}$	design value of axial tensile load
$N_{t,Rd}$	design value of axial tensile resistance
$N_{c,Sd}$	design value of axial compressive load
$N_{c,Rd}$	design value of axial compressive resistance
$N_{c,Rd1}$	design value of axial compressive resistance related to material strength
$N_{c,Rd2}$	design value of axial compressive resistance related to instability
N_{Eul}	Eulerian critical load
$P_{c,Rd}$	factored buckling load for sandwich

$P_{cb,Rd}$	factored buckling load due to bending for sandwich
$P_{cs,Rd}$	factored buckling load due to shear for sandwich
R_d	capacity within a generic limit state
$R_{k,0.05}$	characteristic value of a generic quantity
T_g	glass transition temperature
T_{Rd}	design value for cross section resistance to torsion
$T_{Sd}^{(SV)}$	design value for the internal Saint-Venant's torsion
$T_{Sd}^{(w)}$	design value for the internal torsion with constrained warping
V_{Sd}	design value of shear load
V_{Rd}	design value of shear resistance
$V_{Sd,d}$	design force per bolt
X_d	design value of a generic material property
X_k	characteristic value of a generic material property

Lowercase Roman letters

c_r	row load distribution coefficient
d	bolt diameter
d_0	hole diameter in bolted joints
d_r	washer diameter
$f_{t,d}$	material design strength
$f_{c,d}$	design compressive strength of the material
$f_{V,Rd}$	design value of shear resistance of the material
$f_{V,loc,k}$	characteristic value of stress which determines the local instability
$f_{Sd,z}$	design value of compressive stress acting in Y or Z direction
$f_{Tc,Rd}$	design value of compressive strength acting in Y or Z direction
$f_{cv,d}$	design value of the core shear strength
$f_{c,d}^{(core)}$	design value of the compressive strength of the core

$f_{L,br,Rd}$	design strengths for pin-bearing failure in the 0° direction
$f_{T,br,Rd}$	design strengths for pin-bearing failure in the 90° direction
$f_{Lt,Rd}$	material design tensile strength in the direction of the element axis
$f_{Tt,Rd}$	material design tensile strength in the direction orthogonal to element axis
k_s	factor for an unknown variation coefficient according EN 1990
k_{tc}	stress concentration factor in net tension failure
k_{cc}	stress concentration factor in pin-bearing failure

Greek letters

γ_M	partial factor
γ_{M1}	partial material factor linked to uncertainties in obtaining the correct material properties
γ_{M2}	partial material factor linked to uncertainties due to the nature of the constituent parts and the production method
η_c	conversion factor
η_{ct}	conversion factor for temperature effects
η_{cm}	conversion factor for humidity effects
η_{cv}	conversion factor for creep effects
$\eta_{cv,20}$	value of η_{cv} for 20 years
η_{cf}	conversion factor for fatigue effects
μ_R	average value of a generic quantity
$\sigma_{Sd}^{(w)}$	normal stress due to bi-moment
$\sigma_{wr,Rd}^{(i,\alpha)}$	factored compressive stress for face wrinkling verification
$\sigma_{D,Rd}^{(i,\alpha)}$	factored critical dimpling stress for sandwich
σ_R	standard deviation of a generic quantity
$\tau_{Sd}^{(SV)}$	shear stress due to the Saint Venant's torsion
$\tau_{Sd}^{(w)}$	shear stress due to torsion with constrained warping

1.7 AGREEMENTS ON AXES ORIENTATIONS

The axis of orientations for fibres, plies, laminates and structural members are shown in the figures below (Figures 1.1, 1.2, 1.3, 1.4).

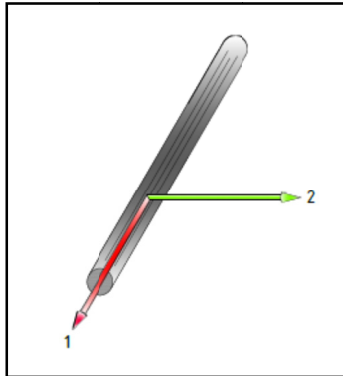

Figure 1.1 - Reference axis for elementary fibre.

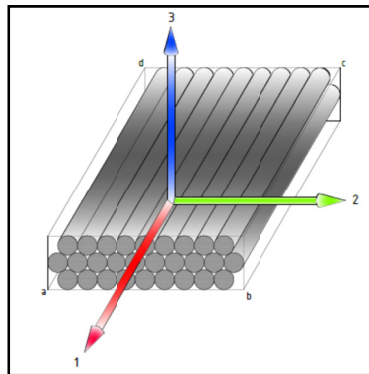

Figure 1.2- Reference axis for ply with fibre principal direction 1.

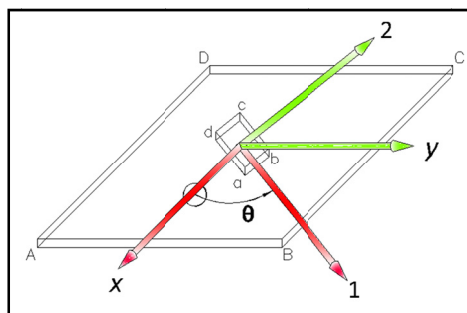

Figure 1.3- Reference axis for ply with fibre principal direction 1 (x and y are the axes of the global reference system).

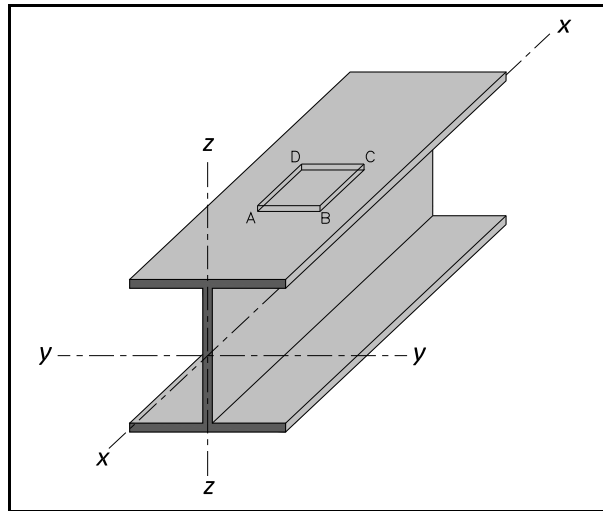

Figure 1.4 - Coordinate system for component and cross-section, with ABCD reference to laminate and ply level (y and z principal axes of the cross-section).

2 BASIS OF DESIGN

2.1 BASIC REQUIREMENTS

(1) Fibre-reinforced polymer structures should be designed and calculated in accordance with the general rules given in EN 1990, EN 1991 and the associated National Annexes. The additional provisions detailed in this report also apply.

(2) The fundamental requirements in statement 2 of EN 1990 are applicable. These are considered to have been fulfilled if:

- the design is based on limit states with the loads and load combinations specified in EN 1990 and EN 1991;
- the rules and procedures for resistance, serviceability and durability specified in this scientific and technical report have been applied;
- it has been demonstrated that the mechanical properties and geometrical tolerances applied in the calculation have been achieved, that as a minimum this has been evaluated in the least favourable locations in the structure and that the potential influence of additives and the production process has been taken into account.

(3) It should be taken care of that:

- production is certified according to ISO9000;
- adequate supervision and quality control of the production process as well as the final products should be guaranteed, and assessed by a qualified body;
- the choice of the structural elements and joints, as well as the design of the structure, should be carried out by qualified technicians and experts;
- the structure should be realized by operators with an adequate level of knowledge and experience;
- the fabrication should follow detailed specifications (see Section 9);
- the selected materials and products should be used as specified in Section 3; in particular, materials should be selected taking into account the maximum service temperature the structure will be subjected to.

(4) The design of the structure should satisfy the resistance, service and durability requisites. In the case of fire, the resistance of the structural elements as well as the joints should be adequate for the exposure time that is required. To this end, fire protection systems might be used.

(5) The design of the structure should take into account all the possible actions that could affect its service life. The risks to which it could be subjected to should be identified and, if present, either reduced or eliminated.

(6) The basic requisites are considered satisfied when the following is guaranteed:

- an appropriate choice of materials and products;
- a careful execution of structural details;
- appropriate procedures of design control, production, realization and use.

2.2 DURABILITY

(1) The design of the structure should guarantee a constant performance over time in terms of serviceability, strength and stability taking into account both the environmental conditions as well as the maintenance programme.

(2) The environmental conditions should be identified during the design phase in order to evaluate their influence on the durability of the structure, with any eventual measures being included to protect the material or the structural parts.

(3) In order to evaluate the performance of the structure in terms of its durability, theoretical models as well as tests results and studies on the behaviour of similar structures reported in the literature can be referred to.

(4) Components that are susceptible to corrosion, mechanical wear or fatigue should be designed in such a way that inspection, maintenance and repair can be carried out adequately. Furthermore these components should be accessible for inspection during use and maintenance.

(5) In order to guarantee the durability of the structure, the following should be taken into account:

- the function;
- the environmental conditions;
- the composition, properties and performance of the materials;
- suitability of the verification methods;
- the choice of the type of joints;
- the quality and level of realization control;
- the planned maintenance during the service life;
- the application of protective measures that prevent or limit deterioration in a property, based on an assessment of use, design working life, loads and required maintenance;
- the allowance in the calculations or the design for a certain level of deterioration in a material property over time or changes in load or deformation due to long-term effects that may occur, such as creep and fatigue.

(6) Depending on the type of the load which affects the durability and design life (according to EN 1990), FRP structures should be designed so as to take into account:

- the chemical-physical conditions in which the structure is used including:
 - UV,
 - temperature influences,
 - humidity, water and chemicals;
- time-dependent influences including:
 - creep,
 - wear;
- fatigue;

- accidental loads (according to EN 1991-1-7) including:
 - fire,
 - lightning strike,
 - impact,
 - explosion;
- the transportation phase;
- the installation phase;
- the inspection and maintenance.

(7) In lack of more precise approaches, the effects of material degradation could be taken into account by using appropriate conversion factors (see §2.3.6).

2.3 VERIFICATION BY THE PARTIAL FACTORS METHOD

(1) Verification of both elements and joints should be carried out in relation to both the serviceability limit states (SLS) and the ultimate limit states (ULS), as defined by the currently adopted regulations.

(2) The partial factors method should be used to verify that none of the limit states are violated during all the design phases, adopting the calculated values of actions and resistances. The following condition should be satisfied:

$$E_d \leq R_d, \quad (2.1)$$

where E_d and R_d are the design values of the generic action and the corresponding capacity (in terms of resistance or deformation) respectively, within a generic limit state.

(3) The design values can be obtained from the characteristic values with appropriate partial factors for the various limit states. Load combination factors can be set out with reference to the EN 1991 document.

(4) Statement 6 of EN 1990 applies when working with partial factors.

(5) The partial factors (material and conversion) referred to in this report exclusively apply to fibre-reinforced polymers with a fibre volume content of at least 15 %. The composite should be made up of glass fibres (E-glass fibres, R-glass fibres), carbon fibres of type HS, HT, IM or HM and aramid fibres with a thermoset matrix of unsaturated polyester, vinylester, epoxy resins.

2.3.1 LOAD EFFECTS CALCULATION

(1) The computed actions are set out in the currently adopted regulations, with reference to the service life of the structure.

2.3.1.1 LOAD EFFECTS DUE TO ERECTION OR INSTALLATION

(1) Consideration should be given to load situations during erection or installation. EN 1991-1-6 applies to the loads to be applied in the erection phase.

(2) Allowance should be made for subsidence as well as imposed deformation. Creep and relaxation should also be taken into account in this respect.

2.3.1.2 THERMAL LOAD EFFECTS

(1) The calculations should take into account the effects of thermal actions. The effects of thermal actions should be considered as well as variable loads using a partial load factor and a partial factor for load combinations.

2.3.1.3 PRESTRESSES

(1) Where prestress is applied, it is necessary to take into consideration the response of the FRP under long-term static load, such as the occurrence of creep, relaxation and creep rupture.

(2) If prestresses are applied, the properties applied in the calculation should be substantiated by test data.

2.3.2 DESIGN VALUES OF THE PROPERTIES OF MATERIALS, ELEMENTS AND PRODUCTS

(1) The values of the properties of materials, of structural elements and of products used for the joints should be determined by laboratory tests and elaborated from a statistical point of view to give characteristic values in accordance with EN 1990.

(2) In the case of preliminary designs, the ply or laminate properties could be determined from theoretical models or values available in technical literature.

(3) In verifying the resistance, the deformability as well as the stability, the characteristic values corresponding to the fractile 5% of the statistical distribution, are assumed to be used. In verifying the deformability, the mean values of the modulus of elasticity can be used. To determine the characteristic value, $R_{k\ 0.05}$, of a generic quantity the following relationship (2.2) can be used. Representative samples from the actual production should be used to allow the assumption of normal distribution. The size of the test bodies should be adapted to the actual structural dimensions in order to avoid strong variations of the results.

$$R_{k0.05} \leq \mu_R - k_s \cdot \sigma_R, \quad (2.2)$$

where:

- μ_R is the average value of the quantity,
- σ_R is the standard deviation of the quantity,
- k_s is the factor for an unknown variation coefficient according EN 1990.

(4) The design value, X_d , of the generic property of resistance or deformation of a material can be expressed, in a general form, through the following relation:

$$X_d = \eta_c \cdot \frac{X_k}{\gamma_M}, \quad (2.3)$$

where η_c is a conversion factor which takes into account, in a multiplicative manner, the peculiarity of the actual case (§2.3.5), X_k is the characteristic value of the property and γ_M is a partial factor covering uncertainty in the resistance model, and geometric deviations if these are not modelled explicitly.

(5) In Eq. (2.3), the conversion factor η_c is obtained by multiplying the specific conversion factors relevant for all the environmental actions and long term effects affecting the behaviour of the material. The values attributed to these factors are indicated in §2.3.6. As an alternative, values resulting from an adequate series of laboratory tests on prototypes could also be attributed to these coefficients.

2.3.3 DESIGN CAPACITY

(1) The design capacity, R_d , can be expressed as the following:

$$R_d = R\{X_{d,i}, a_{d,i}\}, \quad (2.4)$$

where the arguments of the function $R\{\cdot\}$ are design values (Eq. (2.3)) of mechanical properties $X_{d,i}$, and nominal values of geometric properties $a_{d,i}$.

(2) For elastic moduli the mean values can be used.

2.3.4 MATERIAL PARTIAL FACTORS

2.3.4.1 FRP LAMINATES AND STRUCTURES

(1) For ULS verifications, the material partial factor γ_M for an FRP laminate or structure should be calculated from:

$$\gamma_M = \gamma_{M1} \cdot \gamma_{M2}, \quad (2.5)$$

where:

- γ_{M1} is the partial material factor linked to uncertainties in obtaining the correct material properties; γ_{M1} is 1.0 if production process and quality system are certified by an EOTA-member; γ_{M1} is 1.15 in the case of material properties derived from tests, or 1.35 in the case of material properties derived from theoretical models or values available in technical literature;
- γ_{M2} is the partial material factor owing to uncertainties in material properties due to the nature of the constituent parts and depends on the production method. In the case of post-cured laminates the corresponding values are given in Table 2.1.

Table 2.1 – Values of γ_{M2} .

Conditions	ULS (strength)	Local stability	Global stability
Production processes and properties of FRP ¹ with $\sigma_R \leq 0,10$	1.35	1.5	1.35
Production processes and properties of FRP ¹ with $0,10 < \sigma_R \leq 0,17$	1.6	2.0	1.5

¹ The variation coefficient σ_R should be determined from tests (EN1990, Annex D).

Post-cured means that the T_g and resin properties specified in the design have as a minimum been realized before the supporting structure is put into use (e.g. post-curing can be achieved by controlled heat treatment). For non-post cured laminates the values in Table 2.1 should be multiplied by 1.2.

- (2) For SLS verifications, the material partial factor γ_{M1} and γ_{M2} should be put equal to 1.0.
- (3) In the case of sandwich structures with foam core, the following values (Table 2.2) of the partial material factors γ_{M2} for foam could be utilized:

Table 2.2 – Partial factors γ_{M2} for core materials.

Core material	Kind of verification		
	Strength	Local stability	Global Stability
Foam under shear	1.5	1.7	1.2
Foam under compression	1.2	1.4	1.2

- (4) For other core materials, the partial factors γ_{M2} should be derived by test according to EN1990 Annex D.

2.3.4.2 JOINTS

- (1) For bonded joints with structural adhesives, the material partial factors γ_{M1} and γ_{M2} at ULS could be those given in Table 2.3.

Table 2.3 – Values of the partial safety coefficients γ_{M1} and γ_{M2} for adhesives joints.

Adhesive application method	γ_{M1}
Manual application with few controls of the thickness and surface pre-treatment	1.5
Manual application with systematic control of the thickness and surface pre-treatment	1.25
Identified application with defined and repeatable controlled parameters including surface pre-treatment	1
Determination of the mechanical properties of the adhesive	γ_{M2}
Characteristic strength values in accordance with EN1990 annex D for $\sigma_R \leq 0.10$	1.2
Characteristic strength values in accordance with EN1990 annex D for $0.10 < \sigma_R \leq 0.17$	1.5

- (2) For bolted joints, the value of the partial factor of the joined FRP elements, γ_M , for ULS, should be determined according to Table 2.1.
- (3) In order to verify the single parts of the joints made with materials other than FRP, the factor γ_M of those parts should be determined in accordance with the currently adopted regulations or any other certified set of regulations.

2.3.5 APPROACH TO SPECIAL PROBLEMS BY USING CONVERSION FACTORS

- (1) Several reference values which could be attributed to the conversion factor η_c , introduced in §2.3.3, are reported in the next section. They could be used in order to determine the reduced values of the design parameters. They follow from either environmental degradation effects or load duration effects.
- (2) Protective coverings already tested as able to mitigate the environmental degradation and to allow the service life of the structure to remain unaltered, should be used in aggressive environments. In the presence of an adequate protective system able to counteract a specific environmental effect, the value of the corresponding conversion factor can be assumed to be equal to 1.0.

2.3.6 RELEVANT CONVERSION FACTORS

(1) The total conversion factor, η_c , for the limit states analysis should be determined from:

$$\eta_c = \eta_{ct} \cdot \eta_{cm} \cdot \eta_{cv} \cdot \eta_{cf}, \quad (2.6)$$

where:

- η_{ct} is the conversion factor for temperature effects;
- η_{cm} is the conversion factor for humidity effects;
- η_{cv} is the conversion factor for creep effects;
- η_{cf} is the conversion factor for fatigue effects.

If appropriate, other conversion factors can be added in the product above, for example in the case of alkaline attack, freezing-thawing cycles, etc.

(2) For every given situation it is necessary to determine which conversion factors are applicable. Table 2.4 indicates the main conversion factors that could be taken into account in different limit states. These values only concern glass and carbon fibres, as well as thermoset resins (polyester, vinylester, epoxy and phenolic).

Table 2.4 – Conversion factors to be taken into account.

Influencing factor	Aspect being verified						
	Strength (ULS)	Stability (ULS)	Fatigue (ULS)	Creep (SLS)	Momentary deformation (SLS)	Comfort (vibrations) (SLS)	Damage (SLS)
η_{ct}	√	√	√	√	√	√	√
η_{cm}	√	√	√	√	√	√	√
η_{cv}	√	√		√			√
η_{cf}		√		√	√	√	√

2.3.6.1 TEMPERATURE

(1) For normal temperature service conditions (See § 1.4(2)), the conversion factor for temperature effects could be as follows:

- for verification of strength: $\eta_{ct} = 0.9$;
- for verification of deformability and stability:
 - at a service temperature of $T_d = T_g - 40$ °C: $\eta_{ct} = 1.0$,
 - at a service temperature of $T_g - 40$ °C $< T_d < T_g - 20$ °C: $\eta_{ct} = 0.9$;
- instead of the momentary T_g , the momentary HDT of the resin can be also used for the calculation.

(2) For elevated temperature service conditions (See § 1.4 (2)), the conversion factor for temperature effects should be determined based on testing.

2.3.6.2 HUMIDITY

(1) The values of the conversion factor for humidity effects η_{cm} could be those given in Table 2.5.

Table 2.5 – Values of η_{cm}

Media class	Conversion factor		Influence
	Cured	Non-post cured/ hardened	
I	1.0	1.0	Without influence, e.g. dry goods, indoor climate
II	0.9	0.8	Very small influence, outdoor climate, < 30°C
III	0.8	Not allowed	Small influence, continuously exposed to water, strong UV exposure, 30-40°C

2.3.6.3 CREEP

(1) Depending on the categories of the load duration classes (Tables 2.6 and 2.7), verification may need to be undertaken. On each level of requested proof, all the effects having a longer duration of influence will also be taken into account. The corresponding conversion factors might be derived from the basic value of load duration of twenty years $\eta_{cv,20}$ (Annex A). The basic values are listed in the Table 2.8.

Table 2.6 – Load-duration classes.

Load-duration classes for high-building constructions	Order of accumulated duration of characteristic load
Permanent	more than 10 years
Long-term	6 months – 10 years
Medium-term	1 week – 6 months
Short-term	less than 1 week
Instantaneous	less than 1 minute

Table 2.7 – Classification of loads.

Action	Classes
Dead load	permanent
Perpendicular service loads for building constructions	
Living and comfort space, office space, work space, corridors	medium
Rooms, assembly rooms and spaces planned to be used by groups	short
Salesrooms	medium
Factories and workshops, stables, stockrooms and entrances, spaces for significant number of persons	long
Traffic and parking area for light-weight vehicles	Medium
Access ramp to traffic and parking area	Short
Area for the use of counterbalance forklift trucks	Medium
Non accessible roofs, staircases or landings, accessions, balconies or the like	Short
Horizontal loads for building constructions	
Live loads due to persons on parapets, balustrades and other retaining devices	Short
Horizontal loads of crane and machine operation	short
Vertical live loads on bridges	
Highways and streets with high or medium truck occurrence, main roads with low truck occurrence	Long
Local streets with low truck occurrence	Medium
Agricultural roads	Short
Wind load	short

Table 2.8 – Conversion factors for creep effects.

Level of proof	Estimated loads	Conversion factors $\eta_{cv}(t_v)$ according to the tabular value $\eta_{cv,20}$ and the duration of exposure t_v					
		0.67	0.5	0.4	0.33	0.29	0.25
tabular value $\eta_{cv,20}$ (20 years)	---	0.67	0.5	0.4	0.33	0.29	0.25
Permanent 50 years	permanent	0.65	0.48	0.38	0.31	0.27	0.23
Long-term 10 years	permanent, long	0.69	0.51	0.42	0.35	0.30	0.27
Medium-term 6 months	permanent, long, medium	0.74	0.59	0.49	0.43	0.38	0.34
Short-term 1 week	permanent, long, medium, short	0.80	0.67	0.59	0.53	0.49	0.45
Instantaneous 1 minute	permanent, long, medium, short, very short	1.00	1.00	1.00	1.00	1.00	1.00

- (2) The corresponding modification conversion factor $\eta_{cv}(t_v)$ could be taken from the Figure 2.1.
- (3) As alternative, the modification factor $\eta_{cv}(t_v)$ could be determined by the following relationship:

$$\eta_{cv}(t_v) = (\eta_{cv,20})^T, \quad T = 0.253 + \text{Log}(t_v); \quad (2.7)$$

where η_{cv} :

- $\eta_{cv,20}$ is the basic value of η_{cv} for 20 years according to Table 2.8,
 - $\text{Log}(t_v)$ is the decadic logarithm of the accumulated duration of load t_v in hours [h].
- (4) Creep should be verified for permanent and quasi permanent loading conditions.
- (5) In the double logarithmic scaling, the conversion factor results in straight curves (Figure 2.1).

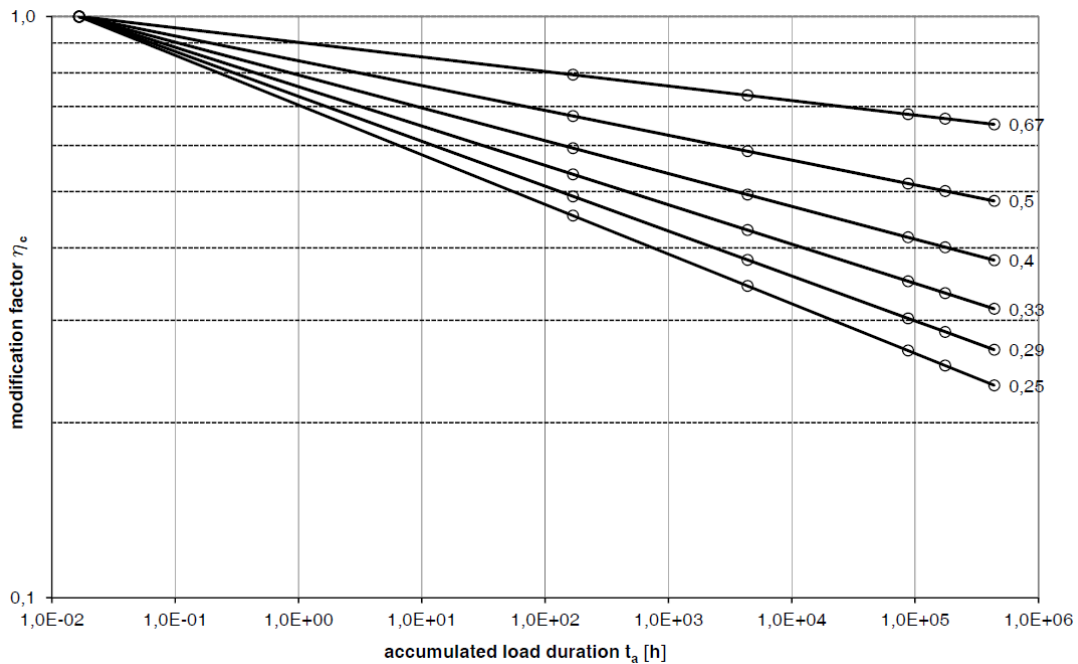

Figure 2.1 - Dependency of the conversion factors η_{cv} from the value $\eta_{cv,20}$ given in Table 2.8 and the accumulated load duration t_v .

2.3.6.4 FATIGUE

- (1) For structures subject to cyclic variations fatigue should be considered in the size of the load, and where the number of expected fatigue load cycles is expected to exceed 5000, or where the absolute maximum value of the cyclic load is greater than 40 % of the fully factored load.
- (2) Fatigue has an effect on both stiffness and strength. In the Serviceability Limit State verification allowance should be made for loss of stiffness in the material due to fatigue using a conversion factor for fatigue effects of $\eta_{cf} = 0.9$.
- (3) For ULS a verification of fatigue resistance should be performed according to Section 6.5.
- (4) For a detailed consideration, stiffness reduction in the case of fatigue in undisturbed material might be directly determined from tests instead of calculation using the conversion factor. The stated values do not apply to connections or details.

(5) If the influence of fatigue is a significant design load case, the conversion factors should be determined by experiments.

2.3.6.5 ADHESIVE JOINTS

(1) The presence of water or damp atmosphere or aggressive environment can drastically lower the long term performance of the adhesive joint (especially in the case of poor surface pre-treatments).

(2) The degradation effects on stiffness and strength of adhesive joints should be determined by laboratory tests for the specific adhesive type and adherent combination, surface pre-treatment and cure conditions.

(3) In the case of preliminary design, the degradation effects (ageing, temperature, moisture, chemicals) for the adhesive could be taken into account by using the values of the conversion factor η_c given above.

2.4 REQUIREMENTS FOR FASTENERS

(1) Metal fasteners with a protective coating may be used in the open air if they can be inspected and replaced. Otherwise, fasteners in the open air should be made of a corrosion-resistant material, according to EN1993-1-8 and EN 1090.

(2) When using metal fasteners in carbon fibre reinforced structures, insulation should be used to prevent galvanic corrosion.

2.5 REFERENCES

Borowicz, D.T., Bank, L.C., Behavior of pultruded fiber-reinforced polymer beams subjected to concentrated loads in the plane of the web (2011). *Journal of Composites for Construction*, Vol. 15 (2), pp. 229-238.

Bakis, C., Bank, L., Brown, V., Cosenza, E., Davalos, J., Lesko, J., Machida, A., Rizkalla, S., Triantafillou, T., *Fiber-Reinforced Polymer Composites for Construction—State-of-the-Art Review (2002)*. *J. Composites for Construction*, Vol. 6(2), pp. 73–87.

Ellingwood, B., MacGregor, J.G., Galambos, T.V, Cornell, C.A., *Probability Based Load Criteria: Load Factors and Load Combinations (1982)*. *J. Struct. Div. ASCE*, Vol. 108 (5), pp. 978-997.

Ellingwood, B.R., *Toward load and resistance factor design for fiber-reinforced polymer (FRP) composite structures (2003)*. *J. Struct. Engineering. ASCE*, Vol. 129 (4), pp. 449-458.

Engdinez, M., Zureick, A.H., *Deflection response of glass fiber-reinforced pultruded components in hot weather climates (2008)*. *J. Composites for Const. ASCE*, Vol. 12 (3), pp. 355-363.

Feo, L., Mancusi, G., *The influence of the shear deformations on the local stress state of pultruded composite profiles (2013)*. *Mechanics Research Communications*, Vol. 47, pp. 44-49.

King, L., Toutanji, H., Vuddandam, R., Load and resistance factor design of fiber reinforced polymer composite bridge deck (2012). *Composites Part B: Engineering*, Vol. 43 (2), pp. 673-680.

Minghini, F., Tullini, N., Laudiero, F., Identification of the short-term full-section moduli of pultruded FRP profiles using bending tests (2014). *Journal of Composites for Construction*, Vol. 18 (1).

Thumrongvut, J., Seangatith, S., An experimental study on the performance of fixed-end supported PFRP channel beams under flexure (2013). *Advanced Materials Research*, Vol. 702, pp. 31-36.

Wang, Y., and Zureick, A.H. Characterization of the Longitudinal Tensile Behavior of Pultruded I-shape Structural Members Using Coupon Specimens (1994). *Composite Structures*, Vol. 29, pp. 463-472.

Zureick, A. H., Polymer composites for infrastructure (1997). *Durability Analysis of Composite Systems Proc. 3rd Int.Conf.* (Edited by Reifsnider, Dillardand Cardon), A.A. Balkema, Rotterdam, the Netherlands, pp. 181-184.

Zureick, A., Scott D., Short-Term Behavior and Design of Fiber-Reinforced Polymeric Slender Members under Axial Compression (1997). *J. Composites for Const., ASCE*, Vol. 1 (4), pp.140-149.

3 MATERIALS

3.1 GENERAL

- (1) The materials used should be suitable for the intended application.
- (2) FRP materials should be:
 - unambiguously identified by the manufacturer;
 - certified under the responsibility of the same manufacturer;
 - accepted on site through the acquisition and verification of all documents given by the manufacturer, as well as by any experimental tests for acceptance.
- (3) This document relates to the design and calculation of FRP structures manufactured from the fibre types and thermoset resin types within the application area, as stated in Section 1, i.e.:
 - fibres: E glass fibre, HS, HT and HM carbon fibre, aramid fibre;
 - thermoset resins: unsaturated polyester, vinylester, epoxy resins.
- (4) Other resin and fibre types might be used providing that suitability for the application has been demonstrated.
- (5) Properties of raw materials should be specified according to EN 16245.
- (6) For pultrusion, EN 13706 should be used as a product classification standard. The reliability of material properties should be according to EN 1990.
- (7) Characteristic values used in a design should be determined by laboratory tests according to EN1990. For composites with a single fibre direction (as in the case of pultruded profiles) at least the following properties should be determined:

Table 3.1 – Mechanical properties.

Property	Test method
Tensile modulus \parallel	EN ISO 527-4
Tensile modulus \perp	EN ISO 527-4
Tensile strength \parallel	EN ISO 527-4
Tensile strength \perp	EN ISO 527-4
Compressive modulus \parallel	EN ISO 14126
Compressive modulus \perp	EN ISO 14126
Compressive strength \parallel	EN ISO 14126
Compressive strength \perp	EN ISO 14126
Pin-bearing strength \parallel	EN 13706-2
Pin-bearing strength \perp	EN 13706-2
Interlaminar shear strength \parallel	EN ISO 14130
Interlaminar shear strength \perp	EN ISO 14130
Poisson's ratio \parallel	EN ISO 527-4
Poisson's ratio \perp	EN ISO 527-4

\parallel along the fibre direction, \perp along the direction orthogonal to the fibres

Other mechanical and physical properties may be required by agreement between customer and supplier.

(8) A common case is that of balanced symmetric laminates with fibres lying along two orthogonal directions. In all the following the report will only refer to such kind of laminates.

As a reminder, it should be noted that a laminate is symmetric if layers of the same material, thickness, and orientation are symmetrically located with respect to the middle surface of the laminate. Furthermore, in the case considered here (balanced laminates) for each 0° -layer there is a complementary 90° -layer, also of the same thickness and material. In this case a set of equivalent laminate moduli (E_x , E_y , G_{xy} , ν_{xy}) can be defined. These moduli represent the stiffness of a fictitious, equivalent, orthotropic plate that behaves like the actual laminate under in-plane loads. For such a laminate the directions x and y play the role of principal directions of orthotropy.

In this case the properties in Table 3.1 should be determined with respect to such two directions.

(9) In case of other kinds of laminates the mechanical and physical properties to be determined should be required by agreement between customer and supplier.

(10) The resin used should be appropriate to the surface treatment ('sizing') of the fibre. The choice of resin should be appropriate to the required properties, such as glass transition temperature, chemical resistance, fire reaction properties and electrical conductivity. Additives and fillers may be added to the resin to provide its specific properties. The effect of additives and fillers on the mechanical properties should be taken into account.

(11) The cured unreinforced resin should satisfy the following conditions:

- strain on failure in tension, as per EN-ISO 527, at least 1.8 %;
- glass transition temperature (T_g), as per EN-ISO 6721-11 (taken as the onset of the storage modulus), at least 20 °C above the maximum service temperature and at least 60 °C.

(12) The characteristic values of FRPs mechanical parameters should be sufficiently stable with respect to the degradation induced by environmental actions (see §3.2).

3.1.1 FIBRES, RESINS, ADHESIVE, PLY AND LAMINATE PROPERTIES

(1) When using values available in the technical literature (see § 2.3.2 (2)), allowance should be made in the design and calculation for the influence of fibre sizing and possible differences between different products suppliers. Annex B gives indicative values for fibre, resin, ply and laminate properties, to be used in preliminary design. This annex also provides analytical models useful for predicting such properties.

(2) The strength of the adhesive should be determined by test in accordance with the representative ISO or ASTM tests.

3.1.2 FRP BEAM ELEMENTS

(1) With reference to FRP beam elements (pultruded or not), in addition to the properties relative to the material, the evaluation of sectional properties should be done according to EN 13706. The reliability of properties should be according to EN 1990.

3.1.3 SANDWICH: CORES AND PANELS

(1) The following physical and mechanical properties should be required in order to qualify and certify sandwich structures:

- Density of sandwich core materials (ASTM C271-94);
- Water absorption of core materials for structural sandwich constructions (ASTM C272-96);
- Shear properties of sandwich core materials (ASTM C273-94);
- Flatwise tensile strength of sandwich constructions (ASTM C297-94);
- Delamination strength of honeycomb core materials (ASTM C363-94);
- Edgewise compressive strength of sandwich constructions (ASTM C364-94);
- Flatwise compressive properties of sandwich cores (ASTM C365-94);
- Measurement of thickness of sandwich cores (ASTM C366-94);
- Flexural properties of sandwich constructions (ASTM C393-94);
- Shear fatigue of sandwich core materials (ASTM C394-94);
- Flexure creep of sandwich constructions (ASTM C480-94);
- Laboratory aging of sandwich constructions (ASTM C481-94);
- Water migration in honeycomb core material (ASTM F1645-96).

(2) Further laboratory tests on sandwich panels should be required from the supplier in order to certify the strength and buckling performance of the delivered products.

3.2 DURABILITY TESTS

(1) When required, the durability tests on FRP materials could consist of the following tests regarding long-term environmental and biological actions and abrasion:

- Plastics — Evaluation of the action of microorganisms (ISO 846)
- Plastics — Methods of exposure to solar radiation (ISO 877 all parts)
- Plastics — Determination of changes in colour and variations in properties after exposure to daylight under glass, natural weathering or laboratory light sources (ISO 4582)
- Plastics — Methods of exposure to laboratory light sources (ISO 4892 all parts)
- Plastics — Determination of the effects of exposure to damp heat, water spray and salt mist (ISO 4611)

- Plastics — Determination of water absorption (ISO 62)
- Plastics — Methods of test for the determination of the effects of immersion in liquid chemicals (ISO 175)
- Determining Chemical Resistance of Thermosetting Resins Used in Glass-Fiber-Reinforced Structures Intended for Liquid Service (ASTM C 281)
- Plastics — Methods for marine exposure (ISO 15314)
- Testing Water Resistance of Coatings in 100% Relative Humidity (ASTM 2247)
- Paints and varnishes — Determination of resistance to humidity (ISO 6270)
- Plastics — Determination of resistance to environmental stress cracking (ESC) (ISO 22088 all parts)
- Plastics — Friction and wear by sliding — Identification of test parameters (ISO 6601)
- Plastics—Determination of resistance to wear by abrasive wheels (ISO 9352)
- Effect of Moisture and Temperature on Adhesive Bonds (ASTM D 1151)
- Atmospheric exposure of adhesive-bonded joints and structure (ASTM D 1828)
- Determining durability of adhesive joints stressed in peel (ASTM D 2918)
- Determining durability of adhesive joints stressed in shear by tension loading (ASTM D 2919)
- Adhesive-bonded surface durability of aluminium (wedge test) (ASTM D 3762)

(2) When required, freeze-thaw tests might be performed. Freeze-thaw tests could be limited to the tensile behaviour and executed with the following procedure:

- i. The specimens are stabilized in a climatic chamber for a week under a RH=100% and temperature of 38°C. Then, the specimens are submitted to 100 cycles of at least 4 hours at -18°C followed by 12 hours in the climatic chamber. A minimum of ten specimens are required: five are to be conditioned and five are to be used as control specimens.
- ii. At the end of the test the specimens are inspected in order to identify superficial alteration, scaling and cracking. Finally the specimens should be tested for strengths and elastic moduli.

The test is positive if the specimens retain at least 85% of the strengths and elastic moduli of control specimens, and no visible defect is identified on their surface.

(3) When required, aging tests might be performed. Aging tests could be limited to the tensile behaviour and executed with the following procedure:

- i. Both wet and dry composite specimens are aged according to Table 3.2. Both exposed and control specimens are then tested for strengths and elastic moduli. A minimum of sixty specimens is required: thirty for the duration of 1000 hours and thirty for the duration of 3000 hours. Within each duration, five specimens are to be conditioned in a moist environment and five are to be used as control specimens; further ten specimens are used for the saline environment and the last ten specimens for the alkaline one.

- ii. Acceptance is positive if under examination with 5X magnification no erosion, cracking and crazing is present. The conditioned specimens should retain the percentage of tensile strength and modulus given in Table 3.2, with respect to the unconditioned ones.

Table 3.2 – Aging test procedure.

Environmental durability test	Reference Standard	Test parameters	Test duration (hours)	Retained values (%)
Moisture resistance	ASTM D 2247-11 ASTM E 104-02	Relative humidity: $\geq 90\%$ temperature: $38 \pm 2 \text{ }^\circ\text{C}$	1000	85
Salt water resistance	ASTM D 1141-98 ASTM C 581-03	immersion at $23 \pm 2 \text{ }^\circ\text{C}$		
Alkali resistance	ASTM D7705-7705M	immersion in a dilution with pH= 9,5 or larger; temperature: $23 \pm 2 \text{ }^\circ\text{C}$	3000	80

3.3 REFERENCES

Ascione L., Feo L., Mechanical behaviour of composites for construction (2012). *Encyclopaedia of Composites*, p. 1–25. John Wiley and Sons, New York, NY.

Bank, L. C. *Composites for Construction* (2006). John Wiley and Sons, New York, NY.

Barbero, E. *Introduction to composite materials design* (1998). Taylor & Francis.

Bitzer, Tom. *Honeycomb Technology: Materials, design, manufacturing, applications and testing* (1997). Chapman & Hall.

Christensen, R. M., *Mechanics of Composite Materials* (2005). Dover Publications NY.

Ferry, J.D. *Viscoelastic properties of polymers* (1980). John Wiley and Sons, New York, NY.

4 DURABILITY

(1) This section describes the effects and related measures that have an impact on the material properties of fibre-reinforced polymers. Based on the correct selection and processing of materials and protective measures, conversion factors are specified to account for the effects of temperature, humidity, creep and changing load, as in § 2.3.6. This chapter deals with measures to protect the structure's function from aging and weathering.

4.1 GENERAL

(1) Durability means that all requirements on reliability are to be met throughout the design working life.

(2) Components of structures should be designed such that:

- They will fulfil the requirements throughout their design working life, in principle without repair or replacement. For this purpose the risk of failure at the beginning of the design working life will remain unchanged such that, when allowing for normal increase in the risk of failure due to aging of the structure, the risk of failure at the end of the design working life will remain below the required limit value.
- They, or the complete structure of which they are part of, can be inspected once or repeatedly and where necessary repaired throughout the entire design working life such that, the risk of failure of that component always remains below the required limit value.

(3) The second of the methods above is recommended for FRP structures where experience of using the material in structures is limited. With the correct choice of materials and production, FRP structures generally need low maintenance. Conversion factors allow then for the anticipated effects of aging, climate, etc., throughout the service life.

(4) When realizing the required protection for the structure, it is necessary to take into account the use, the design service life (see EN 1990), the maintenance programme and the applied loads.

(5) The effects of long-term and varying loads and the environment in which the structure is located should be taken into account (see § 4.2).

(6) Laminate characteristics having a major impact on the durability of an FRP component are:

- void content (number of air bubbles);
- cure process – correct cure (e.g. post curing contributes to a longer service life);
- chemical resistance of the resin – the resin and protective substances used should be resistant to the climate of use. It is advisable to assess the suitability of the resin in consultation with the resin supplier;

- fibre-resin interface. This is determined by factors including the fibre type, resin, sizing and process conditions, including humidity and pressure during cross-linking.
- (7) The ILSS provides a measure of the fibre-resin bond. The achieved glass transition temperature T_g provides a measure for the degree of cure. As part of the inspection of properties, this report specifies that the ILSS and T_g are verified by tests.
- (8) When a resin suitable for the ambient climate is correctly processed, in combination with protection against UV by means of a coating, a durable material is generally obtained and the factors stated in § 2.3.5 are sufficient for indoor and outdoor application. Practical experience and accelerated aging tests have shown that a service life for FRP structures of 50 years or more can be achieved without any problem.
- (9) The influence of additives and fillers on durability should be taken into account in the design. In particular, consideration should be given to the influence of fire-retardant additives on durability.
- (10) Too high a concentration of fillers can adversely affect durability. Its influence depends on whether a gel coat has been used or whether another coating has been applied afterwards. Every combination of fillers and resin behaves in a unique way. These factors should be taken into account.

4.2 MEASURES FOR SPECIFIC ENVIRONMENTAL CONDITIONS

4.2.1 UV RADIATION

- (1) The structure should be protected against UV radiation through the use of additives in the material or by means of surface protection.
- (2) In case of aramid fibre reinforcement, exposure of the fibre to UV radiation should be prevented.
- (3) UV radiation can cause degradation of polymers and reduce the strength of the resin and in some cases, for example with aramid fibres, even of the fibre reinforcement. Glass fibres and carbon fibres exhibit good resistance to UV radiation.

Examples of measures to protect against UV are:

- the application of a gel coat, top coat or layer of paint;
- the use of a UV resistant resin;
- the addition of pigment or UV absorbers to the resin.

4.2.2 THERMAL MATERIAL EFFECTS

- (1) The effects of any degradation in material properties under the influence of raised temperature should be included in the calculation by:
- the use of a partial conversion factor for temperature effects as detailed in § 2.3.6,

or

- directly deriving this effect through tests on materials at this raised temperature.

(2) FRP loses strength and stiffness under the influence of temperature on the resin properties. The glass transition temperature (T_g) of the used resin, as determined by EN-ISO 6721-11 (taken as the onset of the storage modulus), should be at least 20 °C above the maximum service temperature of the structure.

(3) As an alternative to the glass transition temperature, assumptions may also be based on the heat deflection temperature (HDT), as determined by EN-ISO 75. The HDT should be at least 20 °C above the maximum service temperature of the structure. For aramid fibres the maximum permitted service temperature and the material behaviour at temperatures higher than 60 °C should be determined in consultation with the material supplier.

(4) Aramid fibres have a more limited thermal range than glass fibres and carbon fibres. The properties of aramid fibres are liable to change at around 100 °C.

(5) The colour of the composite material may have a great importance on the temperature reached inside the material. Dark colours may increase the temperature above the required limit. Tests are required to assess these effects.

(6) For sandwich materials with insulating cores (foam, woods, balsa...), the temperature can be very different between the top and bottom faces, when exposed to a source of heating (e.g. the sun). This can lead to an undesired curvature, to fatigue phenomenon and even to damage as described in section 6. These effects should be taken into account. For hollow cores, this problem does not really exist.

4.2.3 HUMIDITY, WATER AND CHEMICALS

(1) The effects of any degradation in material properties under the influence of humidity, water and chemicals should be included in the calculation by:

- the use of a partial conversion factor for humidity and water as detailed in § 2.3.6;
- or
- directly deriving this effect through tests on materials that are exposed to the actual actions.

(2) FRP loses strength and stiffness under the influence of humidity, water and chemicals. No conversion factors have been defined for the influence of chemicals. This effect should be determined by tests.

(3) Loss of strength and stiffness is a slow and in some cases irreversible process. The resistance of FRP to humidity, water and other chemicals is governed in the first instance by the resin. The resins and fibres considered in this report are generally well resistant to chemicals. Good embedding in a resin isolates and protects the fibre and will reduce the degree of penetration. Carbon fibre is resistant to both acidic and basic environments. Glass fibre is resistant to acids but may (except for especially resistant types) degrade in a basic environment. Isopolyester, epoxy and vinyl ester resins generally show good resistance to (salt) water.

(4) The partial factors in § 2.3.6 apply where there is no continuous exposure to service temperatures above 40 °C. If the structure is continuously exposed to high concentrations of moisture or chemicals combined with a long-term service temperature above 40 °C, the effect of this should be determined by means of tests.

(5) In case of long-term exposure to water or high concentrations of chemicals, the laminate should be completely hardened before being subject to any loads and a coating or chemical barrier layer should be applied.

(6) Exposure to water can lead to the growth of algae (marine fouling), which might damage the coating. Measures such as regular cleaning and/or the use of an anti-fouling coating can be applied if necessary.

(7) The case of sandwich structures is very sensitive. Humidity can lead to debonding between the core and the faces. Humidity diffusion inside the core should be avoided (by adequate protection/covering of open/free edges, protection of holes, etc.).

4.2.4 STATIC CHARGE

(1) If required by the application, provisions should be put in place to divert electrical charges. For example, through external measures such as a lightning conductor or the use of a conducting mat on the surface of the FRP.

(2) Fibre-reinforced polymers are non-conductive, unless they are filled with conductive particles or fibres, such as carbon fibres.

4.2.5 FIRE

(1) The fire safety of FRP structural components and joints should comply with applicable building codes, in what concerns both fire reaction and fire resistance requirements.

(2) In what concerns fire reaction, most resin systems used in FRP components are flammable and, under fire conditions, release heat and smoke and spread flames. Conventional thermoset resin systems do not emit toxic gases and do not drip. This issue should be taken into consideration.

(3) The fire reaction properties of FRP components can be considerably improved by using (i) inherently flame retardant resins (e.g., phenolics), fillers, flame retardants or passive fire protection systems (e.g. coatings, boards).

(4) If fillers or flame retardants are used, their influence on the FRP mechanical properties should be taken into account.

(5) In what concerns fire resistance, the strength and stiffness properties of FRP components are temperature-dependent. In general, when the glass transition temperature of the resin is exceeded, the mechanical properties are notably reduced, particularly those that are more matrix-dependent. Due to their low thermal conductivity, the temperature increase in FRP components when subjected to fire is relatively slow (namely when compared to metallic materials).

- (6) The fire resistance of FRP components is very much dependent on:
- the structural function of the FRP members (higher for members in bending, lower for members in compression),
 - the number of sides exposed to fire,
 - the cross-section geometry (higher for sections with thicker walls and closed geometry, particularly if multi-cellular).
- (7) The fire resistance of FRP components can be significantly improved by using:
- passive (e.g., coatings, boards),
or
 - active (e.g., sprinklers, water cooling) fire protection systems.
- (8) Fire protection systems developed for other materials (e.g., steel), cannot be applied straightforwardly to FRP structures.

5 BASIS OF STRUCTURAL DESIGN

5.1 ANALYSIS CRITERIA

- (1) The analysis of the structural response should be carried out taking into account the elastic behaviour up to failure and, if necessary, the orthotropic nature of the materials. The stress on the structural elements and joints should be determined through a global analysis of the structure, considering, when relevant, the deformability of the joints.
- (2) The second order effects should also be taken into account in the analysis, if they are significant.
- (3) The analysis of thin-walled FRP profiles with open section subjected to torsion should be carried out taking into account both the primary and the secondary torsional stiffness.
- (4) For bolted joints, the strains of every single bolt should be evaluated taking into account the elastic properties of the structural elements connected to them. The verification should be carried out considering all the possible failure modes of the joints.
- (5) For adhesively bonded joints, the verification is carried out in terms of delamination by considering the interface fracture energy and the possible fracture modes. Cyclic loading of the bonded joints should be carefully considered in the verification.
- (6) The method of analysis should be relevant for the actual behaviour.
- (7) The anisotropic elastic moduli of composite materials, laminates or sandwich structures may be obtained by direct experimental testing. The use of classical theoretical models for composite materials allows one to only obtain indicative values (see Appendix B).
- (8) When finite element analysis is performed, the definition and handling of failure criteria should be clearly defined and described.
- (9) When analysis computer programmes are used, a reference case should be presented for showing their suitability.

5.2 VERIFICATION CRITERIA

- (1) The verification of resistance should be carried out considering the eventual simultaneous presence of more than one stress characteristic.
- (2) The verification of stability should take into account the eventual interaction between local and global instability phenomena. A local verification of the parts under compression should be carried out when the constraint conditions prevent global instability. The verification of stability should take into account the presence of imperfections.
- (3) In a quasi-permanent load combination, the verification of local and global stability should be carried out by introducing reduced values for the elasticity moduli due to the effect of the viscous strain, as highlighted in § 2.3.6.3.

(4) In the case of numerical modelling, the design value of the property of interest (e.g. the design resistance capacity, R_d) should be obtained from an incremental analysis which takes into account the imperfections, when introducing the design values of the mechanical properties.

(5) In particular, EN 13706-2 gives the dimensional tolerances of geometric imperfections in the form of out-of-straightness, flatness, twist, and angularity of the structural FRP profiles.

(6) The inclusion of all of these imperfections could be scoped by modelling a single (dominant) imperfection with appropriate magnitude. For instance the initial imperfection of the out-of-straightness, by attributing to it the amplitude of span/125.

5.3 STRAIN EVALUATION

(1) Both the flexural deformability and the shear deformability should be taken into account in order to evaluate the deflection of the structural elements under bending.

(2) The calculation of shear deformability should be carefully treated and referenced, since composite and anisotropic materials have a very specific behaviour in this regard, especially sandwich panels involving cores, which have low shear modulus.

5.4 BEHAVIOUR IN THE CASE OF FIRE

(1) The fire resistance of FRP structural components and joints should conform to applicable building codes.

(2) The mechanical properties of FRP materials are highly sensitive to elevated temperatures, particularly for matrix-dependent properties. In fact, when the FRP temperature approaches or exceeds the resin glass transition temperature, T_g , the strength and moduli are notably reduced.

(3) Under conditions of exposure to fire, the mechanical properties of FRP materials could be significantly prevented from decreasing by adopting either passive fire protection systems (e.g., coatings or boards with an appropriate thickness) or active protection systems (e.g., sprinklers, water cooling).

(4) The accidental load combinations indicated in the currently adopted guidelines should be used in fire design verifications for a given established exposure time.

5.5 DESIGN ASSISTED BY TESTING

(1) The design and calculation of structures or structural elements might be supported by tests. Information concerning design supported by testing is given in the annex D of EN 1990.

5.6 REFERENCES

Vinson, J.R. *The Behavior of Shells Composed of Isotropic and Composite Materials* (1993). Kluwer Academic Publishers.

Barbero, Ever J. *Introduction to Composite Materials Design* (1998). Taylor & Francis.

Gay, Daniel, HOA, Suong V., et TSAI, Stephen W. *Composite materials: design and applications* (2002). CRC press.

Nicolais, L., Borzacchiello, A, et Stuart, M. Lee, *Encyclopaedia of Composites* (2012). John Wiley and Sons, New York, NY.

Reddy, J.N. *Mechanics of Laminated Composite Plates* (1997). CRC press.

6 ULTIMATE LIMIT STATES

6.1 GENERAL

(1) In this section the basic ULS verifications will be presented. In particular, the following structural elements will be examined:

- Profiles;
- Laminated plates and shells;
- Sandwich panels.

6.2 ULTIMATE LIMIT STATES OF PROFILES

The following most common cases of internal beam reactions are examined:

- Normal Force: Axial Tension (see § 6.2.1.1), Axial Compression (see § 6.2.1.2);
- Flexure: In-Plane Flexure (see § 6.2.2.1), in-plane Tension-Flexure (see § 6.2.2.2), in-plane Compression-Flexure(see § 6.2.2.3);
- Shear (see § 6.2.3);
- Torsion (see § 6.2.4);
- In-Plane Flexure and Shear (see § 6.2.5).

(1) The usual presence of high resin concentration in the web-flange junctions (WFJ) of steel-like unidirectional pultruded profiles requires a careful investigation on their actual mechanical behaviour, which behave as deformable rather than as rigid. The actual constitutive law of this portion of the profiles is relevant, mainly respect to ULS for stability problems (Appendix E). Further, the highlighted issue may lead to the premature failure of the profiles due to interlaminar shear stresses. Both the aspects above should be carefully investigated by the manufacturers and the results made known to the user.

6.2.1 NORMAL FORCE

6.2.1.1 AXIAL TENSION

(1) In the case of structures subject to axial tensile load, the design value of the force, $N_{t,Sd}$, should satisfy the following condition:

$$N_{t,Sd} \leq N_{t,Rd} \quad (6.1)$$

In the relationship (6.1) the design resistance, $N_{t,Rd}$, takes the following values:

- (section without holes)

$$N_{t,Rd} = A \cdot f_{t,d}, \quad (6.2)$$

- (section with opening)

$$N_{t,Rd} = 0.9 \cdot A_{net} \cdot f_{t,d}, \quad (6.3)$$

where $f_{t,d}$ is the design strength of the material, A is the area of the section, and A_{net} is the net area of the section. The latter can be evaluated as follows in case of circular holes:

$$A_{net} = A - n \cdot t \cdot d \quad (6.4)$$

where the symbols n and d denote, respectively, the number and diameter of the holes present, while t denotes the thickness of the profile.

6.2.1.2 AXIAL COMPRESSION

- (1) In the case of elements subject to axial compressive load, the design value of the compressive force, $N_{c,Sd}$, corresponding to each of the transversal sections, should satisfy the condition:

$$N_{c,Sd} \leq N_{c,Rd} \quad (6.5)$$

In the relationship (6.5) the design resistance, $N_{c,Rd}$, can be obtained as follows:

$$N_{c,Rd} = \min\{N_{c,Rd1}, N_{c,Rd2}\}, \quad (6.6)$$

where $N_{c,Rd1}$ is the value of the compressive force of the profiled element and $N_{c,Rd2}$ the design compression value which causes the instability of the element.

The value of $N_{c,Rd1}$ can be calculated through the following expression:

$$N_{c,Rd1} = A \cdot f_{c,d} \quad (6.7)$$

where $f_{c,d}$ is the design compressive strength of the material.

The value of $N_{c,Rd2}$ can be determined either through numerical/analytical modelling (see § 5.2 (4)) or tests (see §5.5 (1)). In the former case, the analysis can be carried out by attributing the profile an initial imperfection.

(2) In the case of double symmetric profiles, the technical literature provides evaluations of $N_{c,Rd2}$ which take into account the interaction between local and global instability phenomena (see Annex C).

6.2.2 FLEXURE

6.2.2.1 IN-PLANE FLEXURE

(1) The structures subject to in-plane flexure should undergo both resistance and stability verifications. In the first case, in each transversal section, the design value of the bending moment, M_{Sd} , should satisfy the condition:

$$M_{Sd} \leq M_{Rd1} \quad (6.8)$$

In relationship (6.8) the design value of the flexural resistance of the profile, M_{Rd1} , is obtained from:

– section with no openings:

$$M_{Rd1} = \min\{W \cdot f_{t,d}, W \cdot f_{c,d}\}, \quad (6.9a)$$

– section with openings:

$$M_{Rd1} = 0.9 \cdot \min\{W_{net} \cdot f_{t,d}, W_{net} \cdot f_{c,d}\}, \quad (6.9b)$$

where W_{net} is the net section modulus, while $f_{t,d}$ and $f_{c,d}$ are the tensile and compressive design strengths of the material, respectively.

(2) In the case of beams under flexure on a symmetrical plane, subject to a constant bending moment, the verification of stability should require the satisfaction of the following condition:

$$M_{Sd} \leq M_{Rd2} \quad (6.10)$$

where the design value of the bending moment which causes the instability of the element, M_{Rd2} , can be determined either through numerical/analytical modelling (see § 5.2 (4)) or tests (see § 5.5 (1)). In the former case, the analysis can be carried out by attributing the profile an initial imperfection.

(3) In the case of beams subject to a variable bending moment along the axis, apart from a more rigorous evaluation, the verification of stability could be carried out assuming, in place of the stress moment, M_{Sd} , the equivalent moment:

$$M_{eq} = 1.3 M_m, \quad \text{with} \quad 0.75 M_{max} \leq M_{eq} \leq 1.0 M_{max}, \quad (6.11)$$

where M_m is the mean value of M_{Sd} along the axis and M_{max} its maximum value.

In the case of a shaft constrained at both ends and subject to a variable linear bending moment between the values of the ends M_a and M_b , the value of M_{eq} can be assumed as:

$$M_{eq} = 0.6 \cdot M_a - 0.4 \cdot M_b, \quad \text{with } |M_a| \geq |M_b|, \quad (6.12)$$

provided that $M_{eq} > 0.4 M_a$.



Figure 6.1 – Beam subject to a variable linear bending moment.

(4) In the case of profiles with a double symmetric section simply supported through flexure-torsional restraints and subject to a constant bending moment acting on the plane of maximum inertia of the section, the technical literature provides evaluations of M_{Rd2} which take into account the interaction between local and global instability phenomena. Such evaluations could be used (see Annex D).

(5) In order to verify the local instability of the flanges of double symmetric pultruded profile simply supported under flexure within the plane of minimum inertia, the design value of the critical bending moment could be evaluated either through numerical/analytical modelling (see § 5.2 (4)) or tests (see § 5.5 (1)). In particular, in the case of a constant bending moment, a 2-D model can be used limiting the study to the flange subject at the two extremities to a linear symmetrical distribution of normal stresses and constrained at the connection with the web. This constraint could be modelled as a rotational restraint of stiffness equal to the flexure-stiffness (transversal) of the web. A further delimitation of the critical load could be obtained assuming that the web represents a simple restraint for the flange.

6.2.2.2 COMBINATION OF BENDING AND AXIAL TENSILE FORCE

(1) In the case of profiles subjected to an axial tension load, $N_{t,Sd}$, as well as a constant bending moment, M_{Sd} , around one of the principal axes of inertia of the cross-section (Y or Z), in every transversal section the following condition should be satisfied for the ULS:

$$\frac{N_{t,Sd}}{N_{t,Rd}} + \frac{M_{Sd}}{M_{Rd1}} \leq 1, \quad (6.13)$$

where $N_{t,Rd}$ is the design tensile resisting force defined in § 6.2.1.1 and M_{Rd1} is the design resisting moment around the same principal axis of inertia, to be calculated through the expression (6.9).

(2) In addition to the aforementioned verification of resistance, stability should also be verified. In the absence of an exact evaluation of the critical load, it is possible to ignore tensile stresses and use the procedure for the case of flexure around the principal axes of inertia.

6.2.2.3 COMBINATION OF BENDING AND AXIAL COMPRESSION FORCE

(1) In the case of profiles subjected to an axial compression force, $N_{c,Sd}$, as well as a constant bending moment, M_{Sd} , acting around a principal axis of inertia of the cross-section (Y or Z), in every transversal section the following condition should be satisfied for the ULS:

$$\frac{N_{c,Sd}}{N_{c,Rd1}} + \frac{M_{Sd}}{M_{Rd1}} \leq 1, \quad (6.14)$$

where $N_{c,Rd}$ is the design compressive resisting force defined in § 6.2.1.2 and M_{Rd1} is the design resisting moment around the same principal axis of inertia, to be calculated through the expression (6.9).

(2) In addition to the aforementioned verification of resistance, stability should also be verified. In the absence of an exact evaluation of the critical load, this verification can be carried out through the following condition:

$$\frac{N_{c,Sd}}{N_{c,Rd2}} + \frac{M_{Sd}}{M_{Rd2} \cdot \left(1 - \frac{N_{c,Sd}}{N_{Eul}}\right)} \leq 1. \quad (6.15)$$

The symbols introduced in the relationship (6.15) have the following meaning:

- $N_{c,Rd2}$ represents the design value of the compressive force which causes the instability of the element;
- M_{Rd2} represents the design value of the bending moment which causes flexural instability;
- N_{Eul} represents the value of the Eulerian critical load.

The value of the Eulerian critical load, N_{Eul} , introduced in (6.15), is given by the following expression:

$$N_{Eul} = \frac{\eta_c}{\gamma_M} \cdot \frac{\pi^2 \cdot E \cdot I}{L_0^2}. \quad (6.16)$$

where L_0 and I are the buckling length and the moment of inertia around the considered principal axis, respectively, and E denotes the longitudinal elastic modulus of the profile.

(3) In the presence of a variable bending moment, the equivalent moment, M_{eq} , could be considered rather than the stressing moment, M_{Sd} , determined as described in § 6.2.2.1 (3).

6.2.3 SHEAR

(1) The design value of shear, V_{Sd} , for each cross section, should satisfy the condition:

$$V_{Sd} \leq V_{Rd} \cdot \quad (6.17)$$

In (6.17) the design resisting shear force, V_{Rd} , is obtained from:



$$V_{Rd} = \min\{V_{Rd1}, V_{Rd2}\} \cdot \quad (6.18)$$

The quantity V_{Rd1} can be obtained using the relation:

$$V_{Rd1} = A_v \cdot f_{V,Rd} \cdot \quad (6.19)$$

where $f_{V,Rd}$ is the design shear resistance of the material and A_v the area of the section resistant to shear given in Table 6.1 for the most widely used profiles.

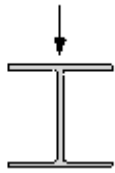
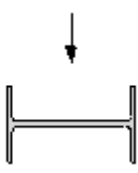
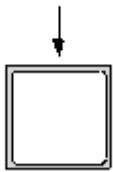
Table 6.1 – Area resistant to shear A_v for several thin pultruded profiles.

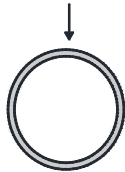
(a)	(b)	(c)	(d)	(e)	(f)
					
$b_w \cdot t_w$	$(2b_f \cdot t_f)/1,2$	$2b_w \cdot t_w$	$b_w \cdot t_w$	$(2b_f \cdot t_f)/1,2$	$\pi R \cdot t$

In Table 6.1, the symbols b and t denote the width and the thickness of the web (w) or the flange (f), respectively.

The design shear value which causes the local instability of the element, V_{Rd2} , could be determined from either numerical/analytical modelling (see § 5.2 (3)) or through tests (see § 5.5 (1)).

In the case of profiles with a plane section as reported in Table 6.1 (a, c, d), the value of V_{Rd2} could be determined through the expression:

$$V_{Rd2} = V_{loc,Rd} = A_v \cdot f_{V,loc,k} \cdot \quad (6.20)$$

In (6.20), $f_{V,loc,k}$ is the characteristic value of stress which determines the local instability of the web, assumed to be simply supported at the connection with flanges. The technical literature provides a closed-form expression of this value (see Annex E).

(2) Local verifications should be done on sections where concentrated loads are applied. In particular, it should be verified that:

$$f_{Sd,z} \leq f_{Tc,Rd} , \quad (6.21)$$

where $f_{Sd,z}$ is the design value of compressive stress acting in transversal direction (y or z) and $f_{Tc,Rd}$ is the corresponding design value of the compressive transverse strength.

In order to avoid local instability phenomena appropriate stiffening systems can be applied to the plane sections.

6.2.4 TORSION

(1) In the case of members that are subjected to torsion, the design value for torsional moment, T_{Sd} , in each cross section should satisfy:

$$\frac{T_{Sd}}{T_{Rd}} \leq 1 , \quad (6.22)$$

where the symbol T_{Rd} denotes the design value for resistance to torsion (torsional resistance moment) of the cross section.

The full torsional moment T_{Sd} in each cross section should be calculated as the sum of two internal effects:

$$T_{Sd} = T_{Sd}^{(SV)} + T_{Sd}^{(w)} , \quad (6.23)$$

where:

- $T_{Sd}^{(SV)}$ is the design value for the internal Saint-Venant's torsion;
- $T_{Sd}^{(w)}$ is the design value for the internal torsion with constrained warping.

(2) The following stresses caused by torsion should be taken into account:

- the shear stresses $\tau_{Sd}^{(SV)}$ due to the Saint-Venant's torsion $T_{Sd}^{(SV)}$;
- the normal (warping) stresses $\sigma_{Sd}^{(w)}$ due to bi-moment and the shear stresses $\tau_{Sd}^{(w)}$ due to torsion with constrained warping $T_{Sd}^{(w)}$.

(3) For a profile with a closed, box cross section, such as pipe profiles, it might be assumed for the sake of simplicity that the effects due to warping of the cross section are negligible.

(4) For the sake of simplicity, in the case of a profile with an open (not closed) cross section, such as I-profiles or H-profiles, it might also be assumed that the effects due to the Saint-Venant's torsion are negligible.

6.2.5 BENDING AND SHEAR

(1) The verification of profiles subjected to flexure around the principal axis of inertia, M_{Sd} , and shear, V_{Sd} , along the orthogonal axis, should be carried out to respect the following condition:

$$\left(\frac{M_{Sd}}{M_{Rd}}\right)^2 + \left(\frac{V_{Sd}}{V_{Rd}}\right)^2 \leq 1, \quad (6.24)$$

where V_{Rd} is defined in (6.18) and M_{Rd} corresponds to the minimum between the quantities M_{Rd1} and M_{Rd2} above.

6.3 ULTIMATE LIMIT STATES OF LAMINATED PLATES AND SHELLS

- (1) The verifications to be achieved concern both resistance (see 6.3.1) and stability (see 6.3.2).
- (2) One has to keep in mind that a composite plate has two main (and often different at ply levels) directions x and y , due to its usual anisotropy.
- (3) The most common case is that of balanced symmetric laminates with fibres lying along two orthogonal directions, x and y , to which this document only refers (see 3.1 (8)).

6.3.1 RESISTANCE VERIFICATIONS

- (1) The following two levels of verifications can be considered:
 - Ply level (see 6.3.1.1);
 - or
 - Laminate level (see 6.3.1.2).

6.3.1.1 PLY LEVEL

(1) In the verification at ply level (first ply failure), allowance should be made for the torque effects between stresses in different directions. The verification of resistance can be carried out by using the well know Tsai-Hill criterion. Consequently, in terms of stress components referred to the principal axes of the orthotropic ply, the following inequality should be satisfied:

$$\left(\frac{\sigma_{1,Sd}}{\sigma_{1,Rd}}\right)^2 + \left(\frac{\sigma_{2,Sd}}{\sigma_{2,Rd}}\right)^2 + \left(\frac{\tau_{12,Sd}}{\tau_{12,Rd}}\right)^2 - \frac{\sigma_{1,Sd} \cdot \sigma_{2,Sd}}{\sigma_{i,Rd}^2} \leq 1. \quad (6.25)$$

Generally, the design normal strengths, $\sigma_{i,Rd}$, are different for tension and compression. At the denominator of the mixed term in (6.25) the minimum value between the design normal strengths of the ply should be considered: usually, it corresponds to a compressive strength.

- (2) More sophisticated but widely used criteria exist, such as Tsai-Wu and Puck, taking into account differences between tension and compression could be used.

6.3.1.2 LAMINATE LEVEL

(1) When carrying out analyses at laminate level, the design value for the ultimate strength of the laminate as a should be used. Such a value can be obtained through iterative approaches by taking into account the progressive degradation of the stiffness of the layers due to the matrix cracks or micro cracks involved by the successive failure of the layers.

(2) For preliminary design of the balanced symmetric laminates, made of glass fibre reinforced thermoset polymers, the following design criterion should be used:

$$\varepsilon_{i,Sd} \leq \eta_c \cdot \frac{1.2}{\gamma_M} \quad \text{or} \quad \gamma_{ij,Sd} \leq \eta_c \cdot \frac{1.6}{\gamma_M} \quad , \quad (6.26)$$

where i, j denote the principal directions of orthotropy; ε_i denotes the linear strain corresponding to the axis i and γ_{ij} denotes the shear strain corresponding to the axes i, j .

- (3) A design by testing procedure should be adopted.

6.3.2 STABILITY VERIFICATIONS

(1) The stability of laminated plates and shells should be determined at laminate level.

(2) The stability of laminated plates and shells can be analysed either through numerical/analytical modelling (see § 5.2 (4)) or through experimental tests (see § 5.5 (1)).

(3) The technical literature provides the values of the critical loads in many situations of interest. Annex F provides some of these values for orthotropic symmetrical laminates with a length/width ratio greater than 5. The load conditions taken into account are: compression, shear, and pure bending. The Annex F also provides some interaction formulae useful for the stability verification of such kind of laminated plates subjected to combined loads: compression with shear, compression with bending, bending with shear.

6.4 ULTIMATE LIMIT STATES OF SANDWICH PANELS

(1) The following sandwich panel failure modes should be considered:

- Facing Failure (6.4.1);
- Transverse Shear Failure (6.4.2);
- Flexural Crushing of Core (6.4.3);
- Local Crushing of Core (6.4.4);
- General Buckling (6.4.5);

- Shear Crimping (6.4.6);
- Face Wrinkling (6.4.7);
- Intracell Buckling or Dimpling (6.4.8).

(2) In the following the symbols x and y denote the principal axes of orthotropy of the two faces, supposed to be balanced symmetric laminates with fibres lying along the two orthogonal directions x and y . The axis orthogonal to the face plane is denoted by z . The facings have the same principal axes of orthotropy. The principal axes of orthotropy coincide with the axes of moments. All the relations that are given are expressed in the coordinate system defined by the principal axes of orthotropy.

(3) Both principal directions have to satisfy the given failure criteria.

(4) The contribution of the core to the flexural and axial rigidity of the sandwich is considered to be sufficiently weak and it is neglected in the following (e.g. soft cores such as foams, honeycombs, balsa wood etc. but not solid wood or harder core).

(5) The maximum allowed strain for preliminary design is 1.2%.

(6) In the stability analysis of sandwich panels the effect of imperfections should be considered.

6.4.1 FACING FAILURE

(1) This mode of failure (Figure 6.2) may occur in either compression or tension face. It is caused by insufficient:

- panel thickness,
- facing thickness,
- facing strength.

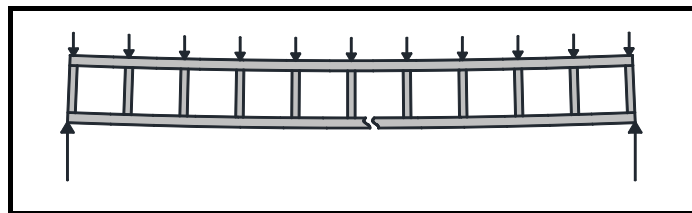

Figure 6.2 – Tensile facing failure.

(2) For symmetric sandwiches (identical faces) and if the contribution of the core to the flexural and axial rigidity of the sandwich is sufficiently weak (assumption (4) in §6.4) , then the factored ultimate axial stress in the face "i" is:

$$\sigma_{sd}^i = \frac{M_{sd}}{t_i h b} + \frac{N_{sd}}{2 b t_i}, \quad (6.27)$$

where M_{sd} is the factored ultimate bending moment, N_{sd} is the factored axial load, t_i is the thickness of the facing "i", b is the width of the sandwich and h is the distance from centre top facing to centre bottom facing.

- (3) The signs of both M_{sd} and N_{sd} have to be considered.
- (4) The design value of the stress capacity of the sandwich panel is obtained from:

$$\sigma_{sd}^i \leq f_{i,d} \text{ for } i=1,2 \quad (6.28)$$

where $f_{i,d}$ is the tensile or compressive design strength value of the facing "i".

- (5) The compressive value is often lower than the tensile one, and it should be taken into account in (6.28).

In the case of 2D panels, the condition (6.28) should be verified in both the principal directions of orthotropy, since for anisotropic faces $f_{i,d}$ can be very different in each direction.

In the case of non-symmetric sandwiches (different faces, different materials or different face thicknesses) expression (6.27) is no longer valid due to the change of the neutral axis induced by the asymmetry, and due to a new stress repartition at the faces. Moreover, the neutral axis, due to the anisotropy of the plies, is often different in the x and y direction. This new stress repartition has to be estimated by a more detailed analysis and should respect (6.28).

6.4.2 TRANSVERSE SHEAR FAILURE

- (1) This mode of failure (Figure 6.3) may occur for insufficient:
 - core shear strength,
 - or
 - panel thickness.

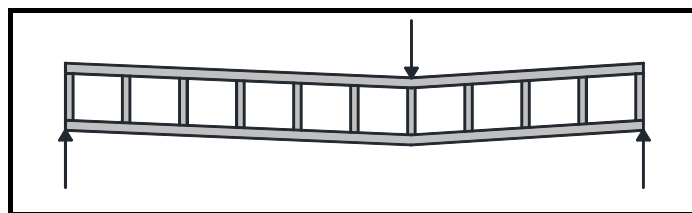

Figure 6.3 - Transverse shear failure.

- (2) In order to prevent this failure the factored ultimate shear, V_{sd} , should satisfy the condition:

$$V_{sd} \leq V_{Rd} \quad (6.29)$$

where the shear capacity V_{Rd} is given by:

$$V_{Rd} = f_{cv,d} \cdot b \cdot h, \quad (6.30)$$

with $f_{cv,d}$ being the design value of the core shear strength. The quantities b and h have the same meaning as in § 6.4.1 above.

6.4.3 FLEXURAL CRUSHING OF THE CORE

- (1) This mode of failure (Figure 6.4) is caused by:
- insufficient flatwise compressive strength,
 - or
 - excessive panel deflection.

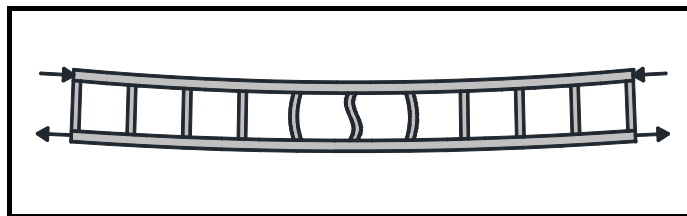

Figure 6.4 - Flexural crushing of the core.

- (2) Crushing of the core is a second order effect since the curvature has to be known in order to estimate the normal load induced by the moment on the core. Finite element can be used to estimate crushing.

6.4.4 LOCAL CRUSHING OF THE CORE

- (1) This mode of failure (Figure 6.5) is caused by low core compression strength.

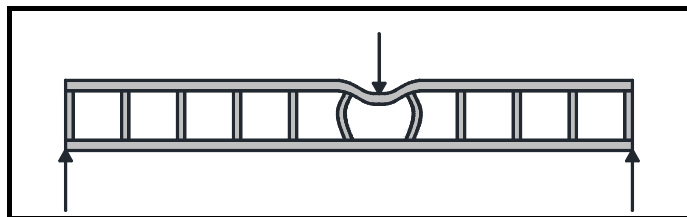

Figure 6.5 - Local crushing of the core.

- (2) The compressive stress in the core could be evaluated by modelling the loaded facing as a beam or a plate resting on an elastic foundation – the core – and subjected to axial and transverse forces. Mainly, local crushing can be caused by transverse forces distributed on small areas.

- (3) Practically, it should be avoided by applying the load over a sufficiently large area A_{cr} . The quantity A_{cr} can be roughly estimated as:

$$A_{cr} = P / f_{c,d}^{(core)} \quad (6.31)$$

where P is the loading and $f_{c,d}^{(core)}$ the factored compressive strength of core material.

(4) Another way to prevent such a local problem is the use of adapted insert between the faces. The performance of the system should be validated experimentally.

6.4.5 GLOBAL BUCKLING

(1) This mode of failure (Figure 6.6) is caused by:

- insufficient panel thickness,
- or
- insufficient core shear rigidity.

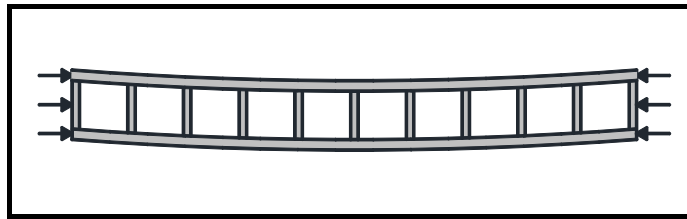

Figure 6.6 - Global buckling.

(2) As an approximated expression for the factored buckling load $P_{c,Rd}$ (likely different in x and y directions) of sandwiches with thin or thick faces (i.e. faces with bending stiffness) the following relation should be used:

$$P_{c,Rd} = \frac{P_{cb,Rd} \cdot P_{cs,Rd}}{P_{cb,Rd} + P_{cs,Rd}} \quad (6.32)$$

where:

- $P_{cb,Rd}$ represents the part of critical load due to bending:

$$P_{cb,Rd} = \frac{\eta_c}{\gamma_M} \cdot \frac{\pi^2 D}{(L_0)^2}; \quad (6.33)$$

- L_0 is the buckling length in the examined direction, which depends on the boundary conditions.
- D is the equivalent flexural rigidity and is calculated by taking into account the variation of the Young modulus along z -coordinates, and the position and moment of inertia of each ply, as done in the classical laminate theory. For a symmetric sandwich, D is calculated as follows:

$$D = \frac{E_f t_f^3}{6} + \frac{E_f t_f h^2}{2} + \frac{E_c t_c^3}{12} \quad (6.34)$$

where:

- E_f, t_f, E_c, t_c are respectively the equivalent Young modulus and thickness of faces and core.
- E_f can be measured on coupons in tension, or be estimated via the classical laminate theory.
- h is the distance from centre top facing to centre bottom facing.

For sandwich with thin faces $t_f \ll t_c$ and a weak core $E_f \gg E_c$, D from eq. (6.33) is approximated by:

$$D = \frac{E_f t_f h^2}{2}. \quad (6.35)$$

For sandwich with different faces the position of the neutral axis, d , has to be determined. Due to the potential anisotropy of faces, the neutral axis may be different in the x and y direction of the panel. The position of the neutral axis in direction x , is measured from the external skin of the bottom face, and is deduced from:

$$d(E_{f1}t_{f1} + E_{f2}t_{f2} + E_c t_c) = E_{f1} \left(\frac{t_{f1}^2}{2} + t_{f1}(t_{f2} + t_c)t_c \right) + E_{f2} \left(\frac{t_{f2}^2}{2} \right) + E_c \left(\frac{t_c^2}{2} + t_{f2}t_c \right) \quad (6.36)$$

with subscript 1 for upper face and 2 for bottom face. Then the equivalent flexural D rigidity is given by:

$$D = \frac{E_{f1}t_{f1}^3}{12} + \frac{E_{f2}t_{f2}^3}{12} + \frac{E_c t_c^3}{12} + E_{f1}t_{f1} \left(h + \frac{t_{f2}}{2} - d \right)^2 + E_{f2}t_{f2} \left(d - \frac{t_{f2}}{2} \right)^2 + E_c t_c \left(\frac{h + t_{f2}}{2} - d \right)^2. \quad (6.37)$$

$P_{cs,Rd}$ in (6.32) is the part of the critical load due to transverse shear forces and is taken equal to the factored shear stiffness S_d , defined as:

$$S_d = \frac{\eta_c}{\gamma_{M2}} \cdot \frac{Gh}{k}, \quad (6.38)$$

where:

- G is the global shear modulus;
- k is a suitable shear factor, which for homogeneous rectangular plates is equal to 6/5. For sandwiches k can be approximated by:

$$k = \frac{t_c}{h^2} \approx 1 \quad (6.39)$$

if the product of the shear stiffness by the thickness of the individual faces $G_f t_f$ is much higher than the product of the shear stiffness by the thickness of the core material $G_c t_c$. With G_f , and G_c being

the shear modulus of the faces and the core, respectively. For other situations, k can be calculated by other methods (e.g. energy balance or finite element method).

(3) Expression (6.38) does not take into account the effects of imperfections and should be used only for preliminary design.

6.4.6 SHEAR CRIMPING

(1) Sometimes this mode of failure (Figure 6.7) occurs following, and as a consequence of, general buckling. It is caused by:

- too thin faces,
- low core shear modulus,
- low adhesive shear strength.

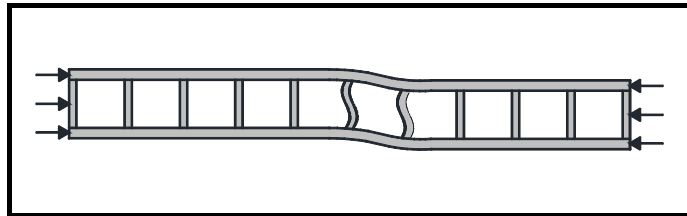

Figure 6.7 - Shear crimping.

(2) The critical loading leading to shear crimping is deduced from Eq. 6.32 with only $P_{cs,Rd}$ (no bending, only shear stress):

$$P_{cr,Rd} = P_{cs,Rd} \quad (6.40)$$

and consequently, shear crimping can be avoided if:

$$\sigma_{i,cd} < f_{i,cd} \quad i=1,2, \quad (6.41)$$

where $\sigma_{i,cd}$ is the factored compression state stress in the face "i" and $f_{i,cd}$ are the compression strengths of the same face.

(3) The verification 6.41 should be done in both x and y directions.

6.4.7 FACE WRINKLING

(1) If compressive stresses in faces reach a critical value, faces may buckle as a plate on an elastic foundation. It may buckle inward or outward, depending on adhesive strength in plane tension (Figure 6.8 a) and relative strength of core in compression (Figure 6.8 b).

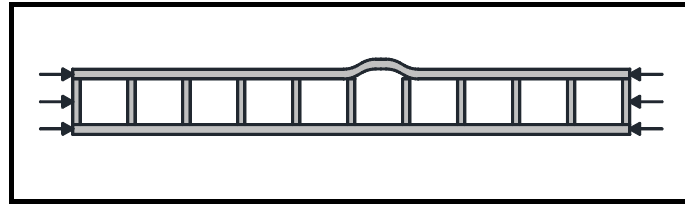

Figure 6.8a- Face wrinkling: adhesive bond failure.

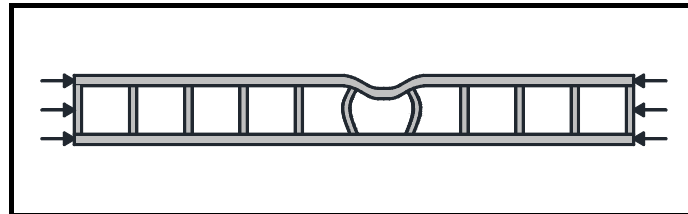

Figure 6.8b - Face wrinkling: core compression failure.

(2) In order to prevent this failure, the factored compressive stress, $\sigma_{wr,Rd}^{(i,\alpha)}$, in the direction α ($= x, y$) of the face "i" should be not higher than the following one:

$$\sigma_{wr,Rd}^{(i,\alpha)} = \min \left\{ 0.5 \frac{\eta_c}{\gamma_{M2}} \sqrt[3]{E_\alpha^{(i)} E_c G_c}, 0.82 \frac{\eta_c}{\gamma_{M2}} E_\alpha^{(i)} \sqrt{\frac{E_c t_f^{(i)}}{E_\alpha^{(i)} t_c}} \right\} \quad (6.42)$$

where $E_\alpha^{(i)}$ is the corresponding equivalent Young modulus of the face "i" in the direction α , E_c and G_c are the normal and shear moduli of the core, t_c and t_f the thicknesses of the core and of the faces.

6.4.8 INTRACELL BUCKLING

(1) This mode of failure, also known as dimpling, is applicable to cellular or corrugated core only. It occurs with:

- very thin facing,
- and
- large core cells.

It may cause failure by propagating across adjacent cells, thus inducing face wrinkling (Figure 6.9).

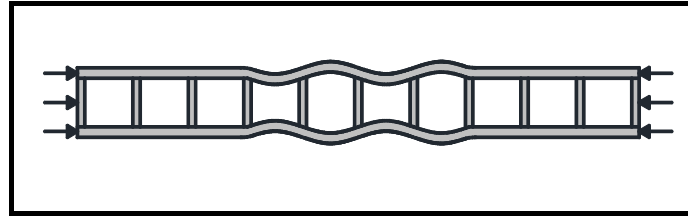

Figure 6.9 – Intracell buckling.

(2) In order to prevent this failure for cellular cores and in lack of more accurate analyses, the compressive stress in the facing should be no higher than the following one:

$$\sigma_{D,Rd}^{(i,\alpha)} = \frac{\eta_c}{\gamma_M} \cdot k \cdot \frac{E_\alpha^{(i)}}{\lambda_f} \cdot \left[\frac{t_f}{\Delta} \right]^2 \quad (6.43)$$

where $\sigma_{D,Rd}^{(i,\alpha)}$ is the factored critical dimpling stress in the α direction ($= x, y$) of the face “ i ”, $E_\alpha^{(i)}$ is the equivalent compressive Young modulus in the α direction of the face i , $\lambda_f = 1 - \nu_x \cdot \nu_y$ (ν_x and ν_y being the Poisson’s ratios in the directions x or y , respectively), t_f is the facing thickness. The quantity Δ is a characteristic cell size:

- for a square cell honeycomb, Δ is the length of the side of the cell and $k \approx 2.5$;
- for hexagonal cell honeycomb, Δ is the inscribed diameter of the cell and $k \approx 2$.

6.5 FATIGUE

6.5.1 GENERAL

(1) For structures subject to cyclic variations in the size of the load, and where the number of expected load cycles is expected to exceed 5000, while causing the peak stress from cyclic and permanent loads to exceed 15% of the material’s design strength, or where the absolute maximum value of the cyclic load is greater than 40 % of the fully factored load, fatigue should be taken into account.

(2) The service life of a structure subject to fatigue load is expressed by the number of load repetitions to failure. Fibre-dominated strength loss due to fatigue could be disregarded in the case of glass and carbon fibres. Generally speaking, resin-dominated strength loss cannot be disregarded.

(3) Fatigue damage occurs as a result of varying loads, regardless of the sign of the load. Fatigue damage leads to a loss of strength and stiffness and/or cracking and failure.

(4) A cyclic load might be regarded as a constant amplitude load provided that the difference between the maximum and minimum values of the load amplitude does not exceed 10 %. Above that figure, the fatigue load is regarded as a variable amplitude load.

(5) In the case of a constant amplitude load, the fatigue life should be determined using the $S-N$ line of the same material and of the fatigue load type under consideration, expressed as an R value.

(6) The R value should be calculated from:

$$R = \frac{\sigma_{\min}}{\sigma_{\max}}, \quad (6.44)$$

where:

- σ_{\min} is the minimum stress that occurs during a cycle;
- σ_{\max} is the maximum stress that occurs during a cycle.

(7) It is recommended to verify the fatigue performance for the occurring R -value.

(8) Alternatively when determining the service life at constant amplitude the following should apply:

- if the structure is only subject to varying tensile load, an $S-N$ diagram defined for $R = 0.1$ can be used;
- if the structure is subject to both tensile and compressive stresses, an $S-N$ diagram defined for $R = -1$ can be used;
- if the structure is only subject to varying compressive stresses, an $S-N$ diagram defined for $R = 10$ can be used.

Values of R near 1 are susceptible to cause creep effects.

(9) Variable amplitude loads may be considered as a combination of constant amplitude loads using Rainflow counting.

(10) When determining the service life for a fatigue load with a constant or variable amplitude load with an R value for which no $S-N$ line is known, the service life should be determined using a constant life diagram (CLD).

(11) The effects of variation of material properties and ageing should be accounted for in the tests, or by the use of partial factors and conversion factors in the determination of the fatigue life.

Annex H describes how to derive $S-N$ lines and the CLD diagram from test results.

6.5.2 FATIGUE RESISTANCE

(1) The evaluation of fatigue with a variable amplitude load should be based on Miner's linear damage rule:

$$D = \sum_i^M \frac{n_i}{N_i} \leq 1, \quad (6.45)$$

where:

- n_i is the number of cycles occurring in a load of a specific size and R value;

- N_i is the number of cycles to failure for a specific size and R value.
- (2) A component should be considered to have failed if damage D is equal to or larger than 1. The effect of the combined loads from the load spectrum is calculated while disregarding sequence effects.
- (3) If parts of the applied fatigue loading spectrum can cause cracking of the fibre mat-to-resin interfaces and other parts of the loading cause compression (and thus potential local buckling) of the fibre mats, then sequence effects can be important. These can be difficult to predict, so in such cases the designer might wish to consider tests such as suggested in §6.5.2.2 to determine the fatigue life of the component.
- (4) To determine the characteristic number of permissible load cycles N_i , in the $S-N$ diagram it is necessary to choose a service life that corresponds to a 10 % higher stress.
- (5) For the relationship between load repetitions and mean number of cycles to failure, the following equivalent double logarithmic equations could be used, where the parameters a and B are determined from linear regression derived from fatigue tests:

$$\log(N) = a \cdot \log\left(\frac{1.10 \cdot \gamma_M \cdot \sigma_{\max}}{\eta_c \cdot B}\right), \quad (6.46)$$

where:

- N is the number of cycles to failure;
- a is a regression parameter, to be determined from tests;
- σ_{\max} is the maximum cyclic stress occurring;
- B is the characteristic failure stress of the laminate at 1 cycle (y-intercept value).

With this formulation it is important that the size of the fatigue stress or strain should be clearly specified. For the cyclic fatigue stress, the maximum stress, the range or the amplitude (half the range) is generally taken.

Annex H describes how to derive an $S-N$ diagram from test results.

The B -value resembles but is not exactly equal to the static tensile strength ($R=0.1$ or tensile-tensile fatigue) or compressive strength of the laminate (for $R=-10$ or $R=-1$ or tensile-compression fatigue; compression-compression fatigue).

- (6) As a conservative assumption the $S-N$ line at $R=1$ could be used. In case of $R= -1$ the linear Goodman diagram may be used as a special case of the CLD (see Annex H).

6.5.2.1 MIXED-MODE FATIGUE LIFE PREDICTION

- (1) For complex geometries (for example at web-to-flange joints of cellular FRP bridge decks), mixed mode fatigue cracks might initiate and propagate at or near the fibre mat – to – resin interfaces due to co-existent local tensile stresses normal to the interface and shear stresses in the plane of the interface. This should be investigated.

(2) If the resin and mat material properties along with the local fibre mat geometries are known accurately, then the mixed mode fatigue life might be predictable using a finite element model in which the mat and resin are discretely represented.

6.5.2.2 COMPONENT FATIGUE TESTING FOR COMPLEX MIXED MODE EFFECTS

(1) If the local details are uncertain (e.g. if the fibre mat is of variable waviness), then confident prediction of local fatigue life can be difficult. In such cases, the designer might consider proof testing of the component (such as the cellular deck including the fatigue-critical joints of complex geometry) in fatigue, to produce $P-N$ curves (where P = load range and N = number of cycles to failure) for the component. In order to maximize the integrity of the results from such tests, care should be taken to reproduce the actual local contact load distribution on the component as far as possible.

6.6 REFERENCES

Ascione, L., Giordano, A., Spadea, S., Lateral buckling of pultruded FRP beams (2011). *Composites: Part B*, Vol. 42(4), pp. 819-824.

Bataineh, A. T., Ganga Rao, H. V. S., Failure Mode Analysis in Pultruded Fiber Reinforced Plastic Tension Members (2009). Report CFCWVU.

Borowicz, D.T., Bank, L.C., Behavior of Pultruded Fiber-Reinforced Polymer (FRP) Beams Subjected to Concentrated Loads in the Plane of the Web (2010). *ASCE Journal of Composites for Construction*.

Clapham, P., Canning, L., Asiedu K., The reconstruction of Moss Canal bridge, Rochdale, UK (2014). *Proc. ICE Bridge Engineering* (<http://dx.doi.org/10.1680/bren.12.00018>).

Cole, T.A., Lopez, M., Ziehl P.H., Fatigue behaviour and non-destructive evaluation of full-scale FRP honeycomb bridge specimen (2006). *ASCE J. Bridge Eng.* 11(4), pp. 420-429.

Colombi, P., Fava, G., Fatigue of tensile steel-CFRP joints (2012). *Composite Structures* 94(8), pp. 2407-2417.

Gay, D., HOA, Suong V., TSAI, Stephen W., (2002) *Composite materials: design and applications*. CRC press.

Hoff N. J., Mautner S.E., The Buckling of Sandwich-Type Panels, (1945). *Journal of the Aeronautical Sciences* (Institute of the Aeronautical Sciences), Vol. 12 (3), pp. 285-297.

Hadia, B.K., Matthews F.L., Development of Benson–Mayers theory on the wrinkling of anisotropic sandwich panels (2000). *Composite Structures*, Vol. 49 (4), pp. 425–434.

Karbhari, V.M., Durability of composites for civil and structural applications (2007). Woodhead Publishing Limited, pp. 126-147. ISBN 978-1-84569-035-9.

King, L., Toutanji, H., Vuddandam, R., Load and resistance factor design of fibre reinforced polymer bridge decks (2012). *Composites Part B: Engineering*, Vol. 43 (2), pp. 673-680.

Kinloch, A.J., Wang, Y., Williams, J.G., Yayla, P., The mixed mode delamination of fibre composite materials (1993). *Composites Science and Technology*, Vol. 47 (3), pp. 225-237.

Kollár, L.P., Buckling of Unidirectionally Loaded Composite Plates with One Free and One Rotationally restrained Unloaded Edge (2002). *Journal of Structural Engineering*, Vol. 128 (9), pp. 1202-1211.

Kollár, L.P., Local Buckling of Fiber Reinforced Plastic Composite Structural Members with Open and Closed Cross Sections (2003). *Journal of Structural Engineering*, Vol. 129 (11), pp. 1503-1513.

Manshadi, B.D., Vassilopoulos, A.P., De Castro, J., Keller, T., Contribution to shear wrinkling of GFRP webs in cell-core sandwiches (2011). *Journal of Composites for Construction*, 15 (5), pp. 833-840.

Manshadi, B.D., Vassilopoulos, A.P., De Castro, J., Keller, T., Modeling of buckling and wrinkling behavior in GFRP plate and sandwiches subjected to biaxial compression-tension loading (2011). *Journal of Composites for Construction*, Vol. 16 (4), pp. 477-487.

Mathieson, H., Fam, A., Static and fatigue behaviour of sandwich panels with GFRP skins and governed by soft-core shear failure (2014). *ASCE J. Comp. Constr.*, Vol. 18(2): [http://dx.doi.org/10.1061/\(ASCE\)CC.1943-5614.0000445](http://dx.doi.org/10.1061/(ASCE)CC.1943-5614.0000445).

McCarthy, M.J., Bank, L.C., Sensitivity Studies on Local Flange Buckling Equation for Pultruded Beams and Columns (2010). *Proceedings of CICE 2010, Beijing, China*.

Moon, D.Y., Zi, G., Lee, G.H., Kim, B.M., Huang, Y. K., Fatigue behaviour of a foam-filled GFRP bridge deck (2009). *Composites Part B: Engineering*, Vol. 40 (2), pp. 141-148.

Mosallam, A.S.,Elsadek A.A., Pul S., Semi-rigid behaviour of web-flange junctions of open-web pultruded composites. In: *Proceedings of International Conference on FRP composites 2009, San Francisco, California*.

Mottram, J. T., Determination of Critical Load for Flange Buckling in Concentrically Loaded Pultruded Columns (2004). *Composites, Part B: Engineering*, Vol. 35, No. 1, pp. 35-47.

Niu, K., Talreja, R., Modeling of Wrinkling in Sandwich Panels under Compression (1999). *J. Eng. Mech.*, 125(8), pp. 875–883.

Nguyen, D. T., D'Ottavio, >M., Caron, J.F., Bending analysis of laminated and sandwich lates using a layer-wise stress model (2013). *Composite Structures*, Vol. 96, pp. 135-142.

Nguyen, D.T., Chan, T.M., Mottram, J.T., Influence of boundary conditions and geometric imperfections on lateral-torsional buckling resistance of a pultruded FRP I-beam by FEA (2013). *Comp. Struct.*, Vol. 100, pp. 233–242.

- Osei-Antwi, M., De Castro, J., Vassilopoulos, A.P., Keller, T., FRP-balsa composite sandwich bridge deck with complex core assembly (2013). *Journal of Composites for Construction*, Vol. 17 (6).
- Qiao, P., Davalos, J.F., Barbero, E.J., Design optimization of fiber reinforced plastic composite shapes (1998). *Journal of Composite Materials*, Vol. 32 (2), pp. 177-196.
- Qiao, P., Davalos, J. F. and Wang, J., Local Buckling of Composite FRP Shapes by Discrete Plate Analysis (2001). *Journal of Structural Engineering*, Vol. 127 (3), pp. 245-255.
- Pagano, N.J., Stress fields in composite laminates (1978). *Int. J. Solids Struct.*, Vol. 14, pp. 385–400.
- Pascoe, J.A., Alderliesten, R.C., Benedictus, R., Methods for the prediction of fatigue delamination growth in composites and adhesive bonds – A critical review (2013). *Eng Fract Mech*, Vol. 112, pp. 72-96.
- Razzaq, Z., Prabhakaran, R., Sirjani, M. M., Load and Resistance Factor Design (LRFD) Approach for Reinforced-Plastic Channel Beam Buckling (1996). *Composites: Part B*, Vol. 27B, pp. 361-369.
- Roberts, T. M., Influence of Shear Deformation on Buckling of Pultruded Fiber reinforced Plastic I-profiles (2002). *Journal of Composites for Construction*, Vol. 6, pp. 241-248.
- Russo, A., Zuccarello, B., An Accurate Method to Predict the Stress Concentration in Composite Laminates with Circular Hole under Tensile Loading (2007). *Mechanics of Composite Materials*, Vol 43 (4).
- Sebastian, W.M., Ross, J., Keller, T., Luke, S., Load response due to local and global indeterminacies of FRP deck bridges (2012). *Composites Part B: Engineering*, Vol. 43(4), pp. 1727-1738.
- Sebastian, W.M., Keller, T., Ross, J., Influences of polymer concrete surfacing and localised load distribution on behaviour up to failure of an orthotropic FRP deck bridge deck (2013). *Composites Part B: Engineering*, Vol. 45(1), pp. 1234-1250.
- Sebastian, W.M., Webster, T., Kennedy, C., Ross, J., Profiled metal plate - cork mat loading systems on cellular FRP bridge decks to reproduce tyre-to-deck contact pressure distributions (2013). *J. Constr. Bld. Mat.*, Vol. 49, pp. 1064-1082.
- Tay, T.E., Williams, J.F., Jones, R., Characterisation of pure and mixed mode fracture in composite laminates (1987). *Theor Appl Fracture Mech.*, Vol. 7 (2), pp. 115-123.
- Timoshenko, S.P, Gere J.M, *Theory of elastic stability, 2nd Edition* (1961). McGrawHill, New York.
- Turvey, G.J., Structural analysis of CFRP-plated pultruded GRP beams (2006). *Structures and Buildings*, Vol, 159 (2), pp. 65-75.
- Waimer, F., Knippers, J., New design strategy for CFRP and concrete freeform structures (2013). *Advanced Composites in Construction 2013, ACIC 2013 - Conference Proceedings*, pp. 335-344.
- Vinson, J. R., *Sandwich structures* (2001). *Applied Mechanics Reviews*, Vol. 54 (3), pp. 201-214.

Zenkert D., *An Introduction to Sandwich Construction* (1995). Engineering Materials Advisory Services Limited.

Zureick, A., Scott D., Short-Term Behavior and Design of Fiber-Reinforced Polymeric Slender Members under Axial Compression (1997). *J. Composites for Const. ASCE*, Vol. 1 (4), pp.140-149.

Zureick, A., Steffen, R., Behavior and Design of Concentrically Loaded Pultruded Angle Struts. (2000). *J. Struct. Eng. ASCE*, Vol. 126 (3), pp. 406-416.

Zureick, A., Scott, D., Short term behavior and design of fiber reinforced polymeric slender members under axial compression (1997). *J. Composites for Construction ASCE*, Vol. 14, pp. 140-149.

Zureick, A., and Steffen, R. Behavior and Design of Concentrically Loaded Pultruded Angle Struts (2000). *ASCE Journal of Structural Engineering*, Vol. 126 (3), pp. 406-416.

7 SERVICEABILITY LIMIT STATES

7.1 GENERAL

- (1) It should be demonstrated that the structure will fulfil the criteria for the serviceability limit state (SLS) throughout its service life, including:
 - deformations which affect the outward appearance of the structure, the comfort of users and the functioning of the structure or cause damage to the finish and non-structural elements (see § 7.2);
 - vibrations which cause discomfort to users or reduce the function of the structure (see § 7.3). This includes the transmission of loads within the structure (e.g. transmission of vibrations in a floor);
 - damage that is likely to have an adverse effect on the outward appearance, durability or functioning of the structure (see § 7.4).
- (2) When calculating deformation and vibration behaviour, allowance should be made for effects on the stiffness of the material due to aging. The effect of creep should also be considered. The least favourable situation for the design should be assumed. If a lower stiffness is unfavourable, a reduced elasticity modulus should be assumed in the design by using the suggested conversion factor (see § 2.4.6).

7.2 DEFORMATIONS

- (1) Deformation should be determined using representative mechanical models. Allowance should be made for the effects of anisotropy and shear deformation.
- (2) In the case of slender structures, the second order effects should be taken into account, mainly regarding the consequences of initial imperfections (see § 5.2). They can induce unacceptable deformations even under service load levels.
- (3) Deformation might not be greater than that which can be matched by other adjoining elements, such as partition walls, glazing, cladding, fittings or finishes. In some cases a limit may be required to ensure the proper functioning of machines or equipment on the structure or to prevent water accumulation on flat roofs.
- (4) Deformations should be verified for all loading conditions.

7.2.1 DEFORMATION UNDER FREQUENT LOADS

- (1) Deformation under frequent loads might not negate the required clear space profile.

7.2.2 DEFORMATION UNDER INCIDENTAL LOADS

- (1) Deformation under occasionally occurring loads might not produce a limitation in use or a risk.

- (2) Greater deformations and vibrations might occur in FRP structures under occasional loads than is usual for structures made of steel, concrete or similar materials.

7.2.3 DEFORMATION UNDER QUASI-PERMANENT LOADS

- (1) Creep and relaxation should also be taken into account for quasi-permanent loads.

7.3 VIBRATION AND COMFORT

7.3.1 VIBRATION

- (1) Resonance should be taken into account in the design of FRP structures. The vibration behaviour should be verified in both the loaded and unloaded situation.
- (2) The natural frequency and the vibration behaviour should be determined in situations with and without aging effects.

7.3.2 COMFORT

- (1) EN 1990, Annex A and the national annex apply with respect to the comfort criteria for pedestrians.
- (2) Comfort should be determined in situations with and without aging effects.
- (3) When determining the response, a material damping value of 1.0 % and an average value of 1.5 % can be assumed as a realistic conservative lower limit for calculations. Higher damping values may be used if these have been substantiated by representative experimental data.

7.4 DAMAGE

- (1) Where the structure is expected to experience damage due to either proper or improper use, and the structure is required to remain functional after the damage has occurred, this damage should be taken into account in the verification.
- (2) When repairing damage the possible redistribution of stresses in the structure should be taken into account.

7.5 REFERENCES

Allen, D.E., Murray, T.M., Design criterion for vibrations due to walking (1993). Engineering J. AISC, Vol. 30 (4), pp. 117-129.

Ascione, F., Influence of initial geometric imperfections in the lateral buckling problem of thin-walled GFRP I-profiles, Composite Structures (2014), 112, pp. 85-99.

Chalk, P., Corotis, R.B., A probability model for design live loads (1980). J. Struct. Div. ASCE, Vol. 106 (10), pp. 2017-2030.

Ellingwood, B.R., Structural serviceability (1989). Engineering J. AISC, Vol. 26 (1), pp. 1-8.

Engdinez, M., Zureick, A.H., Deflection response of glass fiber-reinforced pultruded components in hot weather climates (2008). J. Composites for Const. ASCE, Vol. 12 (3), pp. 355-363.

Turkstra, C., Madsen, H., Load Combinations in Codified Structural Design (1980). J. Struct. Div. ASCE, Vol. 106 (12), pp. 2527-2543.

8 CONNECTIONS

8.1 GENERAL

- (1) Joints between structural elements can be bolted, riveted, bonded or a hybrid combination of these three methods of connection.
- (2) Effect of actions and stresses acting on the joints should be determined by elastic analysis of the structure or appropriate sub-structure.
- (3) Joints should have an adequate design resistance against the effect of actions that influence the structure over its intended service life.
- (4) Joint resistance should be determined by taking into account the resistances of each single joint element.
- (5) Verification of the joint resistance should be carried out by taking into account all the possible failure modes.
- (6) Verification of joint resistance should take into account the actual stress distribution and use the appropriate failure criterion.
- (7) If the joint failure leads to disproportionate collapse, design should be done by assuring the existence for an alternative stress path.

8.2 DESIGN CRITERIA

- (1) Joints should be designed so that:
 - the internal forces and moments are in static equilibrium with the design forces and design moments;
 - each element of the joint should be capable of resisting the design forces and design moments.
- (2) In the case of multi-bolted joints, the shear force on a single bolt cannot be evaluated by statics, as in the case of ductile metals where gross yielding occurs at ULS.
- (3) Bolted joints should be designed so that the x-axis of the members converges to a point.
- (4) Eccentricity of the actions should be taken into account when determining the design forces and moments within the joint.

8.3 BOLTED JOINTS

8.3.1 GENERAL

- (1) Bolts and nuts of structural grade steels are to be in accordance with EN 1993-1-8 and of structural grade stainless steel are to be in accordance with EN 1993-1-4.
- (2) Attention should be given to the deformability of FRP bolts. The required resistance of connections with FRP bolts should be confirmed by testing in accordance with the requirements of EN 1990 – Annex D.
- (3) Joints subjected to shear actions should have bolts with a constant diameter, d . When bolts of varying diameters are used the joints' resistance should be determined by testing in accordance with the requirements of EN 1990 – Annex D.
- (4) Diameter of the bolts should not be less than the thickness of the thinnest connected element and should be not greater than one and half times the thickness of the thinnest connected element.
- (5) Hole should be drilled (or reamed, not punched) to have diameter d_0 that allows the bolt of diameter d to pass through without force. The clearance distance between d_0 and d should not exceed the limit specified in Table 8.1.
- (6) Steel or stainless steel washers of diameter $> 2d$ and conforming to ISO 7093 should be inserted under the bolt head as well under the nut.
- (7) Joints should be designed on the assumption that bolt torque is not beneficial to resistance and that forces are transferred by bearing between connecting elements.
- (8) Bolt should not be over-tightened to prevent compressive crushing failure of the FRP material in the through-thickness direction.
- (9) Distances between the centres of the holes for p_1 (pitch spacing) and p_2 (gage spacing) should not be less than $4d$ (Figures 8.1 and 8.2). When bolts are staggered, the gage spacing, p_2 , and the stagger distance, L , should be taken from Table 8.1.
- (10) In the cases not examined here, a design by testing procedure should be required.

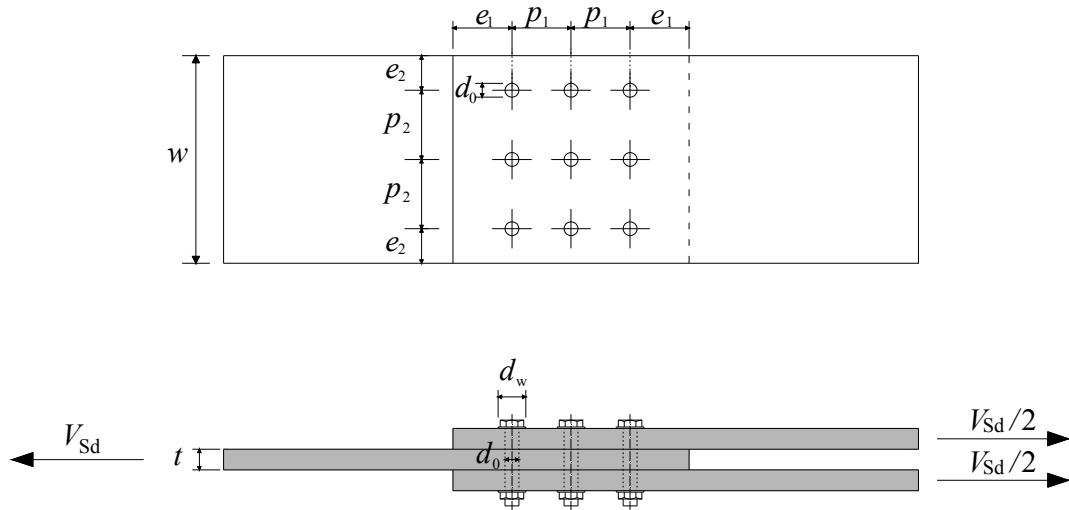

Figure 8.1 – Bolted Lap Joint (symbols for spacing of fasteners): not staggered bolts.

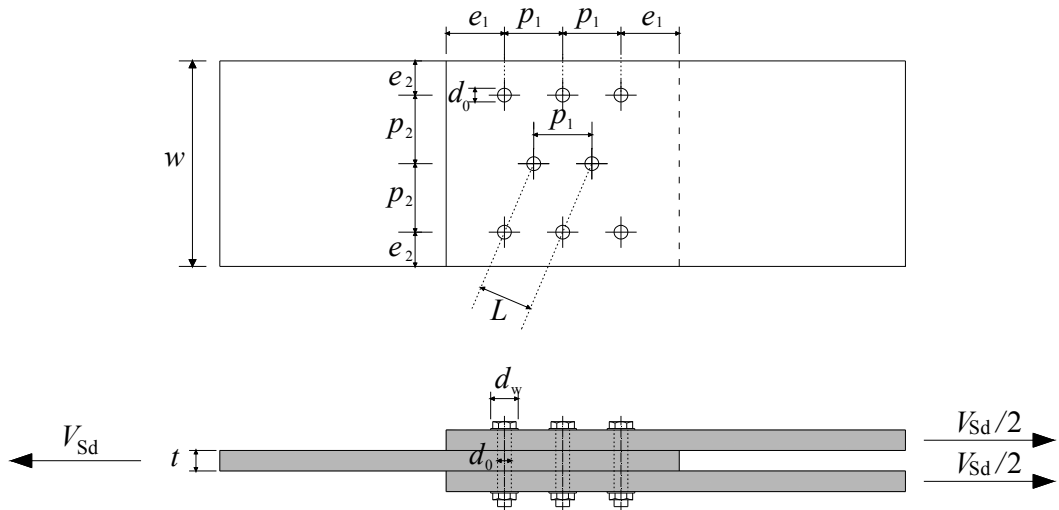

Figure 8.2 – Bolted Lap Joint (symbols for staggered fasteners): staggered bolts.

Figure 8.3 shows that for elements where $2e_2 > e_1$ the effective width w^* and the effective edge distance e_2^* should correspond to the smallest distance in any direction from the hole centre to an adjacent edge.

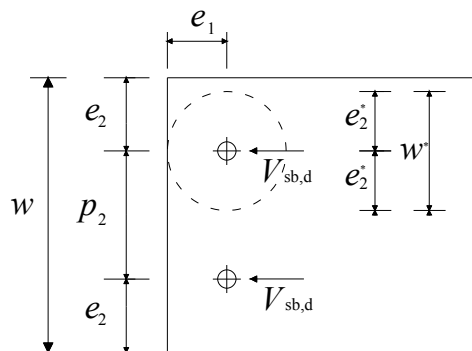

Figure 8.3 – Bolted Lap Joint with large width.

- (11) To avoid bolt-shear failure the minimum ratio e_1/d should be taken from Table 8.1.
- (12) Ratio e_2/d should not be less than half of the ratio p_2/d taken from Table 8.1.

Table 8.1 – Geometric limitations relative to a bolted joint.

Bolt diameter (recommended)	$d \geq t_{\min}$ $(t_{\min} \leq d \leq 1.5 t_{\min})$
Hole diameter (d_0)	$d \leq d_0 + 1 \text{ mm}$
Distances between holes	$P_1 \geq 4 d$ $P_2 \geq 4 d$ $L \geq 2.8 d$
Distances from edges	end $e_1 \geq 4 d$ side $e_2 \geq 2 d_b$

8.3.2 DESIGN CRITERIA

- (1) Static equilibrium should always be satisfied for the determination of the distribution of the:
- forces between the bolts in a connection;
 - stresses in the FRP material adjacent to the holes;
 - stress field distant from the influence of the holes.
- (2) For joints subjected to in-plane actions, the following distinct failure modes should be taken into account:
- net-tension;
 - pin-bearing;
 - shear-out;
 - bolt-shear.

When the number of bolt rows is two or higher, the mode of failure can be different. It can be assumed that the resistance formulae for the four distinct failure modes will capture the resistance when failure is by a non-distinct mode.

- (3) For bolted joints subjected to out-of-plane actions the failure modes that should be taken into account are:
- pull-out failure through the FRP element;
 - bolt failure in tension.
- (4) The verification of bolted joints subjected to shear and tension stresses should be carried out assuming a conservative failure criterion (see § 8.3.4.3).

8.3.3 BOLTED JOINTS SUBJECTED TO IN PLANE ACTIONS

(1) The following rule should be used in the absence of a more rigorous method or test results. It can be applied to design bolted joints in which at least one component in the joint is of FRP material. Assuming that each bolt row has the same type of bolts and number, n , up to a maximum number of four (Figures 8.1 and 8.2), and that each bolt in a row bears an equal part of the load resisted by that row, the force transmitted by each bolt, $V_{Sb,d}$, can be determined from:

$$V_{Sb,d} = \frac{V_{Sd} \cdot c_r}{n}, \quad (8.1)$$

$V_{Sd,d}$ is the design force acting in the plane of the joint and normal to the edge at distance e_1 from the nearest bolt row and the c_r row load distribution coefficient taken from Table 8.2.

For joints connecting FRP and elements of structural grade steels, the steel joint should be designed in accordance with clauses in EN 1993-1-1: 2005 and EN 1992-1-8:2005. Figure 8.4 shows as an example, that the first row of bolts for the FRP element is to be Row 4.

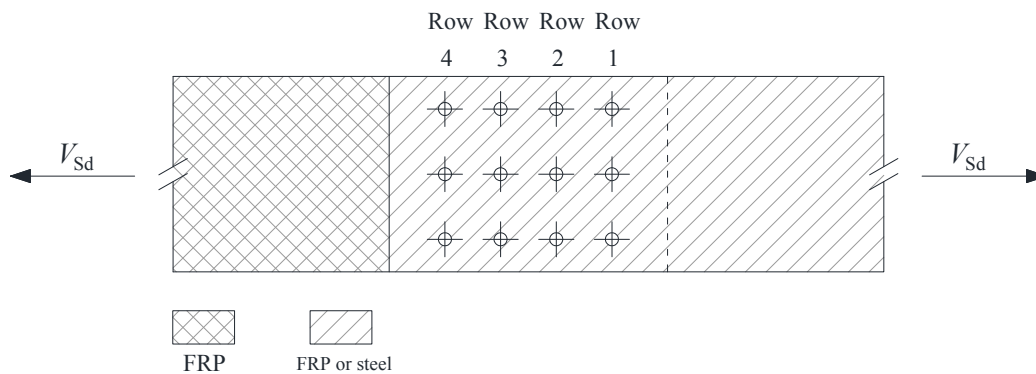

Figure 8.4 – Layout of a multi-bolted joint between two elements of which at least one of FRP material.

Table 8.2 – Load distribution coefficients, c_r , for each row of a multi-bolted joint.

Number of rows		Row 1	Row 2	Row 3	Row 4
1	FRP/FRP	1			
	FRP/steel	1			
2	FRP/FRP	0.5	0.5		
	FRP/steel	0.6	0.4		
3	FRP/FRP	0.4	0.2	0.4	
	FRP/steel	0.5	0.3	0.2	
4	FRP/FRP	0.3	0.2	0.2	0.3
	FRP/steel	0.4	0.3	0.2	0.1
> 4		Not recommended			

8.3.3.1 NET-TENSION FAILURE

(1) In case of pultruded elements and for the situation where V_{Sd} is oriented with angle $0^\circ \leq \theta \leq 5^\circ$ to the element axis (x axis, see Figure 1.4) the net-tension resistance is:

$$V_{Sd} \leq \frac{1}{k_{tc}} \cdot f_{Lt,Rd} \cdot (w - n \cdot d) \cdot t, \quad (8.2a)$$

n is number of bolts across the first bolt row where the net-tension failure occurs, t the element thickness and $f_{Lt,Rd}$ is the design strength for tensile material failure of the FRP material in the direction of the element axis.

For the situation where the force V_{Sd} is oriented with angle $5^\circ < \theta \leq 90^\circ$ to the element axis, the net-tension resistance is:

$$V_{Sd} \leq \frac{1}{k_{tc}} \cdot f_{Tt,Rd} \cdot (w - n \cdot d) \cdot t, \quad (8.2b)$$

$f_{Tt,Rd}$ is the tensile design strength of the FRP material in the direction orthogonal to the element axis, t is the thickness of the FRP layer and k_{tc} is a stress concentration factor. In lack of more precise evaluations, the coefficient k_{tc} should be assumed equal to 3.75 (Figure 8.5).

(2) In the case of a balanced symmetric laminate with fibres lying along two orthogonal direction (x and y , see Figure 1.3), the formulae 8.2a and 8.2b can be utilized assuming as θ the smallest angle between V_{Sd} and the direction x and y ($0^\circ \leq \theta \leq 45^\circ$): for $0^\circ \leq \theta \leq 5^\circ$ formula 8.2a should be used; for $5^\circ < \theta \leq 45^\circ$ formula 8.2b should be used.

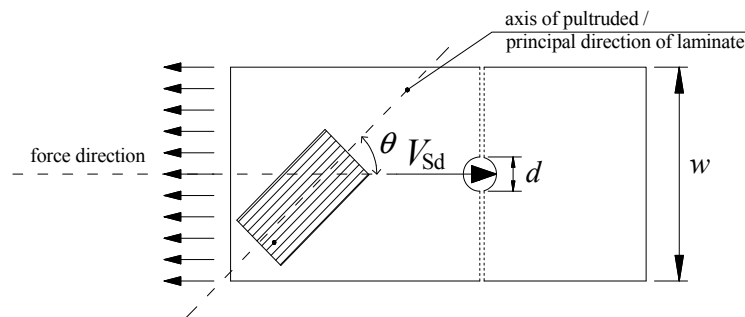

Figure 8.5 – Net-tension failure mechanism.

8.3.3.2 PIN-BEARING FAILURE

(1) In case of pultruded elements and for the situation where V_{Sd} is oriented with angle $0^\circ \leq \theta \leq 5^\circ$ to the element axis (x axis, see Figure 1.4), the pin-bearing resistance could be:

$$V_{Sb,d} \leq \frac{1}{k_{cc}} \cdot f_{L,br,Rd} \cdot d_b \cdot t . \quad (8.3a)$$

For the situation where the $V_{Sb,d}$ is oriented at an angle of $\theta > 5^\circ$ to 90° of the FRP material, the pin-bearing resistance could be:

$$V_{Sb,d} \leq \frac{1}{k_{cc}} \cdot f_{T,br,Rd} \cdot d_b \cdot t , \quad (8.3b)$$

$V_{Sb,d}$ is the bearing force transmitted per bolt, $f_{L,br,Rd}$ and $f_{T,br,Rd}$ are the design strengths for pin-bearing failure in the 0° and 90° directions, and k_{cc} is the factor equal to $(d_o/d)^2$ that accounts for the compressive stress concentration in front of the bolt from having a clearance hole (Figure 8.6).

(2) In the case of a balanced symmetric laminate with fibres lying along two orthogonal direction x and y , (see Figure 1.3), the formulae 8.3a and 8.3b can be utilized assuming as θ the smallest angle between V_{Sd} and the direction x and y ($0^\circ \leq \theta \leq 45^\circ$): for $0^\circ \leq \theta \leq 5^\circ$ formula 8.3a should be used; or $5^\circ < \theta \leq 45^\circ$ formula 8.3b should be used.

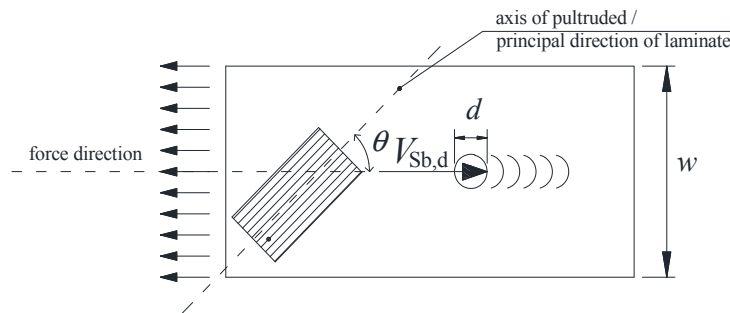

Figure 8.6 – Pin bearing failure mechanism.

8.3.3.3 SHEAR-OUT FAILURE

(1) Shear-out failure resistance should be determined from:

$$V_{Sb,d} \leq f_{V,Rd} \cdot (2e - d) \cdot t , \quad (8.4)$$

$f_{V,Rd}$ is the design shear strength of the FRP material (pultruded or laminated), and $V_{Sd,b}$ is the force transmitted by the bolt (Figure 8.7).

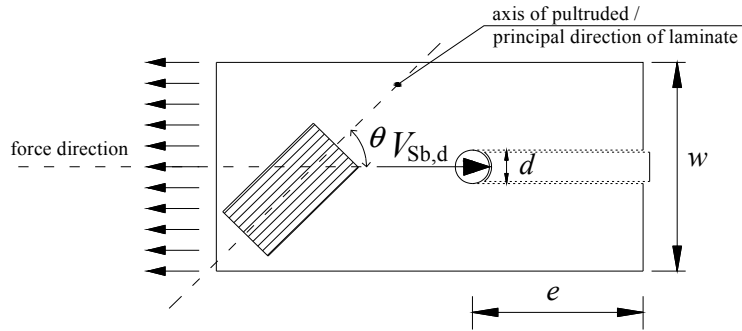

Figure 8.7 – Shear-out failure mechanism.

8.3.3.4 BOLT-SHEAR FAILURE

- (1) Shear resistance for a steel or stainless steel bolt should be designed in accordance with the clauses in EN 1993-1-8 or EN 1993-1-4.

8.3.4 BOLTED JOINTS SUBJECTED TO OUT OF PLANE ACTIONS

8.3.4.1 PULL-OUT FAILURE

- (1) Pull-out resistance (due to through-thickness shear failure) should be determined from:

$$N_{Sb,d} \leq f_{V,Rd} \cdot \pi \cdot d_r \cdot t, \quad (8.5)$$

where d_r is the diameter of the washer and $f_{V,Rd}$ represents the shear design strength of the FRP element in through-thickness direction (Figure 8.8).

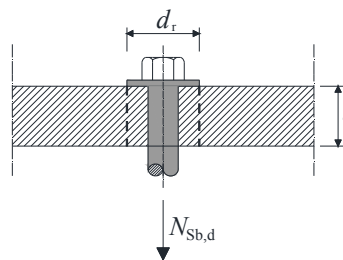

Figure 8.8 – Pull-out failure caused by through-thickness stresses.

8.3.4.2 BOLT FAILURE FROM TENSILE FORCES

- (1) Bolt failure from tensile force (Figure 8.9) should be designed in accordance with the clauses in EN 1993-1-8 or EN 1993-1-4.

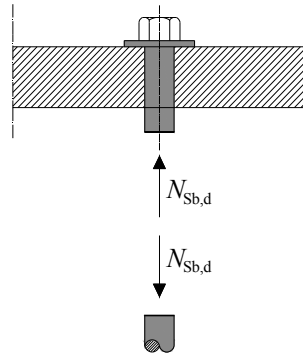

Figure 8.9 – Bolt failure due to tension forces.

8.3.5 BOLTED JOINTS SUBJECTED TO IN AND OUT OF PLANE ACTIONS

(1) In presence of combined shear and tensile actions resistance of the FRP material should be checked using a linear interaction failure criterion:

$$\frac{V_{Sb,d}}{R_{Vb,d}} + \frac{N_{Sb,d}}{R_{Nb,d}} \leq 1, \quad (8.6)$$

In Eq. (8.6) $V_{Sb,d}$ and $N_{Sb,d}$ are the shear and tension force in the bolt, while $R_{Vb,d}$ and $R_{Nb,d}$ represent the corresponding factored resistances (as for the one dimensional case) of the FRP material after accounting the presence of openings in the FRP material.

(2) In presence of combined shear and tensile actions the resistance of the bolting should be designed in accordance with the clauses in EN 1993-1-8 or EN 1993-1-4.

8.3.6 REFERENCES

Ascione, F., Feo, L., Maceri, F., An experimental investigation on the bearing failure load of glass fibre/epoxy laminates (2009). *Composites Part B: Engineering*, Vol. 40, pp. 197-205.

Ascione, F., Feo, L., Maceri, F., On the pin-bearing failure load of GFRP bolted laminates: An experimental analysis on the influence of bolt diameter (2010). *Composites Part B: Engineering*, Vol. 41, pp. 482-490.

Feo, L., Marra, G., Mosallam, A., Stress analysis of multi-bolted joints for FRP pultruded composite structures (2012). *Composite Structures*, Vol. 94 (7), pp. 3769-3780.

Evernden, M., Pelly, R. J., Single Bolt Tension Joints in Pultruded PFRP Legangle Connections (2009), *Proceedings Fourth International Conference on Advanced Composites in Construction (ACIC 2009)*, Net Composites, Chesterfield, UK, pp. 473-482.

McCarthy, M.A., McCarthy, C. T., Padhi, G. S., A Simple Method for Determining the Effects of Bolt-hole Clearance on Load Distribution in Single-column Multi-bolt Composite Joints (2006), *Composite Structures*, Vol. 73 (1), pp. 78-81.

Mottram, J. T., Turvey, G. J., Physical Test Data for the Appraisal of Design Procedures for Bolted Joints in Pultruded FRP Structural Shapes and Systems (2003). *Progress in Structural Engineering and Materials*, Vol. 5 (4), pp. 195-222.

Mottram, J. T., Determination of Pin-bearing Strength for the Design of Bolted Connections with Standard Pultruded Profiles (2009). *Proceedings Fourth International Conference on Advanced Composites in Construction, Net Composites*, Chesterfield, UK, pp. 483-495.

Mottram, J. T., Prediction of Net-tension Strength for Multi-row Bolted Connections of Pultruded Material using the Hart-Smith Semi-empirical Modeling Approach (2010). *Journal of Composites for Construction*, Vol. 14 (1), pp. 105-114.

Mottram J. T., Zafari, B., Pin-bearing strengths for design of bolted connections in pultruded structures (2011). *Structures and Buildings*, Vol. 164 (5), pp. 291–305.

Oppe, M., Zur Bemessung geschraubter Verbindungen von pultrudierten faserverstärkten Polymerprofilen (2009). *Schriftenreihe Stahlbau*, Heft 66, Shaker-Verlag Aachen, ISBN: 978-3-8322-8247-9

Oppe, M., Knippers, J., Behaviour of Bolted Connections in GFRP Subjected to Tension Loads (2009). *Proceedings Fourth International Conference on Advanced Composites in Construction (ACIC2009), Net Composites*, Chesterfield, UK, pp. 495-506.

Oppe, M., Knippers J., A consistent design concept for bolted connections in standardized GFRP-profiles (2010). *Proceedings of Fifth International Conference on FRP Composites in Civil Engineering – CICE2010*, Beijing, China, *Advances in FRP Composites in Civil Engineering – Vol. I FRP for Future Structures* - ISBN: 978-3-642-17486-5

Turvey, G. J., Wang, P., Thermal Preconditioning Study for Bolted Tension Joints in Pultruded GRP plate, (2007). *Composite Structures*, Vol. 77 (4), pp. 509-513.

Turvey, G. J., Wang, P., Failure of Pultruded GRP Single-bolt Tension Joints Under Hot-wet Conditions (2007). *Composite Structures*, Vol. 77 (4), pp. 514-520.

Turvey, G. J., Wang, P., Failure of Pultruded GRP Angle leg Junctions in Tension (2009). *Proceedings on Seventeenth International Conference on Composite Materials (ICCM-17)*.

Wang, Y. J., Bearing Behavior of Joints in Pultruded Composites (2002). *Journal of Composite Materials*, Vol. 36 (18), pp. 2199-2216.

8.4 ADHESIVE BONDED JOINTS

8.4.1 GENERAL

(1) Bonded connections should not be allowed for primary load bearing components, where failure of the connection could lead to progressive collapse or unacceptable risks. In these situations, their use is only allowed in combination with bolted or riveted connections or an alternative backup solution.

(2) The bonded joints taken into account in this document are made from FRP elements (adherents) subjected to axial force. The most common configurations are illustrated in Figure 8.10.

(3) The mechanical behaviour of joints c) and d) can be reduced to joints a) and b), respectively. On the basis of the large number of studies available in current literature, in the case a) the use of two adherents with the same thickness is recommended (simple-lap symmetrical joint).

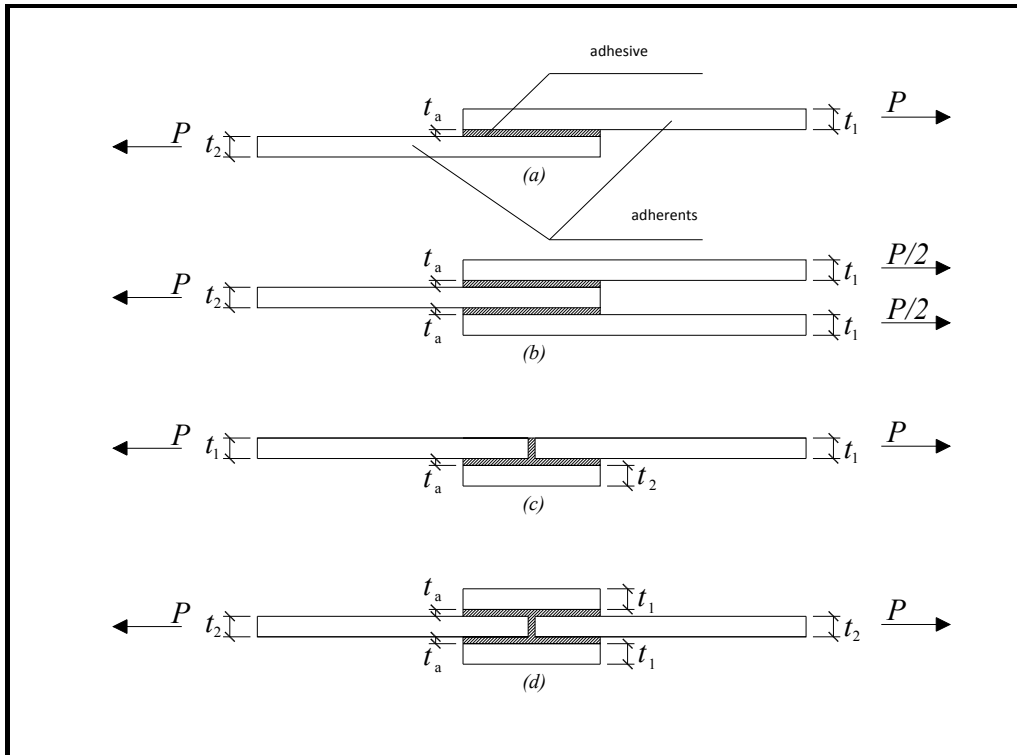

Figure 8.10 – Types of bonded joints: a) simple-lap; b) weighted double-lap; c) simple covered-joint; d) double covered-joint.

8.4.2 CONSTITUTIVE LAWS OF THE INTERFACE

(1) The layer of adhesive contrasts the relative displacements between the bonded elements (Figure 8.11): the transversal displacements, δ , which induce an opening between the adherents, and those in the longitudinal direction, s , which induce sliding.

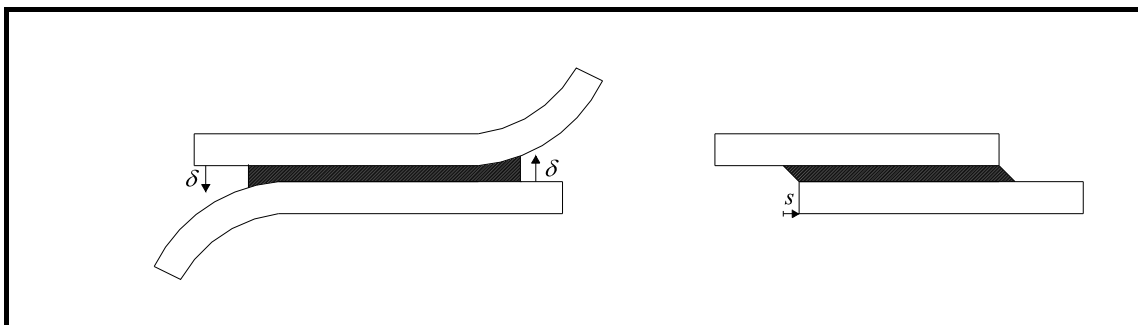

Figure 8.11 – Relative displacements between the adherents.

(2) By denoting σ and τ , respectively, the normal interfacial stress (orthogonal to plane of the joint) and the shear stress (parallel to the plane of the joint, along the direction of the axes of the joint), they could be defined by two uncoupled design cohesive laws, $\sigma(\delta)$ and $\tau(s)$ (Figure 8.12).

The displacement at the end of the linear range in both diagrams is generally much less than at the end of the “softening” range.

The subtended areas of the two diagrams are equal to the fracture energies for mode I (diagram $\sigma(\delta)$) and mode II (diagram $\tau(s)$), respectively.

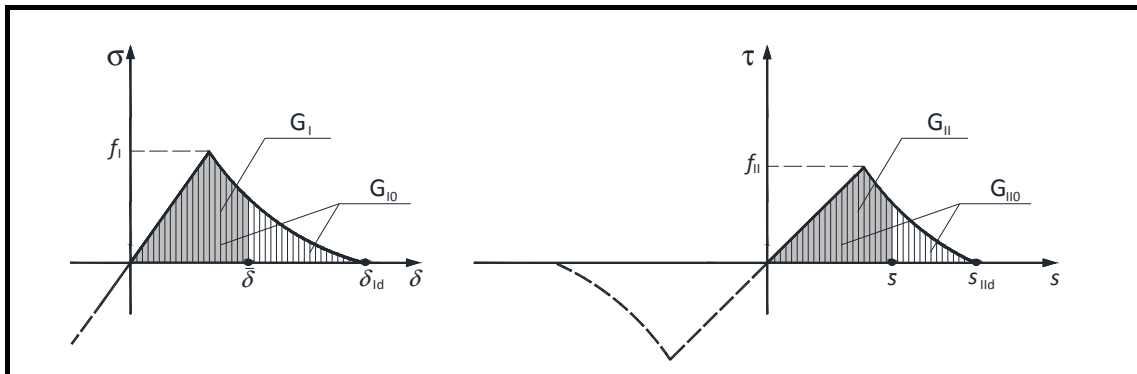

Figure 8.12 – Cohesive interfacial laws.

(3) Apart from more rigorous models, simplified constitutive interface laws could be used (Annex G).

8.4.3 INTERFACE FAILURE

8.4.3.1 FAILURE DUE TO DEBONDING OF THE JOINT

(1) If the adherents are subjected to external axial forces and the effects of flexure due to the eccentricity of the interfacial tangential, stresses from the axis of the adherents could be assumed as not relevant. That is the case with the usual forms of single-lap symmetrical joints as well as double-lap joints, and ultimate conditions are achieved according to mode II of failure (*sliding*).

8.4.3.2 FAILURE DUE TO DEBONDING AND OPENING OF THE JOINT

(1) If the joint is also subjected to shear and flexure, mixed mode I/II of failure occurs and the performance to transfer axial forces is penalized. The coupling between the normal and tangential stresses arising at the interface should be taken into account.

(2) In the case of single-lap symmetrical and double-lap joints, the aforementioned effects could be ignored.

(3) The value of axial resistance, N^*_{Rd} , can be calculated adopting a suitable mixed mode I/II of fracture, among those presented in current literature. These include the following relationship which could be easily applied due to its additive character:

$$\frac{G_I}{G_{I0}} + \frac{G_{II}}{G_{II0}} = 1. \quad (8.7)$$

In (8.7) the quantities G_I and G_{II} are, respectively, the areas subtended by the curves of Figure 8.12 over the ranges $[0, \bar{\delta}]$ and $[0, \bar{s}]$, where $\bar{\delta}$ and \bar{s} are, in that order, the design relative transversal and axial displacements; G_{I0} and G_{II0} are, respectively, the fracture energy for mode I: $G_{I0} = G_I(\bar{\delta} = \delta_{ld})$, and for mode II: $G_{II0} = G_{II}(\bar{s} = s_{ld})$.

8.4.4 ULTIMATE LIMIT STATE OF THE JOINT

(1) The verification of the ULS of a bonded joint should require that the following conditions are satisfied:

- within the *adherent*: the principal stresses associated to the stresses σ and τ transferred to the interface should be less than the design strength to tension and compression of the FRP matrix;
- in the *adhesive*:

$$N_{sd} \leq N_{Rd}, \quad (8.8)$$

where N_{sd} is related to the design normal strain which the joint should transfer and N_{Rd} related to the design normal strain resistance. N_{Rd} includes the effects of ageing and environmental effects, and is eventually penalized in order to take into account the presence of shear and flexure stresses.

(2) As an alternative to what has been previously stated, the strength of a bonded joint should be verified through appropriate tests (design by testing). These could represent a valid tool in the case of joints with particularly complex geometries. The design resistance can be determined in accordance to the procedure indicated in EN 1990.

8.4.5 PRACTICAL DESIGN REGULATIONS

- (1) The thickness of the adhesive layer, t_a , should not be less than 0.1 mm.
- (2) As a rule, the length of the bonding should not be less than:

$$L^* = \sqrt{\frac{\pi^2 \cdot t_{\max} \cdot E_{f\max}}{k_{II}}}, \quad (8.9)$$

where t_{\max} and $E_{f\max}$ are, respectively, the larger among the thicknesses of the adherents and the relative longitudinal elasticity moduli. In the case of shorter lap lengths, more accurate evaluations of the interface resistance are recommended, based on the constitutive interface laws presented in Figure 8.12.

8.4.6 BONDING CONTROL

- (1) Bonding control should be carried out through either destructive and/or non-destructive tests.

8.4.6.1 DESTRUCTIVE TESTS

- (1) In the case of joints realized either in a factory or on site, samples should be obtained and tested. At least 3 samples of each type of joint should be tested.

8.4.6.2 NONDESTRUCTIVE TESTS

- (1) Non-destructive tests could be used to characterize the homogeneity of the quality of the bonding, with the aim of highlighting any defects including delamination, debonding as well as the presence of empty voids. Tests include sonic and/or ultra-sonic tests, acoustic as well as thermographic emissions.

8.4.7 REFERENCES

Abdelaziz A.T., Boukhili R., Achiou S., Gordon S., Boukehili, H., Bonded joints with composite adherends. Part I. Effect of specimen configuration, adhesive thickness, spew fillet and adherend stiffness on fracture (2006). *Int J Adhes.*, Vol. 26, pp. 226–36.

Ascione, F., Mancusi, G., Curve adhesive joints (2012). *Compos Struct.* Vol. 94, pp. 2657–2664.

Ascione, F., Ultimate behaviour of adhesively bonded FRP lap joints (2009). *Composites Part B: Engineering*, Vol. 40, pp. 107-115.

Ascione, F., Mechanical behavior of FRP adhesive joints: A theoretical model (2009). *Composites Part B: Engineering*, Vol. 40, pp. 116-124.

da Silva, LFM, Adams RD., Joint strength predictions for adhesive joints to be used over a wide temperature range (2007). *Int J Adhes.*, Vol. 27, pp. 362–379.

Kafkalidis, MS., Thouless, MD., The effects of geometry and material properties on the fracture of single lap-shear joints (2002). *Int J Solids Struct.*, Vol. 31, pp. 2537–2563.

Katnam, KB., Sargent, JP., Crocombe, AD., Khoramishad, H., Ashcroft, IA., Characterisation of moisture-dependent cohesive zone properties for adhesively bonded joints (2010). *Eng Fract Mech.*, Vol. 77, pp. 3105–3119.

Keller, T., Vallée, T., Adhesively bonded lap joints from pultruded GFRP profiles. Part I: Stress-strain analysis and failure modes (2005). *Composites Part B: Engineering*, Vol. 36 (4), pp. 331-340.

Sato Chiaki, Stress estimation of joints having adherends with different curvatures bonded with viscoelastic adhesives (2011). *Int J Adhes Adhes*, Vol. 31, pp. 315–332.

Shahverdi, M., Vassilopoulos, A.P., Keller, T., Mixed-mode quasi-static failure criteria for adhesively-bonded pultruded GFRP joints (2014). *Composites Part A: Applied Science and Manufacturing*, Vol. 59, pp. 45-56.

9 PRODUCTION, REALIZATION, MANAGEMENT AND MAINTENANCE

9.1 GENERAL

- (1) The production and realization procedures of FRP structures should be described in an execution and quality plan.
- (2) The production should be executed by producers and personnel with appropriate level of experience for the used FRP materials and production techniques.
- (3) When determining the necessary level of experience, the complexity and consequence class of the structure should be taken into account.
- (4) The procedures involved in the assembly and installation of the FRP structure should be described in the execution plan.
- (5) The assembly and installation of an FRP structure should be executed under supervision of a professional with the required experience in working with FRP materials and FRP structures, in line with EN 1990. The executing personnel should be provided with clear instructions on working with FRP, before the start of the installation process.
- (6) The general inspection of an FRP structure should be executed by a well instructed expert, described in accordance with an included inspection plan. A detailed inspection should be executed periodically, in accordance with an in advance described pattern, and in case of ascertained deviations. Detailed inspections should be executed by an FRP expert.
- (7) In addition to the above described guidelines it could be stipulated than for important structures (e.g. consequence class 3 structures) an independent check by an FRP expert is executed.

9.2 QUALITY PLAN

- (1) Before the start of the production, the following aspects should be prepared:
 - A statement of the necessary characteristics and nominal properties of the FRP structure and materials.
 - A test plan, describing the tests that should be executed and FRP material samples that should be prepared. The test plan involves the tests that are part of the quality control procedures as well as tests that are part of the proof of performance of the design.
 - A quality plan of the production. This quality plan describes the materials, curing procedure, process control, end control.
- (2) The manufacturer should have a quality system in place in accordance with current ISO standards in which the following are described:
 - material control;
 - process control;
 - end control.

- (3) The producer should register the following information:
- materials used, including supplier data as well as health and safety information;
 - estimated weight of the main parts, assembled parts included;
 - report of the quality control
 - report of the executed design, product and process verifications and results;
 - report of the executed tests and test results, in accordance with § 11.2.

9.3 MATERIALS

- (1) The materials that are used should be traceable in accordance with NEN-EN16245.
- (2) Presence of moisture and dust should be prevented during the production of FRP. Fibre material and core materials should be free of dust and moisture.
- (3) Processing of the resin should be done at a temperature of at least 3 °C above the dew-point temperature of the resin and at a temperature in the workroom and tools that is within the operating temperature range as prescribed by the resin supplier.
- (4) Fibres, resin, adhesives and other chemical materials should be processed in accordance with the suppliers' regulations and may not be used beyond the expiry date.

9.4 PRODUCTION

- (1) As a minimum, the following parameters should be controlled and verified during the production of FRP parts:
- Temperature, moisture content and pressure during the process (impregnation and cure)
 - Number of plies and ply thickness or weight
 - Position of splices and overlap lengths
 - Fibre orientation and fibre alignment
 - Fibre tension (pultrusion and filament winding)
 - Fibre wetting
 - Void content
 - Fibre volume content
 - Barcol hardness
 - For sandwiches, complete adhesion between skins and core over the surface
- (2) FRP structural components should be cured in accordance with the specifications of the resin supplier. The cure temperature should be evaluated over the structure by measuring the temperature at predefined locations of the structure.
- (3) It should be verified that the required level of cure has been achieved by determining the T_g or HDT.
- (4) FRP profiles and shell structures should satisfy the quality requirements with respect to visual defects, equivalent to EN 13706-2, Table A.1.

9.4.1 GEOMETRIC TOLERANCES, IMPERFECTIONS AND DEVIATIONS IN FIBRE ALIGNMENT

- (1) In the final control of the FRP structure, the following should be verified as a minimum:
- geometrical dimensions and tolerances (deviations in dimensions, out-of-straightness and curvature);
 - material quality (imperfections);
 - coating (damage due to handling).

In case of deviations, the necessary measures should be defined with the designer or engineer.

- (2) Effects of crimp and creep should be taken into account
- (3) Profiles (whether or not pultruded) should meet the quality requirements with respect to geometrical imperfections equivalent to EN 13706-2, Table B.1.
- (4) The orientation and straightness of the fibres of continuous, non-random, glass fibre or HS-carbon fibre reinforcement, should not deviate with more than 1 degree from the orientation of the material on which basis the strength properties are determined.
- (5) In case of the use of IM and HM carbon fibres, the handling and the placing of the fibres should be done very securely to prevent the breaking of the fibre and to obtain a good fibre alignment. For IM and HM carbon fibre, the influence of the misalignment should be taken into account in the determination of the strength.

9.4.2 CONNECTIONS

- (1) To obtain an appropriate and aligned structure composed of profiles and bolted connections, the use of oversized bolt holes can be necessary. Starting from a hole diameter of at most 1.6 mm larger than the bolt diameter, the values in Table 9.1 could be used:

Table 9.1 - Tolerances for connections in structures built with FRP profiles.

Aspect	Value for tolerance
Cutting length	+ / - 3 mm
Squareness of the cut surfaces	+ 1 degree
Hole positions	+ / - 1.6 mm
Hole diameters until 12.7 mm	+ / - 0.4 mm
Hole diameters from 12.7 mm till 25.4 mm	+ / - 0.8 mm
Hole diameters bigger than 25.4 mm	+ / - 1.6 mm
Slots	+ / - 1.6 mm
In some situations it can be necessary to deviate from these values. This should be considered explicitly in the design and execution plan	

A narrower hole tolerance is favourable for the strength of the connection. The use of injection bolts or the realization of a bolt connection with bonded metal inserts could contribute to the realization of a slip free connection with a higher strength.

- (2) All edges should be sealed with a coating (e.g. topcoat, kit, resin or lacquer), to prevent penetration of moisture. This coating should be compatible with the resin of the laminate.

- (3) When drilling holes, FRP compatible tools should be used. During processing, FRP parts should be well supported to prevent cleaving, tearing and delamination.
- (4) Bolts should not be tightened too hard. No damage on the laminate is allowed. The use of torque controlled tools should be recommended.
- (5) Adhesive connections should be achieved in climate controlled conditions in accordance with application instructions from the adhesive supplier. The T_g of the adhesive should be verified based on material tests.
- (6) The surface of the adherents should be clean and free of moisture, fat and dust. In case of bonding, crucial parameters are surface preparation, humidity, temperature, thickness of the adhesive, as well as pressure and temperature during the cure process.
- (7) During surface preparation, mould release agents should be removed.
- (8) Overlap lengths and details of the adhesive connection should be specified in advance.
- (9) Adhesive connections should be executed by sufficiently instructed personnel under supervision of a sufficiently knowledgeable and experienced supervisor.

9.5 HANDLING AND STORAGE

- (1) During handling, concentrated loads should be avoided. Lifting of FRP parts is only allowed using prescribed methods and tool positions that are approved by the designer. In case of deviations, consequences should be assessed by the designer or an FRP expert.
- (2) During transportation and handling, damage caused by handling FRP parts should be prevented. During storage and transportation, parts should be kept separated. When lifting FRP parts, the use of protective materials is preferred.

9.6 INSTALLATION

- (1) Before starting the work, a detailed execution plan should be established by all parties, in consultation with the designer or a sufficiently experienced FRP engineer.
- (2) Installation of an FRP structure should be executed by sufficiently instructed personnel under supervision of a supervisor with the required level of experience and knowledge of FRP, in line with EN1990.
- (3) If before or during the installation unanticipated loads and attachment points are introduced, this should be assessed and approved by the designer.
- (4) After realization of a structure of components it should be verified whether the geometrical tolerances are met. In case of deviations, the necessary measures should be determined in communication with the designer.

9.7 USE

- (1) If during the using period unanticipated loads and attachment points occur, this should be approved by the designer.
- (2) The FRP structure should be inspected and maintained according to a predefined plan.

9.8 MAINTENANCE, INSPECTION AND REPAIR

- (1) The FRP structure should preferably be provided with a maintenance and inspection plan. This plan should make it possible to:
 - keep the structure in a serviceable state during its lifetime;
 - achieve good and responsible inspection.

An appropriate plan contains:

- Locations where the structure should be inspected (i.e. position and damage criteria) and assessment criteria, determined by the designer. This can eventually be extended with a detailed inspection plan, including descriptions of the inspection intervals and inspection procedures and inspection report format.
 - Restrictions during servicing, prepared by the engineer (for instance in cases when cleaning with high pressure is not allowed).
 - Restrictions in use, prepared by the supplier.
 - Complete overview of the realized structure with the used materials. This information should be provided, such that in case of damage of the structure, the repair can be done by a third party. This document is prepared by the supplier.
 - If needed, repair instructions can be added with respect to important components.
 - Instructions with respect to replacement of parts where relevant.
- (2) To evaluate the quality of a structure over its lifetime, it is recommended to execute a so called 0-measurement of the behaviour of the structure directly after installation.

9.8.1 MAINTENANCE

- (1) The maintenance of the FRP structure parts could consist of:
 - inspection (e.g. appearance and behaviour of the structure);
 - cleaning of the surfaces;
 - maintenance of connections (checking and tightening of bolts, maintenance of protective measures of adhesive connections);
 - repair of superficial damage of coating, kit layers and laminates;
 - repair of damage (for instance due to incidents, vandalism or fire);
 - repair and replacement of secondary parts or accessories with a shorter lifetime than the structure's lifetime (for instance wear layers).

- (2) It is advised to clean (coated) surfaces on a regular basis. This could be done by cleaning with water or special cleaners. For monolithic (non-sandwich) FRP structures, generally a high pressure washer could be used.
- (3) In case of surface damage on coatings and kit layers, it is advised to repair these.
- (4) Structural adhesive layers should be sealed from dirt and moisture.
- (5) Bolt connections which are applied with a torque wrench should be tightened after completion at least once. After this, they should regularly be inspected for tightness.

9.8.2 INSPECTION

- (1) Routine inspection is based on the following evaluations:
 - examination of defects such as discolorations and eventual local damage;
 - connections;
 - possible differences of environment occurring during the use of the structure.
- (2) More detailed inspection results from an evaluation of:
 - permanent deformations;
 - integrity of the structure;
 - behaviour of the structure, for instance related to a 0-measurement at completion.
- (3) Inspection that can be executed visually, whether or not supported by non-destructive techniques:
 - surface condition, discolorations, crazing, tears, blistering;
 - permanent deformations;
 - visible damage caused by vandalism or incidents;
 - tightness of connections;
 - cracking, delamination, damage to adhesive layers;
 - damage to insulation against galvanic corrosion.
- (4) Visual inspections can be supported by non-destructive techniques like:
 - (coin) tapping;
 - acoustic measurements;
 - infrared thermography;
 - laser shearography;
 - ultrasonic tests.

9.8.3 REPAIRS

- (1) In case of damage and defects of the FRP structure, the necessary repairs should be determined in consultation with a qualified designer, FRP engineer and/or FRP supplier.

- (2) In case of adhesive repairs, the same guidelines and conditions as prescribed for adhesive connections should apply.
- (3) Possible repair methods:
- creation of a bypass through the application of plates (bonded or mechanically connected);
 - filling with resin (in case of small superficial damages);
 - removing of the damaged FRP material and laminating of replacement FRP material;
 - laminating with FRP (strengthening).
- (4) During the design and execution of the repair, the remaining lifetime of the structure should be taken into account. Any repair operation should be provided with appropriate inspection instructions.
- (5) The repair should meet at least a level of confidence and reliability in conformity with adequate renovation standards.

10 ANNEX A (CONVERSION FACTOR $\eta_{cv,20}$)

(1) The following tables give the values of the conversion factor $\eta_{cv,20}$ for strength due to loading duration of 20 years.

Table 10.1 - Conversion factor $\eta_{cv,20}$ for strength due to loading duration of 20 years.

Type of material	$\eta_{cv,20}$					
Random laid laminate RLM	0,63					
Mixed laminate ML	$1/(2,0 - \delta)$					
Filament wound laminate FWL parallel to the direction of winding	$1/(1,8 - \delta)$					
Filament wound laminate FWL vertical to the direction of winding	FWL 1	FWL 2	FWL 3	FWL 4	FWL 5	FWL 6
	0,56	0,47	0,36	0,59	0,5	0,42
with $\varepsilon_z > 0,2\%$	0,42	0,34	0,26	0,48	0,38	0,36
Pultrusion profiles P parallel to the direction of pultrusion	$1/(1,8 - \delta)$					
Pultrusion profiles P vertical to the direction of pultrusion	0,53					
Pultrusion profiles P parallel to the direction of pultrusion with $\varepsilon_z > 0,2\%$	0,50					
Pultrusion profiles P vertical to the direction of pultrusion with $\varepsilon_z > 0,2\%$	0,33					

The quantity δ accounts for the mass portion of fibres, and ε_z is the strain in tension perpendicular to the winding direction.

Table 10.2 - Conversion factors $\eta_{cv,20}$ for strain and stiffness due to loading duration of 20 years (Terms RLM, ML and FWL according to Table 10.1).

Type of material	$\eta_{cv,20}$ for Elasticity and Strain					
Random laid laminate RLM	Cured			Not Cured		
	1/(2,4-2 δ)			1/(2,6-2 δ)		
Mixed laminate ML	Cured			Not Cured		
	1/(2,3-2 δ)			1/(2,5-2 δ)		
Filament wound laminate FWL parallel to the direction of winding	Normal force			Bending		
	1/(1,75- δ)			1/(1,85- δ)		
Filament wound laminate FWL vertical to the direction of winding	FWL 1	FWL 2	FWL 3	FWL 4	FWL 5	FWL 6
	1/(2,2- δ)	1/(2,45- δ)	1/(3,0- δ)	1/(2,15- δ)	1/(2,3- δ)	1/(3,2-2 δ)
with $\epsilon_z > 0,2\%$	1/(2,7- δ)	1/(3,1- δ)	1/(4,1- δ)	1/(2,6- δ)	1/(2,8- δ)	1/(4,0-2 δ)
Pultrusion profiles P parallel to the direction of pultrusion	Normal force			Bending		
	1/(1,75- δ)			1/(1,85- δ)		
Pultrusion profiles P vertical to the direction of pultrusion	Normal force			Bending		
	0,57			0,54		
Pultrusion profiles P vertical to the direction of pultrusion with $\epsilon_z > 0,2\%$	Normal force			Bending		
	0,5			0,4		

Table 10.3 - Definition of fibre lay-up for laminates RLM, ML and FWL.

Random laid laminate RLM						
Type	360-630 g/m ²					
fibre mass proportion						
Mixed laminate ML						
Type	ML1		ML2			
Lay-up	fibre mass proportion g/m ²					
RF xxxxxxx	450		450			
T +=+=+= *n	580		690			
RF xxxxxxx *n	450		450			
Filament wound laminate FWL						
type	FM1	FM2	FM3	FM4	FM5	FM6
Lay-up	fibre mass proportion g/m ²					
RF xxxxxxx	450	450	450	450	450	450
R // // // // // *n	120	240	480	120	240	480
RF xxxxxxx *n	300	300	300	450	450	450
R // // // // //	120	240	480	120	240	480
RF xxxxxxx	450	450	450	450	450	450
comments						
Random Fibres (RF)	xxxxxxx					
Roving (R)	// // // // //					
Textile (T)	+=+=+=					

11 ANNEX B (INDICATIVE VALUES OF FIBRES, RESINS, PLY AND LAMINATE PROPERTIES)

11.1 GENERAL

- (1) While characteristic values should be used in design calculations, indicative values can be used as reference or for an initial assessment of the feasibility of a specific design.
- (2) This Annex provides indicative values of fibres, resins, ply and laminate properties which are useful for preliminary design.

11.2 FIBRES

11.2.1 GENERAL

(1) Generally speaking, suppliers use different surface treatments on the fibres, so called 'sizings'. The sizing used affects the fibre-resin adhesion and is adapted to the specific resin type (for instance polyester resin or epoxy resin). Not every fibre available on the market is compatible with every type of resin. Glass fibres are supplied with a sizing suitable for polyester, vinyl ester or epoxy resins. In general, carbon fibre is produced with a sizing that is suitable for epoxy or vinyl ester resins. The use of fibres with a different resin than that for which the sizing is intended may result in significantly lower values of the main mechanical properties of a resulting ply or laminate. Table 11.1 shows indicative values of fibre properties, compared with some typical characteristic values of the same.

Table 11.1 – Typical values of fibre properties (characteristic and indicative values).

		Glass		Carbon		
		E glass	R glass	HS	IM	HM
		Characteristic values	Characteristic values	Characteristic values	Indicative values	Indicative values
Density (kg/m ³)		2570	2520	1790	1750	1880
Tension in fibre direction	Poisson's ratio ν_f	0.238	0.2	0.3	0.32	0.35
	Young modulus E_{f1} (MPa)	73100	86000	238000	350000	410000
	Strain limit ϵ_{f1} (%)	3.8	4	1.5	1.3	0.6
	Strength σ_{f1} (MPa)	2750	3450	3600	4500	4700
Tension perpendicular to fibre direction	Poisson's ratio ν_f	0.238	0.26	0.02	0.01	0.01
	Young modulus E_{f2} (MPa)	73100	86000	15000	10000	13800
	Strain limit ϵ_{f2} (%)	2.4	2.4	0.9	0.7	0.45
	Strength σ_{f2} (MPa)	1750	2000	135	70	60
Compression in fibre direction	Strain limit ϵ_{f1} (%)	2.4	2.4	0.9	0.6	0.45
	Strength σ_{f1} (MPa)	1750	2000	2140	2100	1850
Shear	Modulus G_f (MPa)	3000	34600	50000	35000	27000
	Strain limit γ_{f12} (%)	5.6	5.6	2.4	3	3.8
	Strength τ_{f12} (MPa)	1700	1950	1200	1100	1000
Thermal expansion	$\alpha (10^{-6} K^{-1})$	5 - 0	3	-0.4	-0.6	-0.5

(2) E glass is the most common type of glass. Other types of glass are available in addition to the glass types named above. The composition of the glass is designed to produce specific properties. S glass and S-2 glass for instance are high strength glass types, similar to R glass, but with different glass composition. The

fibre properties are similar to those of R glass, but are not identical. Another glass type is alkali-resistant (AR) glass, designed for use in combination with cement-based products. When carbon fibre is used, allowance should be made for the fact that, compared to glass fibre, carbon fibre is more sensitive to a load direction that differs from the fibre direction.

(3) In contrast to glass fibre, carbon fibre is orthotropic. The compression strength of carbon fibre is significantly lower than its tensile strength. Carbon fibres are more sensitive to loads from the axis of the fibre that can for instance occur due to deviations in the fibre orientation, in connection to the production of FRP parts.

(4) Aramid fibres are extremely well suited for resisting tensile forces and for energy absorption, but less well suited to absorbing compression loads.

11.3 RESIN

11.3.1 GENERAL

(1) The resin used should be appropriate to the surface treatment ('sizing') of the fibre.

(2) The choice of resin should be appropriate to the required properties, such as glass transition temperature, chemical resistance, fire reaction properties (e.g., flammability, heat release, smoke production) and electrical conductivity.

(3) Additives and fillers may be added to the resin to give it specific properties. The effect of additives and fillers on the mechanical properties should be taken into account. Examples include modifications in fire reaction properties, electrical conductivity and UV resistance. If the concentration of fillers is too high, this can have a negative effect on the resin properties, such as strength, stiffness, viscosity, glass transition temperature and durability. It is recommended to discuss the quantity and effect of additives and fillers with the resin supplier.

11.3.2 THERMOSET RESINS

(1) Indicative values of thermoset resins properties are given in Table 11.2.

Table 11.2 – Indicative values of thermoset resins properties.

	Polyester	Vinyl ester	Epoxy
Density	1.2	1.1	1.25
Poisson's ratio ($\nu_{12, \text{resin}}$)	0.38	0.26	0.39
T_g (°C)	approx. 60 ⁽¹⁾	approx. 100 ⁽¹⁾	80 - 150 ⁽¹⁾
Tensile or compression strength (MPa)	55 ⁽²⁾	75 ⁽²⁾	75 ⁽²⁾
Young modulus in tension (MPa)	3550	3350	3100
Strain limit in tension or compression (%)	1.8	2.2	2.5
In-plane shear modulus (MPa)	1350	1400	1500
Shear strength (MPa)	approx. 50	approx. 65	approx. 80
Shear strain limit (%)	3.8	3.7	5
Expansion coefficient (10^{-6} K^{-1}) ⁽³⁾	50 - 120	50 - 75	45 - 65
⁽¹⁾ The actual value of T_g depends on the polymerisation process applied and in particular on the temperature applied during post-curing. ⁽²⁾ There is a large variation in strength properties within every resin type. It should be verified during the production phase whether the resin used has the above properties as a minimum. The influence of the resin on fibre-dominated properties is limited. Deviating resin properties mainly affect resin-dominated properties such as ILSS, compression strength, shear strength and delamination. ⁽³⁾ The thermal properties of resin may vary widely depending on a precise composition. If thermal expansion is key to the design it is recommended that the analysis be based on test values.			

11.4 FILLERS AND ADDITIVES

- (1) The influence of fillers and additives on the material properties should be included in the calculation.
- (2) Additives are added for various reasons, such as in order to influence the processing properties, to improve specific material properties (such as fire reaction properties), or to reduce costs.
- (3) It is recommended that the minimum required or maximum recommended quantity of fillers or additive is established in consultation with the supplier.

11.5 CORE MATERIALS

- (1) For core materials, design data based on tests as detailed in Table 3.1 should be used in the design.
- (2) Natural core materials, such as balsa wood, have a larger distribution in the variation of material properties due to variations in material density, when compared to foam core materials or honeycomb cores.
- (3) Frequently used core materials include rigid foam (PUR, PS, PVC, PET, and PMI), balsa wood and various types of honeycomb cores (aluminium, Nomex, PP, PET).
- (4) Indicative values for the typical properties of a number of core materials are given in Table 11.3.

Table 11.3 - Indicative values for the typical values of foam core material properties.

	Density [kg/m ³]	Compression strength [N/mm ²]	Shear strength [N/mm ²]	Elasticity modulus [N/mm ²]	In-plane shear modulus [N/mm ²]
	Indicative values	Indicative values	Indicative values	Indicative values	Indicative values
PUR	50	0.3 - 0.5	approx. 0.2	6 - 10	4 - 5
	100	0.6 - 1.0	0.3 - 0.5	approx. 30	approx. 10
PVC Cross linked	40	0.5 - 0.8	0.3 - 0.4	20 - 30	approx. 10
	80	1.2 - 2.0	0.7 - 1.0	60 - 90	20 - 30
Linear	80	approx. 0.9	0.5 - 1.0	approx. 50	20
PMI	30	approx. 0.5	approx. 0.3	approx. 30	approx. 15
	70	approx. 1.5	approx. 1.0	approx. 90	approx. 30

(5) Climatic influences and long-term effects should be taken into account in the design. The conversion factors for fibre-reinforced polymers do not apply to core materials. Climatic influences and long-term effects should be defined on the basis of the core material behaviour.

(6) The document BÜV-Empfehlung, Tragende Kunststoffbauteile im Bauwesen [TKB], 2010, shows indicative values for the influence of temperature and aging on PUR foam. The anticipated aging effects of core materials are limited if there is a proper seal, and provided that the laminate quality of the sandwich skins is good. The influence of temperature on foam cores depends to a large extent on the type of polymer and may be significant. Generally speaking, the influence of temperature at service temperatures of < 40 °C is limited (in the order of 10 %).

(7) When lightweight foam core materials are used, their low strength and robustness means there is a significant risk at the bonding interface between the sandwich skins and the core. In situations where PUR foam is to play a long-term structural role, it is recommended that a material with a density of at least 50 kg/m³ is used, due to the brittleness of the material and its low strength.

11.6 PLY PROPERTIES

11.6.1 GENERAL

(1) Plies should be classified on the basis of the orientation of the fibre reinforcement. A distinction is made between:

- unidirectional plies (UD roving, UD tapes, UD non-crimp fabric);
- bi-directional plies (woven roving WR, woven fabric, woven cloth, stitched fabric);
- mat plies (discontinuous or chopped strand mat (CSM), continuous fibre mat and spray roving).

(2) Characteristic ply properties with a 5 % risk of being exceeded or underestimated should be used in the calculations. This in accordance with EN 1990, appendix D.

(3) Ply properties should be defined in conformity with the procedures described in Table 3.1. In the case of laminates that fulfil the following conditions:

- a fibre volume content of at least 15 %
- a thermoset matrix of unsaturated polyester, vinyl ester or epoxy resins,

the procedures and formulas in the sections below may be used for preliminary design.

(4) Halpin-Tsai formulas (UD ply and bi-directional plies) or Manera's formulas (mat plies) are used in the procedures described.

(5) Fibre-dominated properties of FRP are generally easy to predict. Resin-dominated strength properties are more susceptible to imperfections and processing conditions. The purpose of the minimum specified amount of fibre reinforcement in the principal directions is to make the in-plane material behaviour of the laminate sufficiently fibre-dominated. Resin-dominated mechanical strength properties include compression strength, compression and tensile strength transverse to the fibre, shear strength, and ILSS delamination properties.

11.6.2 INDICATIVE VALUES FOR PLY STIFFNESS PROPERTIES

11.6.2.1 UD PLYS

(1) The (mean) stiffness properties of UD plies can be calculated from:

$$E_1 = [E_R + (E_{F1} - E_R) \cdot V_f] \cdot \varphi_{UD} \quad (11.1)$$

$$E_2 = \left[\frac{(1 + \xi_2 \eta_2 V_f)}{(1 - \eta_2 V_f)} \cdot E_R \right] \cdot \varphi_{UD} \quad (11.2)$$

$$G_{12} = \left[\frac{(1 + \xi_G \eta_G V_f)}{(1 - \eta_G V_f)} \cdot G_R \right] \cdot \varphi_{UD} \quad (11.3)$$

$$\nu_{12} = \nu_R - (\nu_R - \nu_f) \cdot V_f \quad (11.4)$$

where:

with E_2 : $\eta_2 = \frac{\left(\frac{E_{f2}}{E_R} - 1 \right)}{\left(\frac{E_{f2}}{E_R} + \xi_2 \right)}$, $\xi_2 = 2$; with G_{12} : $\eta_G = \frac{\left(\frac{G_f}{G_R} - 1 \right)}{\left(\frac{G_f}{G_R} + \xi_G \right)}$, $\xi_G = 1$.

The formulas are derived from the semi-empirical Halpin and Tsai equations, where an additional empirical reduction factor $\varphi_{UD} = 0.97$ has been applied.

(2) For a UD ply on a base of E glass with unsaturated polyester, the typical values given in Table 11.4 can be used.

Table 11.4 - Indicative UD ply E glass stiffness values

V_f	E_1 [GPa]	E_2 [GPa]	G_{12} [GPa]	ν_{12}
40 %	30.4	8.9	2.7	0.30
45 %	33.8	10.1	3.0	0.29
50 %	37.2	11.4	3.4	0.29
55 %	40.5	12.9	3.8	0.28
60 %	43.9	14.6	4.3	0.27
65 %	47.3	16.8	5.0	0.27
70 %	50.7	19.4	5.8	0.26

11.6.2.2 BI-DIRECTIONAL PLIES

(1) The (mean) stiffness properties of balanced bi-directional plies (0/90 orientation) can be calculated from:

$$E_1 = E_2 = \frac{1}{2} \cdot \left[E_R + (E_{F1} - E_R) \cdot V_f + E_R \cdot \frac{(1 + \xi_1 \eta_1 V_f)}{(1 - \eta_1 V_f)} \right] \cdot \varphi_{0/90} \quad (11.5)$$

$$G_{12} = \left[\frac{(1 + \xi_G \eta_G V_f)}{(1 - \eta_G V_f)} \cdot G_R \right] \cdot \varphi_{0/90} \quad (11.6)$$

$$\nu_{12} = \left[\nu_R - (\nu_R - \nu_F) \cdot V_f \right] \cdot \frac{1}{2} \cdot \left[1 + E_R \cdot \frac{(1 + \xi_1 \eta_1 V_f)}{E_R + (E_{F1} - E_R) \cdot V_f} \right] \cdot \varphi_{0/90} \quad (11.7)$$

where:

with E_1 , E_2 and ν_{12} : $\eta_1 = \frac{\left(\frac{E_{f1}}{E_R} - 1 \right)}{\left(\frac{E_{f1}}{E_R} + \xi_1 \right)}$, $\xi_1 = 2$; with G_{12} : $\eta_G = \frac{\left(\frac{G_f}{G_R} - 1 \right)}{\left(\frac{G_f}{G_R} + \xi_G \right)}$, $\xi_G = 1$.

The formulas are derived from the semi-empirical Halpin and Tsai equations, where an additional empirical reduction factor $\varphi_{0/90} = 0.93$ has been applied due to the influence of imperfections.

(2) For a balanced bi-directional ply based on E glass with polyester resin, the typical values given in Table 11.5 can be used.

Table 11.5 – Indicative balanced bi-directional ply E glass stiffness values.

V_f	E_1 [GPa]	E_2 [GPa]	G_{12} [GPa]	ν_{12}
25 %	12.8	12.8	1.9	0.21
30 %	14.7	14.7	2.1	0.20
35 %	16.8	16.8	2.4	0.20
40 %	18.9	18.9	2.6	0.19
45 %	21.0	21.0	2.9	0.19
50 %	23.3	23.3	3.3	0.19
55 %	25.6	25.6	3.7	0.18

11.6.2.3 MAT PLY

(1) Using UD ply properties in conformity with 11.6.2.1, the (mean) stiffness properties of mat plies can be calculated from:

$$E_1 = E_2 = \left[\frac{(U_1 + U_4) \cdot (U_1 - U_4)}{U_1} \right] \cdot \varphi_{\text{mat}} \quad (11.8)$$

$$G_{12} = \left[\frac{(U_1 - U_4)}{2} \right] \cdot \varphi_{\text{mat}} \quad (11.9)$$

$$\nu_{12} = \frac{U_4}{U_1} \quad (11.10)$$

with:

$$U_1 = \frac{3C_{11} + 3C_{22} + 2C_{12} + 4C_{66}}{8}$$

$$U_4 = \frac{C_{11} + C_{22} + 6C_{12} - 4C_{66}}{8}$$

$$C_{11} = \frac{E_{1UD}}{1 - \nu_{12UD}^2 \cdot \frac{E_{2UD}}{E_{1UD}}}$$

$$C_{22} = \frac{E_{2UD}}{1 - \nu_{12UD}^2 \cdot \frac{E_{2UD}}{E_{1UD}}}$$

$$C_{12} = \frac{\nu_{12UD} \cdot E_{1UD}}{1 - \nu_{12UD}^2 \cdot \frac{E_{2UD}}{E_{1UD}}}$$

$$C_{66} = G_{21UD}$$

The formulas are derived from Manera's equations and φ_{mat} is an empirically defined reduction factor of value 0.91.

(2) For a mat ply on a base of E glass with polyester resin, the typical values given in Table 11.6 can be used.

Table 11.6 - Indicative mat ply E glass stiffness values.

V_f	E_1 [GPa]	E_2 [GPa]	G_{12} [GPa]	ν_{12}
10 %	5.7	5.7	2.1	0.34
12.5 %	6.4	6.4	2.4	0.34
15 %	7.1	7.1	2.6	0.34
17.5 %	7.7	7.7	2.9	0.34
20 %	8.4	8.4	3.2	0.34
25 %	9.8	9.8	3.7	0.34
30 %	11.3	11.3	4.2	0.34

11.6.3 INDICATIVE VALUES FOR PLY STRENGTH PROPERTIES

(1) In case of thermoset fibre reinforced polymers with a fibre volume content of at least 15%, the following can be applied for ply strength:

- for UD plies the values stated in Table 11.4;
- for bi-directional plies the values stated in Table 11.5;
- for mat plies the values stated in Table 11.6.

(2) In case of strain failure in tension, hardened, unreinforced resin should have a strain of at least 1,8%, as stated in EN-ISO 527.

(3) The above assumes that the fibre properties are in conformity with Table 11.1 and that the resin properties are in conformity with Table 11.2.

(4) In the case of FRP, strength is expressed as a strain limit (failure strain).

11.6.4 LINEAR COEFFICIENT OF EXPANSION FOR PLIES

(1) The linear thermal expansion coefficient of UD plies, bi-directional plies or mat plies is calculated from:

$$\alpha_1 = \frac{V_f \alpha_{f1} E_{f1} + V_R \alpha_R E_R}{E_1} \quad (11.11)$$

$$\alpha_2 = \alpha_3 = \alpha_{f2} \sqrt{V_f} + (1 - \sqrt{V_f}) \cdot (1 + V_f V_R E_{f1} / E_1) \cdot \alpha_R \quad (11.12)$$

The equations specified are derived from Chamis formulas. The linear coefficients of thermal expansion of a fibre-reinforced material are dependent on the fibre direction, the fibre volume percentage and the linear coefficient of thermal expansion of the fibre and matrix.

(2) For a ply made of E glass with polyester, typical values can be used as given in:

- for a UD ply: Table 11.7;
- for a bi-directional ply: Table 11.8;
- for a mat ply: Table 11.9.

Table 11.7 - Indicative values for UD plies with E glass, in the plane.

V_f	UD plies			
	$\alpha_{resin} = 50 \cdot 10^{-6} \text{ K}^{-1}$		$\alpha_{resin} = 120 \cdot 10^{-6} \text{ K}^{-1}$	
	$\alpha_1 [\cdot 10^{-6} \text{ K}^{-1}]$	$\alpha_2 [\cdot 10^{-6} \text{ K}^{-1}]$	$\alpha_1 [\cdot 10^{-6} \text{ K}^{-1}]$	$\alpha_2 [\cdot 10^{-6} \text{ K}^{-1}]$
40 %	8.2	27.7	13.0	62.1
45 %	7.7	25.4	1.6	56.3
50 %	7.2	23.2	10.5	50.8
55 %	6.9	21.1	9.6	45.5
60 %	6.6	19.1	8.8	40.4
65 %	6.3	17.1	8.1	35.5
70 %	6.1	15.2	7.5	30.7

Table 11.8 - Indicative values for bi-directional plies with E glass and polyester, in the plane.

V_f	Bi-directional plies			
	$\alpha_{resin} = 50 \cdot 10^{-6} \text{ K}^{-1}$		$\alpha_{resin} = 120 \cdot 10^{-6} \text{ K}^{-1}$	
	$\alpha_1 [\cdot 10^{-6} \text{ K}^{-1}]$	$\alpha_2 [\cdot 10^{-6} \text{ K}^{-1}]$	$\alpha_1 [\cdot 10^{-6} \text{ K}^{-1}]$	$\alpha_2 [\cdot 10^{-6} \text{ K}^{-1}]$
25 %	17.9	17.9	37.2	37.2
30 %	16.1	16.1	32.7	32.7
35 %	14.7	14.7	29.1	29.1
40 %	13.6	13.6	26.2	26.2
45 %	12.6	12.6	23.6	23.6
50 %	11.7	11.7	21.6	21.6
55 %	11.0	11.0	19.6	19.6

Table 11.9 - Indicative values for mat plies with E glass and polyester, in the plane.

V_f	Mat plies			
	$\alpha_{\text{resin}} = 50 \cdot 10^{-6} \text{ K}^{-1}$		$\nu_{\text{resin}} = 120 \cdot 10^{-6} \text{ K}^{-1}$	
	$\alpha_1 [\cdot 10^{-6} \text{ K}^{-1}]$	$\alpha_2 [\cdot 10^{-6} \text{ K}^{-1}]$	$\alpha_1 [\cdot 10^{-6} \text{ K}^{-1}]$	$\alpha_2 [\cdot 10^{-6} \text{ K}^{-1}]$
10 %	28.5	28.5	64.1	64.1
15 %	23.7	23.7	51.9	51.9
20 %	20.5	20.5	43.7	43.7
25 %	18.0	18.0	37.5	37.5
30 %	16.3	16.3	33.1	33.1

11.6.5 COEFFICIENT OF THERMAL CONDUCTIVITY FOR PLYS

(1) The linear coefficient of thermal conductivity of UD plies, bi-directional plies or mat plies can be calculated from:

$$\lambda_1 = V_f \lambda_{f1} + V_R \lambda_R \quad (11.13)$$

$$\lambda_2 = \lambda_3 = (1 - \sqrt{V_f}) \cdot \lambda_R + \frac{\lambda_R \sqrt{V_f}}{1 - \sqrt{V_f} \cdot (1 - \lambda_R / \lambda_{f2})} \quad (11.14)$$

The formulas specified are derived from Chamis. The coefficients of thermal conductivity (λ_1 and λ_2 in the plane and λ_3 perpendicular to the plane) of an FRP are dependent on the type of resin and fibre, fibre direction and the fibre volume percentage.

(2) For a ply on a base of E glass with polyester, typical values can be used as given in:

- for UD plies in Table 11.10;
- for bi-directional plies Table 11.11;
- for mat plies Table 11.12.

Table 11.10 - Indicative values for UD plies of E glass and polyester.

V_f	$\lambda_1 [\text{W/m}\cdot\text{K}]$	$\lambda_2 [\text{W/m}\cdot\text{K}]$
40 %	0.55	0.31
45 %	0.59	0.33
50 %	0.64	0.36
55 %	0.69	0.40
60 %	0.73	0.44
65 %	0.78	0.48
70 %	0.82	0.53

Table 11.11 - Indicative values for bi-directional plies of E glass and polyester.

V_f	λ_1 [W/m·K]	λ_2 [W/m·K]
25 %	0.33	0.33
30 %	0.36	0.36
35 %	0.39	0.39
40 %	0.43	0.43
45 %	0.46	0.46
50 %	0.50	0.50
55 %	0.54	0.54

Table 11.12 - Indicative values for mat plies of E glass and polyester.

V_f	λ_1 [W/m·K]	λ_2 [W/m·K]
10 %	0.24	0.24
15 %	0.27	0.27
20 %	0.30	0.30
25 %	0.33	0.33
30 %	0.36	0.36

11.6.6 SWELLING OF PLIES

(1) If swelling can occur, this should be calculated using the same calculation method as for the thermal expansion. The following applies to the coefficients β_1 and β_2 in the plane and β_3 perpendicular to the plane:

$$\beta_1 = \frac{V_f \beta_{f1} E_{f1} + V_R \beta_R E_R}{E_1} \quad (11.15)$$

$$\beta_2 = \beta_3 = \beta_{f2} \sqrt{V_f} + (1 - \sqrt{V_f}) \cdot (1 + V_f V_R E_{f1} / E_1) \cdot \beta_R \quad (11.16)$$

11.7 LAMINATE PROPERTIES

11.7.1 GENERAL

- (1) Characteristic values for laminate properties can be determined in a number of ways:
- by calculation using the classical laminate theory where the characteristic ply properties in accordance with § 11.6 should be applied;
 - as derived from test results for similar laminates, where a correction should be made for deviating fibre volume content using Table 3.1;

- from tests to determine the characteristic laminate properties as per Table 3.1.
- (2) It is recommended to apply a symmetrical and balanced laminate structure in the design. A non-symmetrical laminate structure would result in torsion deformation under a purely symmetrical tensile load.

11.7.2 STIFFNESS AND STRENGTH

- (1) Assuming the UD ply stiffness stated in §11.6.2 and that classical laminate theory is applied, results in stiffness properties as per Table 11.13.

Table 11.13 - Calculated stiffness values for two different GFRP laminates ($V_f = 50\%$).

Stiffness properties	Quasi-isotropic GFRP laminate 25% 0°/ 25% 90°/ 25% +45°/25% -45°	Anisotropic GFRP laminate 55% 0°/ 15% 90°/ 15% +45°/ 15% -45°
E_1 [GPa]	18.6	25.8
E_2 [GPa]	18.6	15.9
G_{12} [GPa]	7.0	5.6
ν_{12}	0.33	0.32

- (2) The application of the 1.2 % strain limit and 1.6 % shear strain limit results in the following typical strengths for these laminates as shown in Table 11.4.

Table 11.14 - Calculated strength values for two laminates ($V_f = 50\%$).

Strength properties	Quasi-isotropic laminate 50 25% 0°/ 25% 90°/ 25% +45°/25% -45°	Anisotropic laminate 55% 0°/ 15% 90°/ 15% +45°/ 15% -45°
σ_{1tR} [MPa]	223	310
σ_{1cR} [MPa]	223	310
σ_{2tR} [MPa]	223	191
σ_{2cR} [MPa]	223	191
τ_{12R} [MPa]	112	90

11.7.2.1 INTERLAMINAR SHEAR STRENGTH OF LAMINATES (ILSS)

- (1) Typical values can be used as given in Table 11.15 for the interlaminar shear strength (ILSS). Higher values may only be used if these values are based on test results.

Table 11.15 - Typical values for shear strength ILSS in glass fibre reinforced laminates.

Resin type for the GRP laminate	Interlaminar shear strength ILSS [MPa]
Polyester resin	20
Vinyl ester resin	25
Epoxy resin	30

- (2) The values stated in Table 11.15 may also be used as assumed values for carbon laminates.
- (3) A relatively low ILSS value may indicate incompatibility between the resin and fibre or poor conditions during production.

11.7.3 THERMAL EXPANSION FOR LAMINATES

- (1) The linear coefficients of thermal expansion α_1 and α_2 for a laminate that consists of several plies with different fibre directions can be calculated using classical laminate theory.

11.7.4 COEFFICIENT OF THERMAL CONDUCTIVITY FOR LAMINATES

- (1) For a laminate that consists of different plies with different fibre directions, the linear coefficients of thermal expansion α_1 and α_2 , can be calculated using the classical laminate theory.

$$\alpha_{1,Laminate} = \frac{\alpha_{1,1}t_1 + \alpha_{1,2}t_2 + \dots + \alpha_{1,n}t_n}{t_1 + t_2 + \dots + t_n}$$

$$\alpha_{2,Laminate} = \frac{\alpha_{2,1}t_1 + \alpha_{2,2}t_2 + \dots + \alpha_{2,n}t_n}{t_1 + t_2 + \dots + t_n}$$

where t is the layer thickness.

11.7.5 SWELLING OF LAMINATE

- (1) For laminates, the swelling in the plane can be calculated by using the classic laminate theory, as suggested in this appendix.

11.7.6 MATERIAL PROPERTIES FOR FATIGUE ANALYSIS

- (1) In preliminary design for laminates with $35\% \leq V_f \leq 65\%$, the values from Table 11.16 may be used for the fatigue regression parameters when determining the S-N line at ply level in the fibre direction. This only applies to material directions with more than 12.5 % fibre reinforcement.
- (2) As an assumption of the first estimate for the B-value of the tensile-tensile fatigue the static tensile strength can be taken. For all other fatigue loads, the compressive strength of the laminate can be taken.
- (3) For V_f equal to 55 % the S-N curves are shown in Figure 11.1. For other values of V_f a correction should be made.

Table 11.16 - Reference values for regression parameters a and B for UD laminate.

UD non-crimp fabric	Glass/epoxy UD non-crimp fabric	Glass/polyester UD non-crimp fabric	Carbon/epoxy UD non-crimp fabric
	a, B	a, B	a, B
$R = -1$	$-10, 600*(V_f/0.55)$	$-9, 700*(V_f/0.55)$	$-15,900*(V_f/0.55)$
$R = 0.1$	$-10, 1100*(V_f/0.55)$	$-7, 1300*(V_f/0.55)$	$-30, 1200*(V_f/0.55)$
$R = 10$	$-18, 750*(V_f/0.55)$	-	-

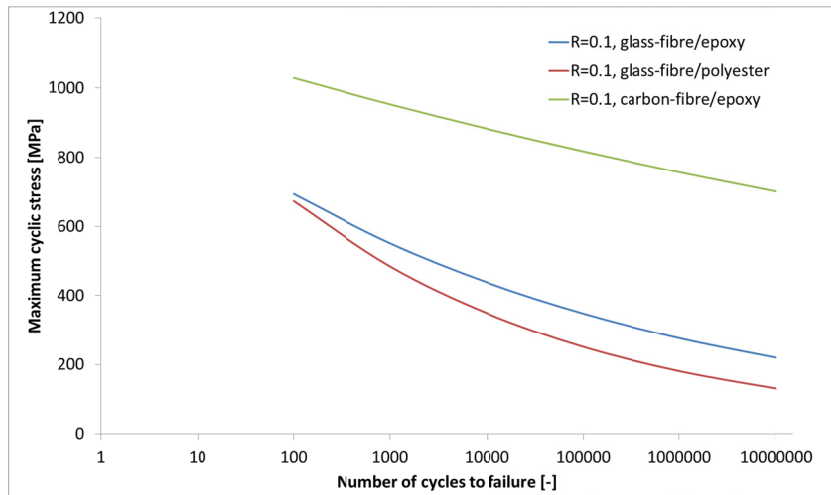

Figure 11.1 - $S-N$ curves for a number of materials, V_f 55%, $R= 0.1$.

11.8 REFERENCES

CUR 96

Fibre Reinforced Polymers in Civil Load Bearing Structures (Dutch Recommendation, 2003).

12 ANNEX C (VALUES OF $N_{C,RD2}$ FOR DOUBLE SYMMETRIC PROFILES)

- (1) In the case of pultruded profiles with double symmetric section, the value $N_{C,RD2}$ is given by:

$$N_{C,RD2} = \chi \cdot N_{loc,Rd}, \quad (12.1)$$

where the design value of compressive force which determines the local instability of the pultruded elements, $N_{loc,Rd}$, can be determined either through tests carried out on large beams (§ 5.5(1)) or numerical/analytical modelling (§ 5.2(4)). As an alternative, it can be obtained from the following relation:

$$N_{loc,Rd} = A \cdot f_{loc,d}^{axial}. \quad (12.2)$$

- (2) In (12.2) the design value of local critical stress, $f_{loc,d}^{axial}$, can be calculated as:

$$f_{loc,d}^{axial} = \frac{\eta_c}{\gamma_M} \cdot \min\{(f_{loc,k}^{axial})_f, (f_{loc,k}^{axial})_w\}, \quad (12.3)$$

where $(f_{loc,k}^{axial})_f$ and $(f_{loc,k}^{axial})_w$ represent the critical stress of the uniformly compressed flanges and web respectively, determinable through the expressions reported in Annex E of this document.

With reference to the symbols in Figure 12.1, the following conservative assumption can be made:

$$(f_{loc,k}^{axial})_f = (f_{loc,k}^{axial})_f^{SS} = 4 \cdot G_{LT} \cdot \left(\frac{t_f}{b_f}\right)^2, \quad (12.4)$$

corresponding to the critical flange stress, simply supported at the connection with the web, $(f_{loc,k}^{axial})_f^{SS}$. In Eq. 12.4 the symbol L means “Longitudinal”, while T means “Transversal”.

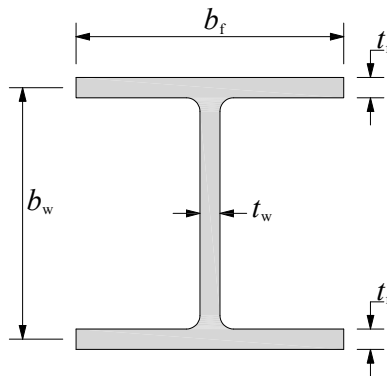

Figure 12.1 – Double symmetric section: symbols used for the geometric dimensions.

(3) The value of the critical stress of the compressed web, $(f_{loc,k}^{axial})_w$, can be determined through the following conservative relation:

$$(f_{loc,k}^{axial})_w = (f_{loc,k}^{axial})_w^{SS} = k_c \cdot \frac{\pi^2 \cdot E_{Lc} \cdot t_w^2}{12 \cdot (1 - \nu_{LT} \cdot \nu_{TL}) \cdot b_w^2}, \quad (12.5)$$

corresponding to the critical stress of the compressed web simply supported at the connection with the flanges, $(f_{loc,k}^{axial})_w^{SS}$. In Eq. 12.5 the symbol c means “compressive”.

(4) The coefficient k_c in (12.5) is obtained from the relation:

$$k_c = 2 \cdot \sqrt{\frac{E_{Tc}}{E_{Lc}}} + 4 \cdot \frac{G_{LT}}{E_{Lc}} \cdot \left(1 - \nu_{LT}^2 \cdot \frac{E_{Tc}}{E_{Lc}}\right) + 2 \cdot \nu_{LT} \cdot \frac{E_{Tc}}{E_{Lc}}. \quad (12.6)$$

(5) For the pultruded profiles classified by EN 13706-3 (Appendix C) the ratio E_{Tc}/E_{Lc} equals approximately 0.30. For pultruded profiles currently available in commerce, the following conditions apply:

- $0.12 \leq G_{LT}/E_{Lc} \leq 0.17$;
- $0.23 \leq \nu_{LT} \leq 0.35$.

For these value intervals, equation (12.6) gives the minimum value $k_c = 1.70$.

(6) The coefficient χ in (12.1) represents a reduction factor which takes into consideration the interaction between the local and global instability of the element. This coefficient assumes a unitary value either due to slenderness which tends to zero or to the presence of constraints which does not allow global instability. The coefficient χ can thus be obtained through the expression:

$$\chi = \frac{1}{c \cdot \lambda^2} \cdot \left(\Phi - \sqrt{\Phi^2 - c \cdot \lambda^2}\right). \quad (12.7)$$

The symbols introduced in (12.7) have the following meaning:

- c represents a numeric coefficient which, in the absence of more accurate tests, can be assumed as equal to 0.65;

$$- \Phi = \frac{1 + \lambda^2}{2}. \quad (12.8)$$

In the above relation slenderness λ is equal to:

$$\lambda = \sqrt{\frac{N_{loc,Rd}}{N_{Eul}}}, \quad (12.9)$$

where

$$N_{Eul} = \frac{\eta_c \cdot \pi^2 \cdot E_{Lc} \cdot I_{min}}{\gamma_M \cdot L_0^2} \quad (12.10)$$

and L_0 is the buckling length of the member.

The value χ , which depends on λ , is plotted in Figure 12.2.

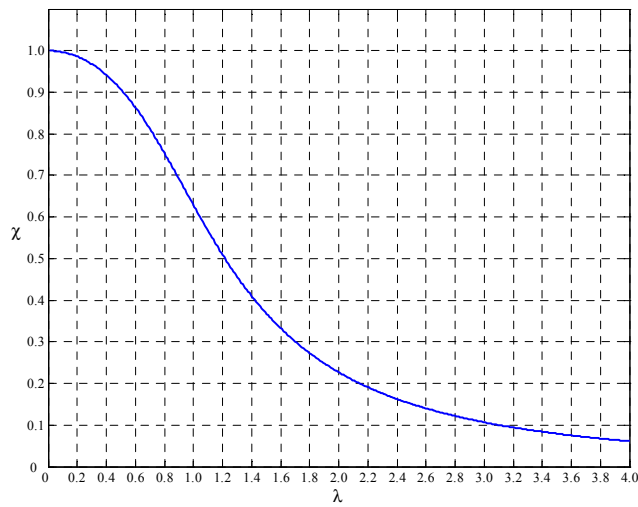

Figure 12.2 – Interaction curve between local and global modes of instability due to axial compression.

12.1 REFERENCES

CNR-DT 205/2007

Guide for the Design and Construction of Structures made of Pultruded FRP elements (Italian National Research Council, October 2008).

13 ANNEX D (VALUES OF M_{RD2} FOR DOUBLE SYMMETRIC PROFILES)

(1) For pultruded profiles with a double symmetric section simply supported through flexure-torsional restraints and subjected to a constant bending moment acting on the plane of maximum inertia of the section, the value of M_{RD2} can be obtained from the relation:

$$M_{RD2} = \chi_{FT} \cdot M_{loc,Rd} \quad (13.1)$$

with $M_{loc,Rd}$ being the design value of the bending moment which determines the local instability of the pultruded element, evaluated through tests carried out on large beams (see § 5.5(1)) or numerical/analytical modelling (see § 5.2(4)). As an alternative, it can be obtained from the following relation:

$$M_{loc,Rd} = W \cdot f_{loc,d}^{flex} \quad (13.2)$$

where W is the profile section modulus.

(2) In (13.2), the design value of the critical stress for flexure, $f_{loc,d}^{flex}$, should be assumed equal to:

$$f_{loc,d}^{flex} = \frac{\eta_c}{\gamma_M} \cdot \min\{(f_{loc,k}^{axial})_f, (f_{loc,k}^{flex})_w\} \quad (13.3)$$

(3) The value of the critical stress of the compressed flange, $(f_{loc,k}^{axial})_f$, can be determined through the expressions reported in Annex E. The value in (12.4) can be assumed for $(f_{loc,k}^{flex})_f$, corresponding to the critical stress of the flange subjected to constant compression and simply supported at the connection with the web.

(4) The value of the critical stress of the web, $(f_{loc,k}^{flex})_w$, can be determined, as a precaution, through the conservative relation:

$$(f_{loc,k}^{flex})_w = (f_{loc,k}^{flex})_w^{SS} = k_f \cdot \frac{\pi^2 \cdot E_{LC} \cdot t_w^2}{12 \cdot (1 - \nu_{LT} \cdot \nu_{TL}) \cdot b_w^2} \quad (13.4)$$

where $(f_{loc,k}^{flex})_w^{SS}$ corresponds to the critical tension of the web subjected to a linear symmetric distribution and simply supported at the connection with the flanges.

(5) In (13.4) the coefficient k_f is calculated as:

$$k_f = 13.9 \cdot \sqrt{\frac{E_{Tc}}{E_{Lc}}} + 22.2 \cdot \frac{G_{LT}}{E_{Lc}} \cdot \left(1 - \nu_{LT}^2 \cdot \frac{E_{Tc}}{E_{Lc}} \right) + 11.1 \cdot \nu_{LT} \cdot \frac{E_{Tc}}{E_{Lc}}. \quad (13.5)$$

(6) For pultruded profiles classified by EN 13706-3 (see Appendix C of this standard), the ratio E_{Tc}/E_{Lc} gives approximately 0.30. Whereas for pultruded profiles currently available in commerce it gives the minimum value $k_f = 11.00$, for the following value intervals:

- $0.12 \leq G_{LT}/E_{Lc} \leq 0.17$
- $0.23 \leq \nu_{LT} \leq 0.35$.

In (13.1) χ_{FT} represents a reduction coefficient which takes into consideration the interaction between the local and global instability of a member subjected to flexure. It is either due to slenderness and assumes a unitary value which tends to zero, or to the presence of restraints which does not allow global instability, and can be obtained from the relation:

$$\chi_{FT} = \frac{1}{c \cdot \lambda_{FT}^2} \cdot \left(\Phi_{FT} - \sqrt{\Phi_{FT}^2 - c \cdot \lambda_{FT}^2} \right). \quad (13.6)$$

(7) The symbols introduced in (13.6) have the following meaning:

- c is a coefficient which, in the absence of a more accurate evaluation, can be assumed to be equal to 0.70;

$$\Phi_{FT} = \frac{1 + \lambda_{FT}^2}{2};$$

$$\lambda_{FT} = \sqrt{\frac{M_{loc,Rd}}{M_{FT}}}.$$

(8) In the definition of the parameter of slenderness, λ_{FT} , reported above, the critical moment due to lateral-torsional instability, M_{FT} , is:

$$M_{FT} = \frac{\eta_c}{\gamma_M} \cdot \frac{\pi^2}{L^2} \cdot E_{Lc} \cdot I_{min} \cdot \sqrt{\frac{I_\omega}{I_{min}} \cdot \left(1 + \frac{G_{LT} \cdot I_t}{E_{Lc} \cdot I_\omega} \cdot \frac{L^2}{\pi^2} \right)}, \quad (13.7)$$

where L is the distance between the ends, I_{min} the minimum value of the moment of inertia, I_t the torsional stiffness factor and I_ω the warping stiffness factor.

(9) The elasticity moduli E_{Lc} and G_{LT} can be determined through three point load tests on samples conforming to the indications set out in Appendix D and Appendix G of EN 13706-2, respectively.

(10) In the case of pultruded profiles with a double symmetric section subjected to a variable bending moment in the plane of maximum inertia, the expression (13.1) of M_{Rd2} can be used to verify the stability. This is valid if the factor λ_{FT} in (13.6) is evaluated assuming that the critical flexure-torsional moment of instability M_{FT} has the following expression:

$$M_{FT} = \frac{\eta_c \cdot C_1}{\gamma_M \cdot k} \cdot \frac{\pi^2}{L^2} \cdot E_{Lc} \cdot I_{\min} \cdot \left[-C_2 \cdot z_q + \sqrt{\left(\frac{C_2 \cdot z_q}{k} \right)^2 + \frac{I_\omega}{I_{\min}} \cdot \left(\frac{1}{k^2} + \frac{G_{LT} \cdot I_t}{E_{Lc} \cdot I_\omega} \cdot \frac{L^2}{\pi^2} \right)} \right] \quad (13.8)$$

where L is the distance between two consecutive flexure-torsional restraints and z_q is the vertical coordinate of the load application point in relation to the centroid of the profile. The values of the coefficients C_1 , C_2 and k are reported in Table 13.1 for several cases of load and constraint.

Table 13.1 – Coefficients C_1 , C_2 and k for several conditions of restraint and load (φ_x , φ_z rotations around the axes x and z ; ψ twisting rotation).

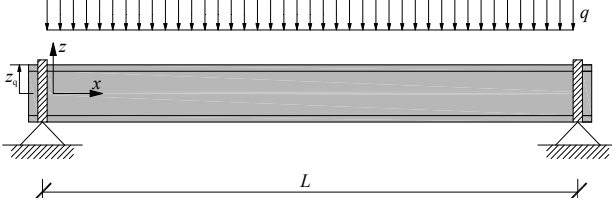
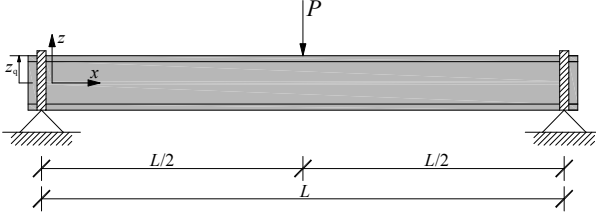
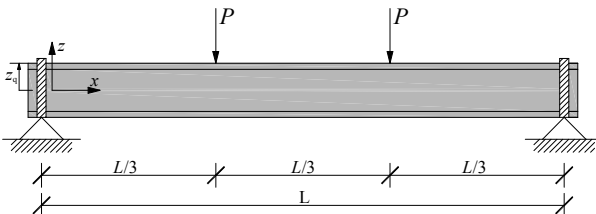
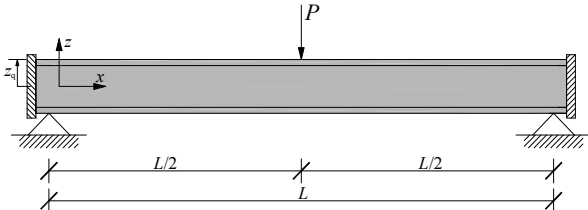
Constraint conditions of the ends and load (on the plane)	φ_x	φ_z	ψ	C_1	C_2	k
	F ^(*)	F	F	1.13	0.45	1.00
	F	F	F	1.35	0.55	1.00
	F	F	F	1.12	0.51	1.00
	F	R ^(**)	R	1.07	0.42	0.50

(*) F = free, (**) R = restrained

(11) In order to verify the local instability of the flanges of double symmetric pultruded profiles simply supported under flexure within the plane of minimum inertia, the design value of the critical bending moment can be evaluated either through tests or numerical/analytical procedures (see § 5.2). In particular, in the case of a constant bending moment, a 2-D model can be used. This will limit the study to the flange subjected at the two extremities to a linear symmetrical distribution of normal stresses and constrained at the connection with the web. This constraint could be modelled as a rotational restraint of stiffness

$$\tilde{k} = \frac{E_{Tc} \cdot t_w^3}{b_w \cdot 12(1 - \nu_{LT} \cdot \nu_{TL})}, \text{ equal to the flexure-stiffness (transversal) of the web.}$$

(12) A further delimitation of the critical load could be obtained assuming that the web represents a simple restraint for the flange ($\tilde{k} = 0$).

13.1 REFERENCES

CNR-DT 205/2007 Guide for the Design and Construction of Structures made of Pultruded FRP elements (Italian National Research Council, October 2008).

14 ANNEX E (LOCAL INSTABILITY OF THE WEB PANEL)

(1) In the case of double T elements in compression (Figure 14.1), the design value of the compressive strength which causes local instability, $N_{loc,Rd}$, can be determined through the following relation:

$$N_{loc,Rd} = A \cdot f_{loc,d}^{axial}, \quad (14.1)$$

Given that:

$$f_{loc,d}^{axial} = \frac{\eta_c}{\gamma_M} \cdot \min\{(f_{loc,k}^{axial})_f, (f_{loc,k}^{axial})_w\}. \quad (14.2)$$

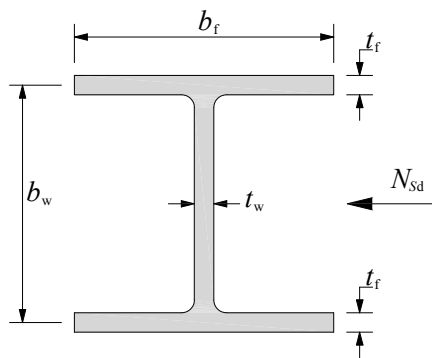

Figure 14.1 – Double T element in compression.

In order to evaluate the critical stress $(f_{loc,k}^{axial})_f$, the following expressions (14.3) and (14.4) take into account the stiffness of the rotational constraint exercised by the web on the flanges (Figure 14.2).

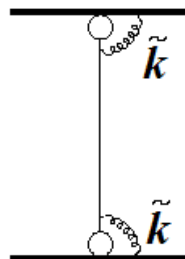

Figure 14.2 – The constraint of the web to the flanges can be represented through rotational springs with stiffness \tilde{k} .

Now the critical stress $(f_{loc,k}^{axial})_f$ can be evaluated as:

$$(f_{loc,k}^{axial})_f = \frac{\sqrt{(D_{11})_f \cdot (D_{22})_f}}{t_f \left(\frac{b_f}{2}\right)^2} \left\{ K \cdot \left[15.1 \cdot \eta \cdot \sqrt{1-\rho} + 6 \cdot (1-\rho) \cdot (1-\eta) \right] + \frac{7 \cdot (1-K)}{\sqrt{1+4.12 \cdot \zeta}} \right\}, \text{ for } K \leq 1 \quad (14.3)$$

$$(f_{loc,k}^{axial})_f = \frac{\sqrt{(D_{11})_f \cdot (D_{22})_f}}{t_f \cdot \left(\frac{b_f}{2}\right)^2} \cdot \left[15.1 \cdot \eta \cdot \sqrt{1-\rho} + 6 \cdot (1-\rho) \cdot (K-\eta) \right], \text{ for } K > 1. \quad (14.4)$$

Quantities ζ , ρ , η and K introduced in (14.3) and (14.4) have the following expressions:

$$\begin{aligned} - \quad \zeta &= \frac{(D_{22})_f}{\tilde{k} \cdot \frac{b_f}{2}}; \\ - \quad \rho &= \frac{(D_{12})_f}{2 \cdot (D_{66})_f + (D_{12})_f}; \\ - \quad \eta &= \frac{1}{\sqrt{1 + (7.22 - 3.55 \cdot \rho) \cdot \zeta}}; \\ - \quad K &= \frac{2 \cdot (D_{66})_f + (D_{12})_f}{\sqrt{(D_{11})_f \cdot (D_{22})_f}}. \end{aligned}$$

(2) The torsional stiffness given by the web, \tilde{k} , (assuming characteristic values of the elasticity moduli) can be represented through the relation:

$$\tilde{k} = \frac{(D_{22})_w}{b_w} \cdot \left[1 - \frac{t_f \cdot (f_{loc,k}^{axial})_f^{SS} \cdot \frac{1}{(E_{Lc})_f \cdot t_f}}{t_w \cdot (f_{loc,k}^{axial})_w^{SS} \cdot \frac{1}{(E_{Lc})_w \cdot t_w}} \right]. \quad (14.5)$$

(3) In the expression (14.5), $(f_{loc,k}^{axial})_f^{SS}$ and $(f_{loc,k}^{axial})_w^{SS}$ represent the critical stresses, relative to the flanges and to the centre of the pultruded element, respectively, corresponding to $\tilde{k} = 0$. They can be evaluated either as in (12.4) and (12.5) or, alternatively, through the following expressions:

$$(f_{loc,k}^{axial})_f^{SS} = \frac{12 \cdot (D_{66})_f}{t_f \cdot \left(\frac{b_f}{2}\right)^2}, \quad (14.6)$$

$$(f_{loc,k}^{axial})_w^{SS} = \frac{\pi^2}{t_w \cdot b_w^2} \cdot \left\{ 2 \cdot \sqrt{(D_{11})_w \cdot (D_{22})_w} + 2 \cdot [(D_{12})_w + 2 \cdot (D_{66})_w] \right\}, \quad (14.7)$$

where the values of flexural stiffness relative to the flanges are obtained from the following relations (assuming characteristic values of the elasticity moduli):

$$D_{11} = \frac{E_{Lc} \cdot t^3}{12 \cdot (1 - \nu_{LT} \cdot \nu_{TL})}, \quad (14.8)$$

$$D_{12} = \nu_{LT} \cdot D_{22}, \quad (14.9)$$

$$D_{22} = \frac{E_{Tc} \cdot t^3}{12 \cdot (1 - \nu_{LT} \cdot \nu_{TL})}, \quad (14.10)$$

$$D_{66} = \frac{G_{LT} \cdot t^3}{12}. \quad (14.11)$$

(4) In order to evaluate the critical stress $(f_{loc,k}^{axial})_w$, the following expression (14.12) takes into account the torsional stiffness ($G I_t$) of the constraint given by the edges in relation to the centre of the pultruded element.

$$(f_{loc,k}^{axial})_w = \frac{\pi^2}{t_w \cdot b_w^2} \cdot \left\{ 2 \cdot \sqrt{1 + 4.139 \zeta^1} \cdot \sqrt{(D_{11})_w \cdot (D_{22})_w} + (2 + 0.62 \cdot \zeta^{12}) \cdot [(D_{12})_w + 2 \cdot (D_{66})_w] \right\}, \quad (14.12)$$

where:

$$- \quad \zeta^1 = \frac{1}{1 + 10 \cdot \zeta^1};$$

$$- \quad \zeta = \frac{(D_{22})_w}{(G I_t) \cdot \frac{b_w}{2}};$$

$$- \quad G I_t = 4 \cdot (D_{66})_f \cdot b_f \cdot \left[\frac{1 - (f_{loc,k}^{axial})_w^{SS} \cdot \left(\frac{1}{E_{Lc} \cdot t_w} \right)}{(f_{loc,k}^{axial})_f^{SS} \cdot \left(\frac{1}{E_{Lc} \cdot t_f} \right)} \right].$$

14.1 REFERENCES

- CNR-DT 205/2007 Guide for the Design and Construction of Structures made of Pultruded FRP elements (Italian National Research Council, October 2008).

15 ANNEX F (INSTABILITY OF ORTHOTROPIC SYMMETRICAL PLATES)

15.1 GENERAL

- (1) The stability of plates and shells should be determined at laminate level.
- (2) If (geometrical) non-linear FEM analysis is used, an initial deformation should be imposed in line with the buckling shape determined using linear FEM analysis.
- (3) As an alternative to a buckling analysis, the verification for stability can be carried out using tests.

15.2 ANALYTICAL SOLUTIONS FOR FLAT PLATES

15.2.1 GENERAL

- (1) For non-symmetrical laminates, the buckling load may be estimated using the equivalent matrix and the classical laminate theory. In the case of short plates, the formulae may be used as a conservative estimate.

15.2.2 PLATES IN COMPRESSION

- (1) The stability of a plate under uniform compression loads should be verified from:



$$\frac{Q_{Ed,c}}{Q_{Rd,c}} \leq 1,0, \quad (15.1)$$

where:

$Q_{Ed,c}$ is the design value for an evenly distributed compression load occurring for each width unit (aligned in the longitudinal direction of the plate);

$Q_{Rd,c}$ is the design value for buckling resistance and $N_{x,cr}$ as indicated below.

- (2) For a plate length L_y the following applies to the characteristic resistance to buckling:

	$N_{x,cr} = \frac{\pi^2}{L_y^2} \left[2\sqrt{D_{11}D_{22}} + 2(D_{12} + 2D_{66}) \right]$
	$N_{x,cr} = \frac{\pi^2}{L_y^2} \left[3.125\sqrt{D_{11}D_{22}} + 2.33(D_{12} + 2D_{66}) \right]$

	$N_{x,cr} = \frac{\pi^2}{L_y^2} \left[4.53 \sqrt{D_{11} D_{22}} + 2.44 (D_{12} + 2D_{66}) \right]$
	$N_{x,cr} = 12 \frac{D_{66}}{L_y^2}$
	$N_{x,cr} = \frac{1}{L_y^2} \sqrt{D_{11} D_{22}} \left[15.1K \sqrt{1-\nu} + 7(1-K) \right] \text{ when } k \leq 1$ $N_{x,cr} = \frac{1}{L_y^2} \sqrt{D_{11} D_{22}} \left[15.1K \sqrt{1-\nu} + 6(K-1)(1-\nu) \right] \text{ when } k > 1$

where:

$$\nu = D_{12} / (2D_{66} + D_{12})$$

$$K = (2D_{66} + D_{12}) / \sqrt{D_{11} D_{22}}$$

The support conditions for the non-supported edges are either simply supported (SS), free or clamped (C).

15.2.3 SHEAR FORCE

(1) The stability of a plate under shear force should be verified from:

$$\frac{Q_{Ed,s}}{Q_{Rd,s}} \leq 1,0 \tag{15.2}$$

where:

$Q_{Ed,s}$ is the design value for shear force for each width unit;

$Q_{Rd,s}$ is the design value for buckling resistance and $N_{xy,cr}$ as indicated below.

(2) For a plate length L_y the following applies to the characteristic resistance to buckling:

	$N_{xy,cr} = \frac{4}{L_y^2} \sqrt{D_{11} D_{22}^3} (8.125 + 5.045k) \text{ when } k \leq 1$ $N_{xy,cr} = \frac{4}{L_y^2} \sqrt{D_{22} (D_{12} + 2D_{66})} \left(11.7 + \frac{1.46}{k^2} \right) \text{ when } k > 1$
--	--

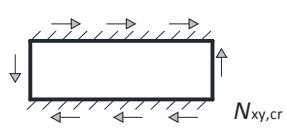
	$N_{xy,cr} = \frac{4}{L_y^2} \sqrt{D_{11} D_{22}^3} (15.07 + 7.08k) \quad \text{when } k \leq 1$ $N_{xy,cr} = \frac{4}{L_y^2} \sqrt{D_{22} (D_{12} + 2D_{66})} \left(18.59 + \frac{3.56}{k^2}\right) \quad \text{when } k > 1$
---	--

15.2.4 PURE BENDING LOAD

(1) The stability of a plate under pure bending should be verified from:



$$\frac{Q_{Ed,b}}{Q_{Rd,b}} \leq 1,0 \quad (15.3)$$

where:

$Q_{Ed,b}$ is the design value for peak load for each width unit;

$Q_{Rd,b}$ is the design value for buckling resistance and $N_{xb,cr}$ as indicated below.

(2) For a plate with length L_y the following applies to the characteristic resistance to buckling:

	$N_{xy,cr} = \frac{\pi^2}{L_y^2} \left[13.4 \sqrt{D_{11} D_{22}} + 10.4 (D_{12} + 2D_{66}) \right]$
	$N_{xy,cr} = \frac{\pi^2}{L_y^2} \left[13.4 \sqrt{D_{11} D_{22}} + 10.4 (D_{12} + 2D_{66}) \right] \quad \text{when } k \leq 3$ $N_{xy,cr} = \frac{4}{L_y^2} \sqrt{D_{22} (D_{12} + 2D_{66})} \left(18.59 + \frac{3.56}{k^2}\right) \quad \text{when } k > 3$

where:

$$K = (2D_{66} + D_{12}) / \sqrt{D_{11} D_{22}}$$

15.2.5 COMBINED LOADS

(1) For a combination of constant compression load, shear force or pure bending, the following interaction formulae may be used. These apply to long orthotropic symmetrical plates with clamped or hinge-supported plate edges.

- For compression with shear:

$$\left(\frac{Q_{Ed,c}}{Q_{Rd,c}} \right) + \left(\frac{Q_{Ed,s}}{Q_{Rd,s}} \right)^{1.9+0.1 \cdot K} \leq 1; \quad (15.4)$$

- For compression with bending:

$$\left(\frac{Q_{Ed,c}}{Q_{Rd,c}} \right) + \left(\frac{Q_{Ed,b}}{Q_{Rd,b}} \right)^2 \leq 1; \quad (15.5)$$

- For bending with shear:

$$\left(\frac{Q_{Ed,b}}{Q_{Rd,b}} \right)^{(13.8+K)/6} + \left(\frac{Q_{Ed,s}}{Q_{Rd,s}} \right)^{(12+K)/6} \leq 1; \quad (15.6)$$

where:

$$K = (2D_{66} + D_{12}) / \sqrt{D_{11}D_{22}}.$$

15.3 REFERENCES

- CUR 96 Fibre Reinforced Polymers in Civil Load Bearing Structures (Dutch Recommendation, 2003).
- Clarke, J.L., *Structural Design of Polymer Composites, Eurocomp Design Code and Handbook* (1996). The European Structural Polymeric Composites Group, E & FN Spon, Chapman & Hall.
- Fokker Technical Handbook TH 3.370, TH 3.372-3.374, 1992.
- Lubin, G., *Handbook of composites* (1982). Van Nostrand Reinhold Company.
- Phillips, L.N., *Design with Advanced Composite Materials, The Design Council* (1989). Springer Verlag.
- ESA, *Structural Materials Handbook* (1994). Vol. 2.
- Tarján, G., Sapkás A. Kollár, L.P. Local Buckling of Composite Beams, 2009. Proceeding of ICCM 17.
- Bank, L. C., *Composites for construction* (2006). J. Wiley & Sons.
- Bleich, F., *Buckling of metal structures* (1952). McGraw-Hill, New York.
- Qiao, P., Davalos, J. F., Wang, J., Local buckling of composite FRP shapes by discrete plate analysis (2001) J. Struct. Eng., Vol. 127 (3), pp. 245-255.
- Timoshenko, S. P., Gere, J. M., *Theory of elastic stability* (1961). McGraw-Hill, New York.

Mottram, J. T., Discussion of Local Buckling of FRP Composite Structural Members with Open and Closed Cross Sections (2004). J. of Structural Engineering.

Mottram, J. T., Determination of critical load for flange buckling in concentrically loaded pultruded columns (2004). Composites Part B: Engineering, Vol. 35 (1), pp. 35-47.

Shan, L. and Qiao, P., Explicit Local Buckling Analysis of Rotationally Restrained Plates under Uniaxial Compression (2008). Engineering Structures, Vol. 30, pp. 136-140.

Veres, I. A., Kollár, L. P., Buckling of orthotropic Plates with different edge supports (2001). Journal of Composite Materials, Vol. 35, pp. 625-635.

Barbero, E. J., *Introduction to composite materials design* (1999). Taylor & Francis, Philadelphia.

16 ANNEX G (SIMPLIFIED CONSTITUTIVE INTERFACE LAWS)

(1) Apart from more rigorous evaluations, the constitutive interface laws can be generally simplified by assimilating the mechanical behaviour of the adhesive to that of two continual series of independent springs (Figure 16.1), with the first one contrasting the relative displacements δ and the other one the relative displacements s . The simplified interface laws, in terms of design values, are presented in Figure 16.2. These diagrams subtend areas equal to those represented by the diagrams in Figure 9.12.

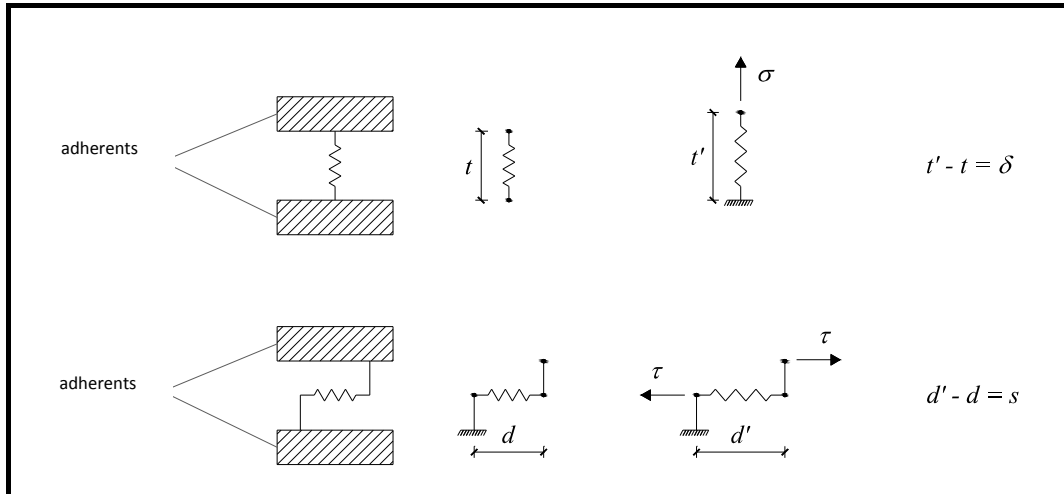

Figure 16.1 – Transversal and longitudinal springs.

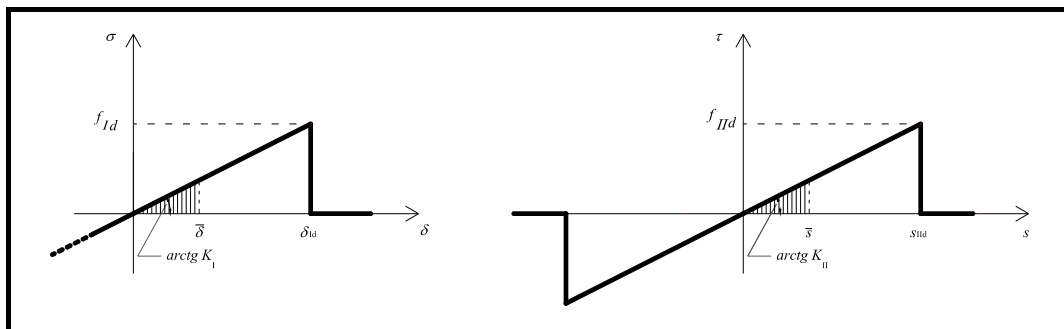

Figure 16.2 – Simplified interface laws.

The first set of springs exercises a normal stress on the interface, which referred to the unit of the surface is:

$$\sigma = k_1 \cdot \delta \quad \text{if } \delta \leq \delta_{id}, \quad (16.1a)$$

$$\sigma = 0 \quad \text{if } \delta > \delta_{id}, \quad (16.1b)$$

in which:

$$k_1 = \frac{f_{Id}}{\delta_{id}}. \quad (16.1c)$$

Analogously, the second set of springs exercises a tangential stress, along the axis of the joint, which referred to the unit of the surface is:

$$\tau = k_{II} \cdot s \quad \text{if } |s| \leq s_{II,d}, \quad (16.2a)$$

$$\tau = 0 \quad \text{if } |s| > s_{II,d}, \quad (16.2b)$$

in which:

$$k_{II} = \frac{f_{II,d}}{s_{II,d}}. \quad (16.2c)$$

16.1 REFERENCES

CNR-DT 205/2007

Guide for the Design and Construction of Structures made of Pultruded FRP elements (Italian National Research Council, October 2008).

17 ANNEX H (FATIGUE TESTING)

17.1 DEFINING AN S-N DIAGRAM BY TESTING

(1) Fatigue tests should be carried out on test specimen of a material that is representative of the application, i.e. the same type of resin and fibres, with equal fibre volume content, and produced according to the same process with identical process parameters.

Test pieces for an application that are produced with a one-sided mould may also be produced with a two-sided mould in order to obtain test pieces with the same surface quality on both sides.

(2) For the choice of *R* value, see the typical values mentioned in Table 17.1.

(3) Static test data may not be used when determining the regression line.

(4) The test piece geometry should be implemented in accordance with Figure 17.1. The thickness should be determined based on the laminate type to prevent buckling.

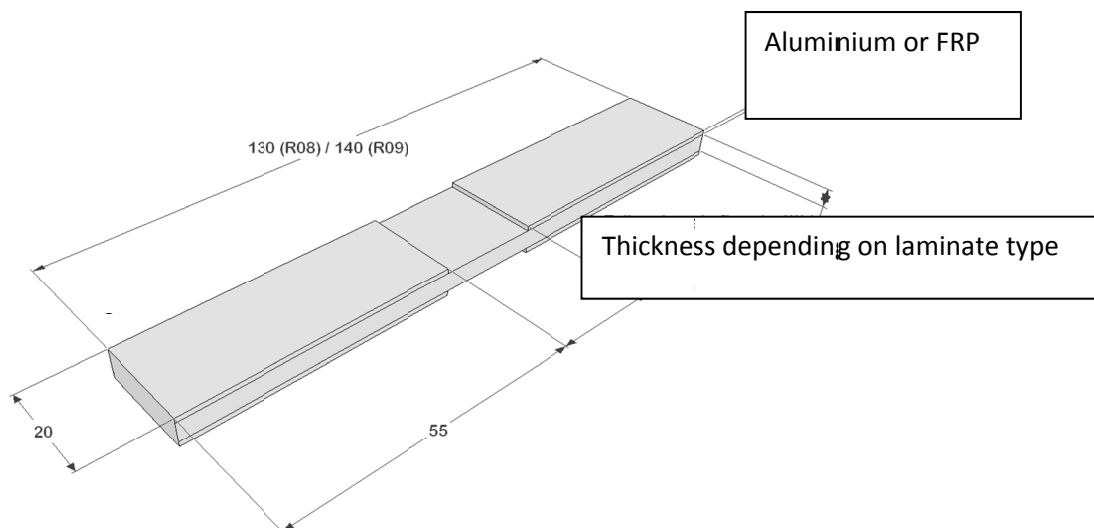

Figure 17.1 - Recommended geometry for fatigue tests (dimensions in mm).

Table 17.1 - Recommended test piece geometry for fatigue tests.

R value	UD, quasi-isotropic
0.1	R08, ISO 527-4
-1	R08, R09
10	R08, R09
Note: the geometry is suitable for laminate thickness up to approx. 5 mm. Glued tabs approx. 1 mm thick are recommended to protect the ends of the test pieces on both sides against the clamping device and to introduce the test load evenly into the test piece	

(5) As a rule the temperature increase, measured at the least favourable location on the surface, may not exceed 5 °C.

(6) The load frequencies depend on the laminate structure and are based in particular on the avoidance of (internal) overheating of the test piece due to viscoelastic effects. Refer to Table 17.2 for guidance on typical frequencies.

Table 17.2 - Recommended test frequencies [Hz].

R value	Nominal life	
	1000	1000000
0.1	2	7
-1	1	3
10	2	7

(7) The data in an S-N diagram should satisfy the following requirements:

- the data has been collected over at least 3 different load levels, the mean life per level differing by a factor of 5 - 10;
- the highest level corresponds to approx. 1000 cycles;
- the lowest level corresponds to approx. $5 \cdot 10^5$ cycles;
- if the operational number of cycles is greater than 10^5 , the lowest load level should be at least one order of magnitude below the number of load cycles expected in operation.
- the distribution over the stress range may be spread uniformly or at discrete levels (at least 3 levels in the latter case), but at the highest and lowest level there should be at least 3 and 2 data points respectively in order to determine the gradient of the S-N curve satisfactorily.

(8) To define an S-N curve from fatigue data, reference is made to 17.1, and for a statistical evaluation to EN1990 Appendix D8.

17.2 CLD DIAGRAMS

(1) If no S-N line is available for the relevant R value, the mean service life should be determined using a constant life diagram. A constant life diagram (CLD) is a diagram in which the permissible number of cycles is shown as a function of the type of load.

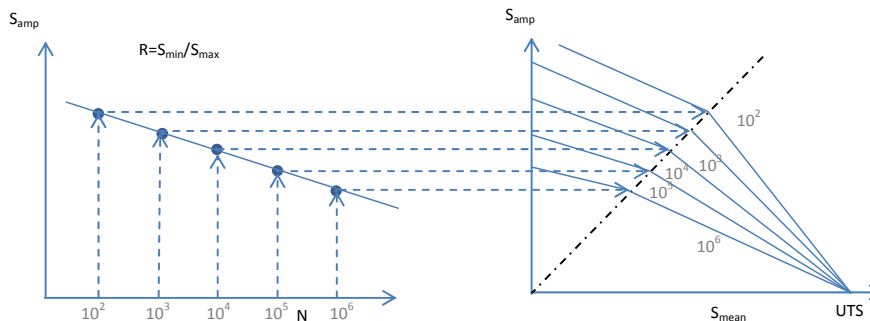

Figure 17.2 - Creating CLD from S-N lines.

The CLD is created by plotting, on a graph with mean stress on the horizontal axis and stress amplitude on the vertical axis, points corresponding to previously chosen lives, differing from each other by a maximum of 1 decade, e.g. 10, 100, 1000, etc. cycles. These points are derived from the available S-N lines.

(2) The characteristic $S-N$ lines should be used for the CLD. The CLD should be constructed by connecting points of the same life to one another. These lines of constant life converge at the tensile strength and the compressive strength.

(3) If only the $S-N$ line at $R=-1$ is known, the linear Goodman diagram may be used as a special case of the CLD. Therefore the linear Goodman diagram is also determined by plotting the stresses corresponding to e.g. 10, 100, 1000 cycles on the vertical axis and connecting these points with the tensile or compressive strength on the horizontal axis.

17.3 REFERENCES

CUR 96, Fibre Reinforced Polymers in Civil Load Bearing Structures (Dutch Recommendation, 2003).

van Delft, D., Joosse, P.A., de Winkel, G.D., Fatigue behaviour of fibreglass wind turbine blade material under variable amplitude loading, paper nr. AIAA-97-0951, 1997.

Dutch Prestandard NVN 11400-0 *Wind turbines part 0: Criteria for type-certification-Technical criteria*, Dutch Normalisation Institute, 1st ed., April 1999.

Europe Direct is a service to help you find answers to your questions about the European Union
Free phone number (*): 00 800 6 7 8 9 10 11
(*) Certain mobile telephone operators do not allow access to 00 800 numbers or these calls may be billed.

A great deal of additional information on the European Union is available on the Internet.
It can be accessed through the Europa server <http://europa.eu>

How to obtain EU publications

Our publications are available from EU Bookshop (<http://bookshop.europa.eu>),
where you can place an order with the sales agent of your choice.

The Publications Office has a worldwide network of sales agents.
You can obtain their contact details by sending a fax to (352) 29 29-42758.

JRC Mission

As the Commission's in-house science service, the Joint Research Centre's mission is to provide EU policies with independent, evidence-based scientific and technical support throughout the whole policy cycle.

Working in close cooperation with policy Directorates-General, the JRC addresses key societal challenges while stimulating innovation through developing new methods, tools and standards, and sharing its know-how with the Member States, the scientific community and international partners.

*Serving society
Stimulating innovation
Supporting legislation*

doi:10.2788/22306

ISBN 978-92-79-54225-1

